



UROLOGIE
UROLOGY
UROLOGIA
UROLOGIE

ELCON
MEDICAL INSTRUMENTS GmbH

ELCON

URO 01 - URO 51

240 - 246

UROLOGIE
UROLOGY
UROLOGIA
UROLOGIE

Die aktuellen Informationen bezüglich der Risikoklasse der ELCON Produkte finden Sie auf unserer Homepage unter „Produkt finden“

You can find the latest information on risk classes of ELCON products on our homepage under “Find product.”

Las informaciones actualizadas sobre la clase de riesgo de los productos ELCON se encuentran en nuestra página web bajo „Buscar producto“

Vous trouverez les informations actuelles concernant la classe de risque des produits ELCON sur notre page d'accueil, sous la rubrique „Trouver un produit“



Grau dargestellte Artikelnummern bezeichnen „distributed by ELCON“ Produkte

Article numbers shown in grey indicate „distributed by ELCON“ products

Los numeros de articulos mostrados en gris indican productos „distribuidos por ELCON“

Les numéros d'articles affichés en gris indiquent les produits „distribués par ELCON“

ELCON 240





..... wide range of top quality instruments

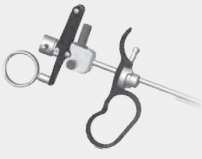
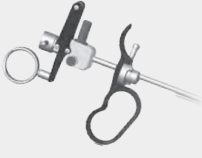

ELCON was founded in the year 1977 by Mr. H.R. Jakobi and a group of professionals with experience of many years in the field of surgical instruments.

All activities and products of ELCON are part of a continuous quality and safety control.

Download certificates at: www.elcon-medical.com

	ÜBERSICHT CONTENTS	CONTENIDO CONTENU	Seite Page
	Endoskope Endoscopes	Endoscopios Endoscopes	1
	Resektoskopie Resectoscopy	Resectoscopia Résectoscopie	2 - 11
	Zystoskopie Cystoscopy	Citoscopia Cystoscopie	12 - 17
	Urethrotomie Urethrotomy	Uretrotomía Uréthrotomie	18 - 21
	Ureterorenoskopie / Nephroskopie Ureterorenoscopy / Nephroscopy	Urterorenoscopia / Nefroscopia Urétérórénoscopie / Néphroscopie	22 - 26
	Allgemeine Instrumente General Instruments	Instrumentos generales Instruments généraux	27 - 30
	Reinigung / Pflege Cleaning / Maintenance	Limpieza / Mantenimiento Nettoyage / Maintenance	31 - 32
	Elektronische Geräte / Zubehör Electronic Units / Accessories	Dispositivos electronicos / Accesorios Dispositifs électroniques / Accessoires	33 - 51

230

230-18-045 – 046	24
230-19-000 – 030	1
230-20-000 – 170	1
230-21-000 – 070	1
230-22-000 – 030	1
230-25-435 – 941	22
230-26-435 – 941	22
230-421-000 – 070	1
230-97-30	31

234

234-00-000 – 010	31
234-11-030 – 100	31

238

238-15-050	36/37
238-15-250 – 301	38/39
238-22-110	40/41
238-22-100	42/43
238-22-300	44/45
238-22-400	46/47
238-30 – 31	48
238-45-005 – 250	34/35
238-70 to 75	51
238-80 to 90	49

240

240-206 – 560	28
240-706 – 764	29
240-151 – 167	29
240-450 – 472	29
240-880 – 902	30

243-01

243-01-02299	8
243-01-02798	2
243-01-02799	2/18

243-04

243-01-02299	8
243-04-02299 – 99/99	8
243-04-02799	3

243-05

243-05-02799	3
--------------	---

243-06

243-06-01999	9
243-06-02497 – 99	4

243-07

243-07-02294 – 99	9
243-07-02487 – 99	4
243-07-02787 – 99	6

243-08

243-08-04099	9
243-08-05099	9
243-08-08099	9

243-09

243-09-01799 – 2599	12
---------------------	----

243-10

243-10-01797 – 2597	12
243-10-01799 – 2599	12

243-11

243-11-00196 – 99	13
-------------------	----

243-12

243-12-00195 – 96	14
243-12-00198 – 99	13

243-13

243-13-00197 – 299	14/15
--------------------	-------

243-14

243-14-05098 – 7098	16
---------------------	----

243-15

243-15-02397 – 99	17
-------------------	----

243-16

243-16-02197	19
243-16-02198	19
243-16-02199	18

243-17

243-17-02199	17
--------------	----

243-19

243-19-00199	19
--------------	----

243-20

243-20-00197 – 99	20
-------------------	----

243-25

243-25-0199 – 2496	26
243-25-0192	24
243-25-0196	25
243-25-1597 – 99	24
243-25-1697 – 99	25
243-25-2197 – 99	25

243-50

243-50-0798 – 99	27
------------------	----

245

245-5045 – 5249	16
245-5062 – 7965	23
245-5405 – 49	26

560

560-051	31
---------	----

561

561-0420-70	22
-------------	----

04

04-BIS-00001 – 00002	11
04-BIS-00003 – 00204	12

04

04-ILO-00001 – 00006	48
----------------------	----

CYSTOSKOPE - RESEKTOSKOPE / CYSTOSCOPES - RESECTOSCOPES
CYSTOSCOPIOS - RESECTOSCOPIOS / CYSTOSCOPES - RESECTOSCOPES

AUTOCLAVE
18 min / 134°C / 273°F



Weitwinkel Endoskope / wide angle endoscopes
endoscopios gran angular / endoscopes grand angle

HD SCOPES

Ø mm	direction of view	working length	
1,9	0°	187 mm	230-19-000
1,9	30°	187 mm	230-19-030
2,7	0°	187 mm	230-20-100
2,7	30°	187 mm	230-20-130
2,7	70°	187 mm	230-20-170
2,7	0°	302 mm	230-20-000
2,7	12°	302 mm	230-20-012
2,7	30°	302 mm	230-20-030
2,7	70°	302 mm	230-20-070
2,9	0°	302 mm	230-22-000
2,9	12°	302 mm	230-22-012
2,9	30°	302 mm	230-22-030

4K UHD SCOPES

Ø mm	direction of view	working length	
4,0	0°	302 mm	230-421-000
4,0	12°	302 mm	230-421-012
4,0	30°	302 mm	230-421-030
4,0	70°	302 mm	230-421-070

! Weitere Endoskope in verschiedenen Durchmessern, Längen und Blickrichtungen können in unserem „Endoskope“ Katalog gefunden werden.

Further Endoscopes in various diameters, lengths and viewing directions can be found in our „Endoscopes“ catalogue

Otros endoscopios con diferentes diámetros, longitudes y direcciones de vista se pueden encontrar en el catálogo „Endoscopes“.

Vous trouverez d'autres endoscopes de divers diamètres, longueurs et directions de vue dans notre catalogue „Endoscopes“.



semiFlex SCOPES

Ø mm	direction of view	working length	
2,7	0°	302 mm	230-20-000SF
2,7	12°	302 mm	230-20-012SF
2,7	30°	302 mm	230-20-030SF
4,0	0°	302 mm	230-21-000SF
4,0	12°	302 mm	230-21-012SF
4,0	30°	302 mm	230-21-030SF
4,0	70°	302 mm	230-21-070SF

**RESEKTOSKOP ARBEITSELEMENTE, ERWACHSENE
RESECTOSCOPE WORKING ELEMENTS, ADULT
RESECTOSCOPIO ELEMENTO DE TRABAJO, ADULTOS
RESECTOSCOPE ELEMENTS DE TRAVAIL, ADULTES**

für Endoskope Ø 4,0 mm, 0° / 30° mit 300 mm Arbeitslänge
for endoscopes Ø 4,0 mm, 0° / 30° with 300 mm working length
para endoscopios Ø 4,0 mm, 0° / 30° con 300 mm longitud de trabajo
pour endoscopes Ø 4,0 mm, 0° / 30° avec longueur de travail 300 mm



PASSIV, Elektrode in Ruhestellung innerhalb des Schaftes
PASSIVE, electrode in rest position inside of the sheath
PASIVO, electrodo en posición de reposo en el interior del tubo
PASSIF, électrode en position de pause à l'intérieur du manche

Aluminium,
handle black coated

Arbeitselement für 24 Ch / 27 Ch. Schaft
working element for 24 Ch / 27 Ch. sheath
elemento de trabajo para tubo 24 Ch / 27 Ch.
élément de travail pour manche de 24 Ch / 27 Ch.

243-01-02799



AKTIV, Elektrode in Ruhestellung außerhalb des Schaftes
ACTIVE, electrode in rest position outside of the sheath
ACTIVO, electrodo en posición de reposo en el exterior del tubo
ACTIF, électrode en position de pause à l'extérieur du manche

Aluminium,
handle black coated

Arbeitselement für 24 Ch / 27 Ch. Schaft
working element for 24 Ch / 27 Ch. sheath
elemento de trabajo para tubo 24 Ch / 27 Ch.
élément de travail pour manche de 24 Ch / 27 Ch.

243-01-02798

RESEKTOSKOPSCHÄFTE ZUR DAUERSPÜLUNG 24 CH.
RESECTOSCOPE SHEATHS FOR CONTINUOUS IRRIGATION 24 CH.
TUBOS DE RESECTOSCOPIA PARA IRRIGACION CONTINUA 24 CH.
MANCHES POUR RESECTOSCOPIE POUR IRRIGATION CONTINUE 24 CH.

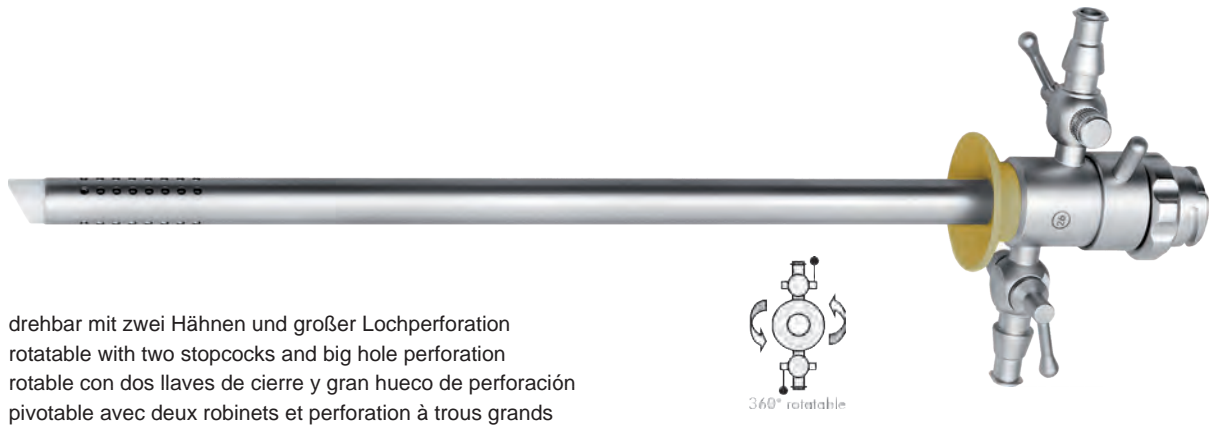

drehbar mit zwei Hähnen und großer Lochperforation
rotatable with two stopcocks and big hole perforation
rotable con dos llaves de cierre y gran hueco de perforación
pivotable avec deux robinets et perforation à trous grands



360° rotatable

	colour code	
inner / outer sheath 24 Ch. / 26 Ch., 30° ceramic tip	yellow	243-04-02799
inner / outer sheath including standard obturator	yellow	243-04-2799-00

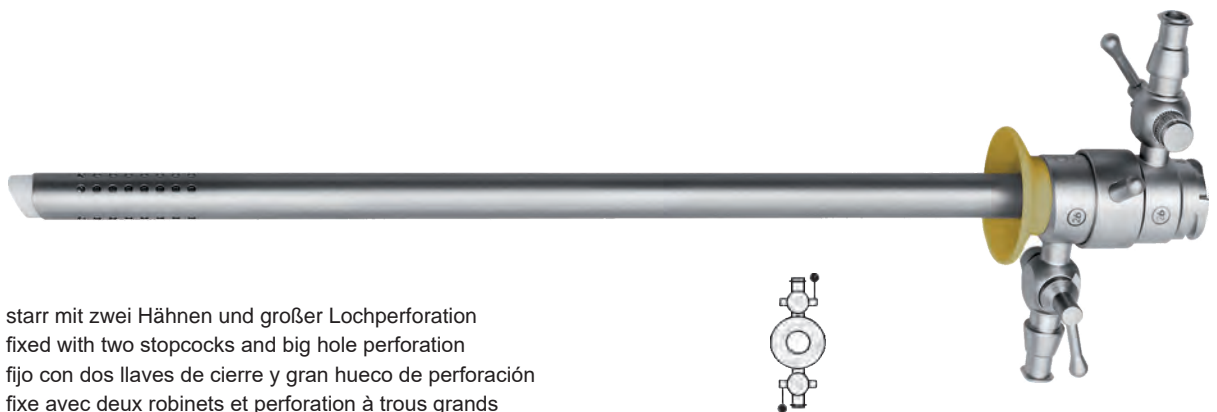

starr mit zwei Hähnen und großer Lochperforation
fixed with two stopcocks and big hole perforation
fijo con dos llaves de cierre y gran hueco de perforación
fixe avec deux robinets et perforation à trous grands



	colour code	
inner / outer sheath 24 Ch. / 26 Ch., 30° ceramic tip	yellow	243-05-02799
inner / outer sheath including standard obturator	yellow	243-05-2799-00

OBTURATOREN für Schäfte 24 Ch. / **OBTURATORS** for use with sheaths, 24 Ch.
OBTURADORES para tubos 24 Ch. / **OBTURATEURS** pour manches 24 Ch.



standard

colour code, yellow

243-06-02499



visual obturator

243-06-02497

MONOPOLAR ELEKTRODEN 24 Ch. für Resektoskope 24 Ch.
MONOPOLAR ELECTRODES 24 Ch for Resectoscopes 24 Ch.
ELECTRODOS MONOPOLAR 24 Ch. para resectoscopios 24 Ch.
ELECTRODES MONOPOLAIRES 24 Ch. pour résectoscopes 24 Ch.



Slit electrode

243-07-02499

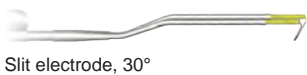

Slit electrode, 30°

243-07-02498



Slit electrode, 0°

243-07-02497



Knife electrode

243-07-02496

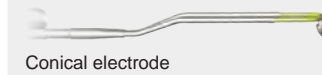

Conical electrode

243-07-02495



Ball electrode

5 mm

243-07-02493

3 mm

243-07-02494



Roller electrode

5 mm

243-07-02491

3 mm

243-07-02492

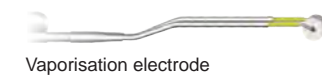

Vaporisation electrode

5 mm

243-07-02487

3 mm

243-07-02488

Laser Resectoscope expected in 2025

Laser Resectoscope expected in 2025

Laser Resectoscope expected in 2025

**RESEKTOSKOP ARBEITSELEMENTE, ERWACHSENE
RESECTOSCOPE WORKING ELEMENTS, ADULT,
RESECTOSCOPIO ELEMENTOS DE TRABAJO, ADULTOS
RESECTOSCOPE ELEMENTS DE TRAVAIL, ADULTES**

für Endoskope Ø 2,7 und 2,9 mm, 0° / 30° mit 300 mm Arbeitslänge
for endoscopes Ø 2,7 and 2,9 mm, 0° / 30° with 300 mm working length
para endoscopios Ø 2,7 y 2,9mm 0° / 30° con 300mm longitud de trabajo
pour endoscopes Ø 2,7 et 2,9mm 0° / 30° avec longueur de travail 300mm

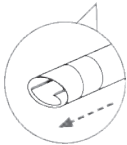

PASSIV, Elektrode in Ruhestellung innerhalb des Schaftes
PASSIVE, electrode in rest position inside of the sheath
PASIVO, electrodo en posición de reposo en el interior del tubo
PASSIF, électrode en position de pause à l'intérieur du manche

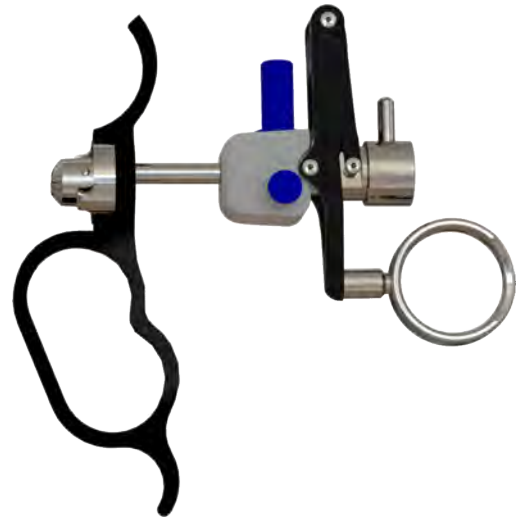

Aluminium,
handle black coated

Arbeitselement für 19 Ch. Schaft
working element for 19 Ch. sheath
elemento de trabajo para tubo 19 Ch.
élément de travail pour manche 19 Ch.

243-01-02299

**RESEKTOSKOPSCHÄFTE ZUR DAUERSPÜLUNG 19 CH.
RESECTOSCOPE SHEATHS FOR CONTINUOUS IRRIGATION 19 CH.
TUBOS DE RESECTOSCOPIA PARA IRRIGACION CONTINUA 19 CH.
MANCHES POUR RESECTOSCOPIE POUR IRRIGATION CONTINUE 19 CH.**

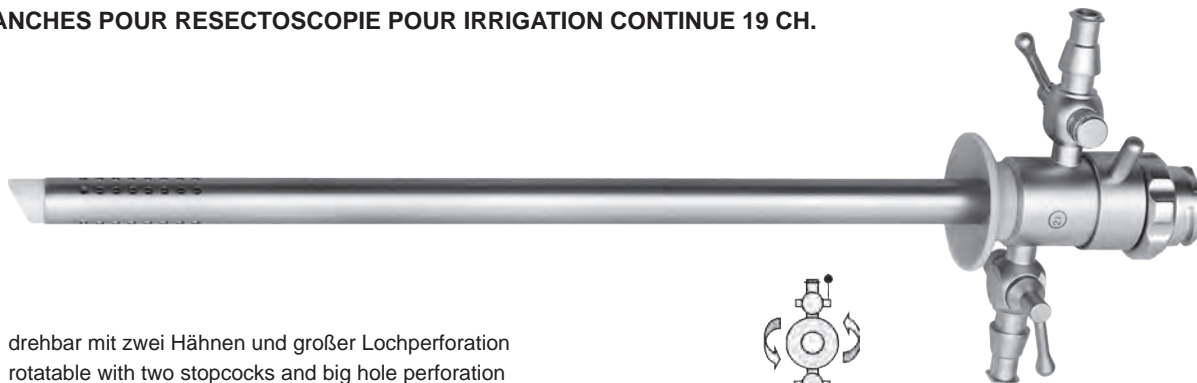

drehbar mit zwei Hähnen und großer Lochperforation
rotatable with two stopcocks and big hole perforation
rotable con dos llaves de cierre y gran hueco de perforación
pivotable avec deux robinets et perforation à trous grands



360° rotatable

	colour code	
inner / outer sheath 19/21 Ch., 30° ceramic tip	white	243-04-2299
inner / outer sheath including standard obturator	white	243-04-2299-00

OBTURATOREN für Schäfte 19 Ch. / **OBTURATORS** for use with sheaths, 19 Ch.
OBTURADORES para tubos 19 Ch. / **OBTURATEURS** pour manches 19 Ch.



standard	colour code, white	243-06-01999
----------	--------------------	--------------

MONOPOLAR ELEKTRODEN 19 Ch. für Resektoskope 19 Ch.
MONOPOLAR ELECTRODES 19 Ch for resectoscopes 19 Ch.
ELECTRODOS MONOPOLAR 19 Ch para resectoscopios 19 Ch.
ELECTRODES MONOPOLAIRES 19 Ch. pour résectoscopes 19 Ch.

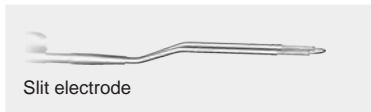

243-07-02299

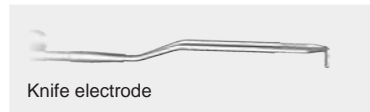

243-07-02296

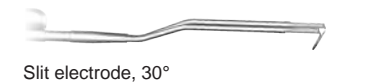

243-07-02298



3 mm 243-07-02294

HOCHFREQUENZKABEL / HF CABLE / CABLES AF / CABLE HF

für Resektoskop Arbeitselemente / for resectoscope working elements /
para elemento de trabajo resectoscopio / pour éléments de travail résectoscopiques



Erbe T, Berchtold, Martin, 4 mm

3 m

243-08-04099



Storz, Erbe, 5 mm

3 m

243-08-05099



Valleylab, Bowie, 8 mm

3 m

243-08-08099

**RESEKTOSKOP BIPOLAR, ERWACHSENE
RESECTOSCOPE BIPOLAR, ADULT
RESECTOSCOPIO BIPOLARES, ADULTOS
RESECTOSCOPE BIPOLAIRES, ADULTES**

für Endoskope Ø 4,0 mm, 0° / 30° mit 300 mm Arbeitslänge
for endoscopes Ø 4,0 mm, 0° / 30° with 300 mm working length
para endoscopios Ø 4,0 mm, 0° / 30° con 300 mm longitud de trabajo
pour endoscopes Ø 4,0 mm, 0° / 30° avec longueur de travail 300 mm

*auf Anfrage! eingeschränkte Verfügbarkeit
on request! limited availability
bajo pedido! disponibilidad limitada
sur demande! disponibilité limitée*

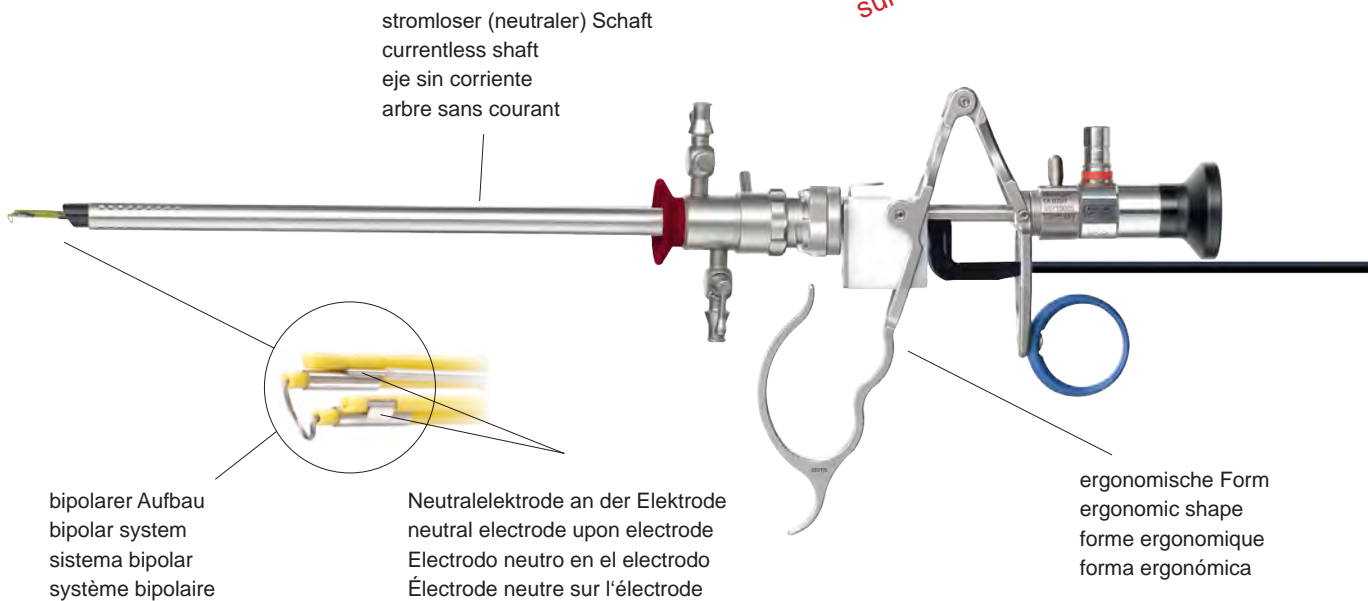

- + Stromloser Schaft / Current free sheath
- + Keine unbeabsichtigte Gewebekoagulation durch zweite Elektrode
No accidental tissue coagulation by second electrode
- + Elektrizität ausschließlich im Op Feld /
Electrical current flow limited to the operating field
- + Hervorragendes Anschnitt und Koagulationsverhalten durch den geringen Elektrodenabstand zwischen aktiver und Neutralelektrode /
Excellent ignition, cutting and coagulation performance

- + Kein TUR Syndrom Risiko durch die Verwendung von NaCl /
No TUR syndrome risk through use of NaCl
- + Einfacher Elektrodenwechsel / Easy to replace electrodes
- + Generatoren/Optik und Schaft unabhängig (offenes System)
Generators/optics and sheath independent (open system)
- + Wiederverwendbare Elektroden / Reusable electrodes
- + Kabel mit nur einem Anschluss / Single bipolar connector
- + Ergonomischer Handgriff / Ergonomic handle

ARBEITSELEMENT / WORKING ELEMENT

	<p>PLASMALoop Arbeitselement bipolar, passiv PLASMALoop working element bipolar, passive</p>	<p>04-BIS-00001</p>
	<p>PLASMALoop Arbeitselement bipolar, aktiv PLASMALoop working element bipolar, active</p>	<p>04-BIS-00002</p>

DAUERSPÜLSCHAFT 24 CH. / CONTINUOUS FLOW SHEATH 24 CH.



PLASMALOOP Dauerspülschaft mit 2 Hähnen, 24 Ch.
 PLASMALOOP Continuous flow sheath with 2 stopcocks
 for in- and outflow, 24 Ch.

04-BIS-00003

DAUERSPÜLSCHAFT 26 CH. / CONTINUOUS FLOW SHEATH 26 CH.



Aussenschaft mit 2 Hähnen, drehbar, 26 Ch.
 exterior tube with 2 stopcocks for in- and outflow,
 rotatable, 26 Ch.

04-BIS-00005



Innenschaft mit Keramikspitze, drehbar, 24 Ch.
 interior tube with ceramic tip, rotatable, 24 Ch.

04-BIS-00006

OBTURATOR / OBTURATOR

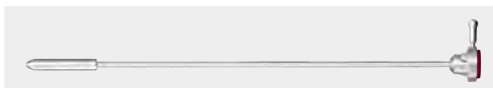

Obturator
 Obturator

04-BIS-00007



Sichtobturator
 Visual Obturator

04-BIS-00049

BIPOLARE ELECTRODEN / BIPOLAR ELECTRODES



Loop electrode 90°

04-BIS-00008



Loop electrode 0°

04-BIS-00011



Loop electrode 60°

04-BIS-00009



Knife electrode

04-BIS-00012



Ball electrode

04-BIS-00010



Roller electrode

04-BIS-00013



Vaporisation electrode

04-BIS-00050

HOCHFREQUENZKABEL BIPOLAR / HF CABLE BIPOLAR / CABLES AF BIPOLARES / CABLE HF BIPOLAIRES

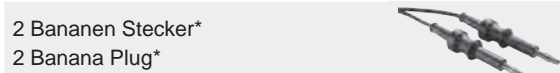

2 Bananen Stecker*
 2 Banana Plug*

400 cm

04-BIS-00200



Valleylab / Lamidey /
 Bowa

400 cm

04-BIS-00201

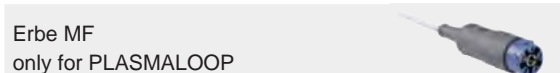

Erbe MF
 only for PLASMALOOP

400 cm

04-BIS-00202

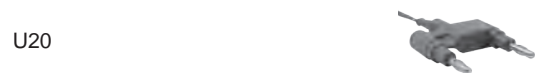

U20

400 cm

04-BIS-00203

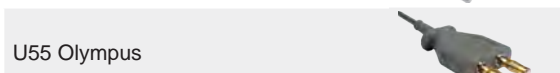

U55 Olympus

400 cm

04-BIS-00204

*Entspricht nicht den EU-Bestimmungen / *Non-compliant with EU standards /

*No cumple con las normas UE / *Non conforme aux normes UE

**ZYSTOSKOPIESCHÄFTE, ERWACHSENE
CYSTOSCOPY SHEATHS, ADULT
TUBOS DE CITOSCOPIA, ADULTOS
MANCHES POUR CYSTOSCOPIE, ADULTES**

für Endoskope Ø 4,0 mm, 0° / 30° mit 300 mm Arbeitslänge
for endoscopes Ø 4,0 mm, 0° / 30° with 300 mm working length
para endoscopios Ø 4,0 mm, 0° / 30° con 300 mm longitud de trabajo
pour endoscopes Ø 4,0 mm, 0° / 30° avec longueur de travail 300 mm

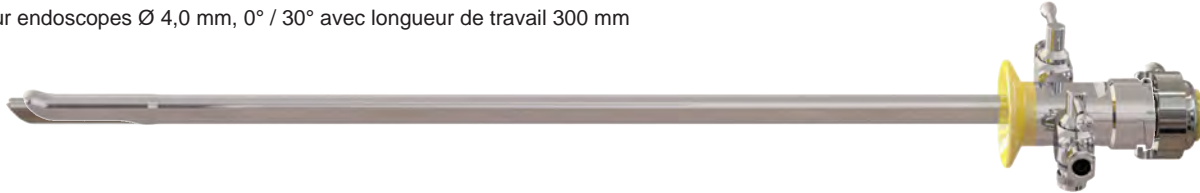

	Ch.	colour code	
	17	yellow	243-09-1799-00
	19	green	243-09-1999-00
	20	red	243-09-2099-00
	22	blue	243-09-2299-00
	25	white	243-09-2599-00

Cystoskop Schaft komplett mit Obturator
Cystoscopy sheath complete with Obturator
Tubos de Citoscopia completo con obturador
Manches pour Cystoscopie complet avec Obturateur

**SCHÄFTE ALLEINE / SHEATHS, ONLY
SOLO TUBOS / SEUL MANCHES**



Sheath Ch.	colour code	
17	yellow	243-09-01799
19	green	243-09-01999
20	red	243-09-02099
22	blue	243-09-02299
25	white	243-09-02599

**OBTURATOREN ALLEINE / OBTURATORS ONLY
SOLO OBTURADORES / SEUL OBTURATEURS**



Obturator Ch.	colour code	
17	yellow	243-10-01799
19	green	243-10-01999
20	red	243-10-02099
22	blue	243-10-02299
25	white	243-10-02599

**SICHTOBTURATOREN FÜR ZYSTOSKOPIESCHÄFTE / VISUAL OBTURATORS FOR CYSTOSCOPE SHEATHS
OBTURADORES VISUAL PARA TUBOS DE CITOSCOPIA / OBTURATEURS VISUAL POUR MANCHES CYSTOSCOPIE**



sheath Ch.	colour code		sheath Ch.	colour code	
17	yellow	243-10-01797	22	blue	243-10-02297
19	green	243-10-01997	25	white	243-10-02597
20	red	243-10-02097			

ARBEITSELEMENT MIT ALBARRAN-DEFLECTOR
WORKING ELEMENT WITH ALBARRAN-DEFLECTOR
ELEMENTO DE TRABAJO CON ALBARRAN-DEFLECTOR
ELEMENTS DE TRAVAIL AVEC ALBARRAN-DEFLECTOR

mit 1 Instrumentenkanal
 with 1 instrument channel
 con 1 canal de instrumento
 avec 1 canal d'instrument

243-12-00199



mit 2 Instrumentenkanälen
 with 2 instrument channels
 con 2 canales para instrumentos
 avec 2 canaux d'instrument

243-12-00198

OPTIKBRÜCKEN / TELESCOPE BRIDGES
BRIDGE TELESCOPIO / PONT TELESCOPE

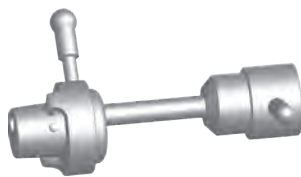

Diagnostik
 Diagnostic
 Diagnóstico
 Diagnosis

243-11-00199

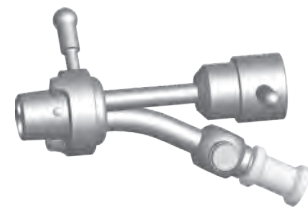

mit 1 Instrumentenkanal
 with 1 instrument channel
 con 1 canal de instrumento
 avec 1 canal d'instrument

243-11-00198

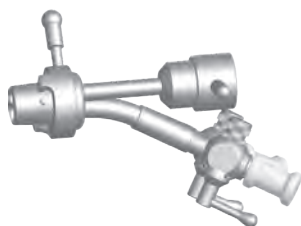

mit 2 Instrumentenkanälen
 with 2 instrument channels
 con 2 canales para instrumentos
 avec 2 canaux d'instrument

243-11-00197



Zystoskopie Adapter, Frauen
 Cystoscopy adapter, female
 adaptador Citoscopia, femenino
 adaptateur Cystoscopie, femmes

243-11-00196

KAPAZITÄT DER ZYSTOSKOPIE SCHÄFTE zur Bestimmung des Ø der flexiblen Instrumente
CYSTOSCOPY SHEATHS CAPACITY for determining the Ø of flexible instruments
CAPACIDAD DE TUBOS DE CITOSCOPIA para determinar el Ø de los instrumentos flexibles
CAPACITE DE MANCHES CYSTOSCOPE pour déterminer le Ø des instruments flexibles

	17 Ch.	19 Ch.	20 Ch.	22 Ch.	25 Ch.
Sheath size					

Telescope Bridge
with one instrument
channel

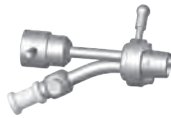

1 Instrument Ø 5 Ch.	1 Instrument Ø 6 Ch.	1 Instrument Ø 7 Ch.	1 Instrument Ø 10 Ch.	1 Instrument Ø 12 Ch.
-------------------------	-------------------------	-------------------------	--------------------------	--------------------------

Telescope Bridge
with two instrument
channels



1 Instrument Ø 5 Ch.	1 Instrument Ø 6 Ch.	1 Instrument Ø 7 Ch.	1 Instrument Ø 10 Ch.	1 Instrument Ø 12 Ch.
	2 Instruments Ø 5 Ch.	2 Instruments Ø 6 Ch.	2 Instruments Ø 7 Ch.	2 Instruments Ø 8 Ch.

Albarran-Deflector
with one instrument
channel



1 Instrument Ø 5 Ch.	1 Instrument Ø 6 Ch.	1 Instrument Ø 9 Ch.	1 Instrument Ø 10 Ch.
-------------------------	-------------------------	-------------------------	--------------------------

Albarran-Deflector
with two instrument
channels



1 Instrument Ø 5 Ch.	1 Instrument Ø 6 Ch.	1 Instrument Ø 9 Ch.	1 Instrument Ø 12 Ch.
	2 Instruments Ø 4 Ch.	2 Instruments Ø 5 Ch.	2 Instruments Ø 8 Ch.





OPTISCHE INSTRUMENTE, STARR zur verwendung mit Zystoskopie Schaft 25 Ch.
OPTICAL INSTRUMENTS, RIGID for the use with cystoscopy sheath 25 Ch.
INSTRUMENTOS OPTICO, RIGIDO para el uso con tubos de citoscopia 25 Ch.
INSTRUMENTS OPTIQUE, RIGIDE pour l'utilisation avec manches pour cystoscopie 25 Ch.



	Steinfasszange Stone grasping forceps	243-13-00298
---	--	---------------------

OPTISCHE INSTRUMENTE, STARR zur verwendung mit Zystoskopie Schaften 20-25 Ch.
OPTICAL INSTRUMENTS, RIGID for the use with cystoscopy sheaths 20-25 Ch.
INSTRUMENTOS OPTICO, RIGIDO para el uso con tubos de citoscopia 20-25 Ch.
INSTRUMENTS OPTIQUE, RIGIDE pour l'utilisation avec manches pour cystoscopie 20-25 Ch.



	sample excision forceps, double action with short jaws	243-13-00197
	grasping forceps, double action	243-13-00299
	hook scissors, double action	243-13-00297
	biopsy punch, through-cutting, double action	243-13-00198
	biopsy forceps, double action	243-13-00196

FLEXIBLE INSTRUMENTE / FLEXIBLE INSTRUMENTS
INSTRUMENTOS FLEXIBLES / INSTRUMENTS FLEXIBLES

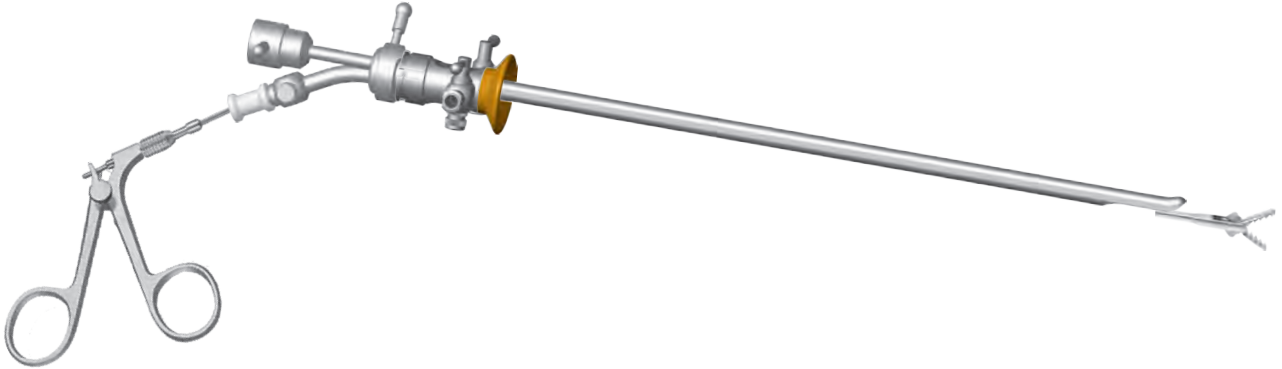

LENGTH 400 MM		Ch.	Ø mm	
	Biopsie, doppelbeweglich	5	1,6	245-5045
	biopsy, double action	7	2,3	245-5047
	biopsia, doble acción	9	3,0	245-5049
	biopsie, action double			
	Biopsie, gezahnt, doppelbeweglich	5	1,6	245-5345
	biopsy, toothed, double action	7	2,3	245-5347
	biopsia, dentada, doble accion	9	3,0	245-5349
	biopsie, dentelée; action double			
	Alligator, Fasszange, doppelbeweglich	5	1,6	245-5145
	Alligator, grasping forceps, double action	7	2,3	245-5147
	Alligator, pinza de aprehension, doble accion	9	3,0	245-5149
	Alligator, pince à préhension, action double			
	Schere, einzelbeweglich, stumpf	5	1,6	245-5245
	scissors, single action, blunt	7	2,3	245-5247
	tijera, simple accion, roma	9	3,0	245-5249
	ciseaux, action simple, mousse			
	Hakenschere, einzelbeweglich, stumpf	7	2,3	245-5227
	hook scissors, single action, blunt	9	3,0	245-5229
	tijera de gancho, simple accion, roma			
	ciseaux crochet, action simple, mousse			
	Schere, doppelbeweglich, stumpf	7	2,3	245-5237
	scissors, double action, blunt			
	tijera, doble accion, roma			
	ciseaux, action double, mousse			

LASER ZYSTOSKOPIESCHÄFTE, ERWACHSENE
LASER CYSTOSCOPY SHEATHS, ADULT
LASER TUBOS DE CITOSCOPIA, ADULTOS
LASER MANCHES POUR CYSTOSCOPIE, ADULTES

für Endoskope Ø 4,0 mm, 0° / 30° mit 300 mm Arbeitslänge
 for endoscopes Ø 4,0 mm, 0° / 30° with 300 mm working length
 para endoscopios Ø 4,0 mm, 0° / 30° con 300 mm longitud de trabajo
 pour endoscopes Ø 4,0 mm, 0° / 30° avec longueur de travail 300 mm

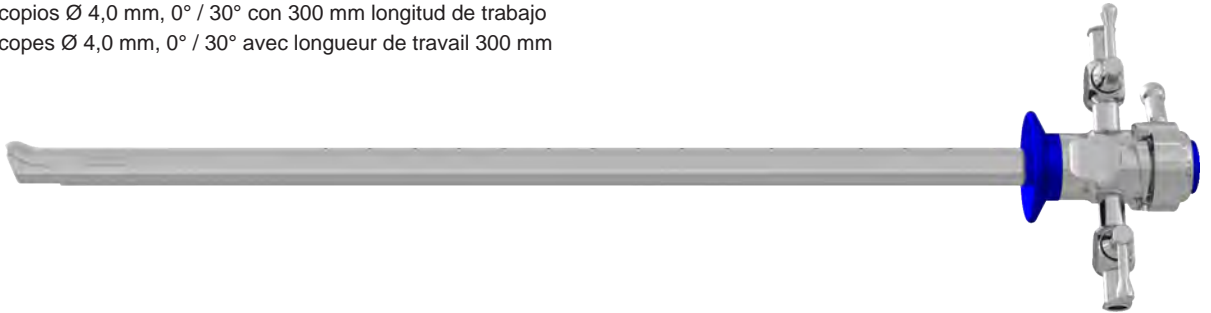

	colour code	
laser cystoscopy sheath / 23 Ch.	blue	243-15-02399
laser cystoscopy sheath including standard obturator / 23 Ch.	blue	243-15-2399/00

SICHTOBTURATOREN / VISUAL OBTURATORS / OBTURADORS VISUAL / OBTURATEURS VISUAL



für 23 Ch. Schaft / for 24 Ch. sheath / para tubo 23 Ch. / pour manche de 23 Ch.	243-15-02398
--	--------------

LASER ARBEITSEINSATZ / LASER WORKING INSERT
INSERCIÓN DE TRABAJO LÁSER / INSERT DE TRAVAIL LASER



mit einem Arbeitskanal 8 Ch. für 23 Ch. Schaft / with one working channel 8 Ch. for 23 Ch. sheath con 1 canal de trabajo 8 Ch. para tubo 23 Ch. / avec 1 canal de travail 8Ch. pour manche de 23 Ch.	243-15-02397
---	--------------

**URETHROTOM ARBEITSELEMENTE, ERWACHSENE
URETHROTOME WORKING ELEMENTS, ADULT
URETHROTOMO ELEMENTO DE TRABAJO, ADULTOS
URETHROTOME ELEMENTS DE TRAVAIL, ADULTES**

für Endoskope Ø 4,0 mm, 0° / 30° mit 300 mm Arbeitslänge / for endoscopes Ø 4,0 mm, 0° / 30° with 300 mm working length
para endoscopios Ø 4,0 mm, 0° / 30° con 300 mm longitud de trabajo / pour endoscopes Ø 4,0 mm, 0° / 30° avec longueur de travail 300 mm



PASSIV, Messer in Ruhestellung innerhalb des Schaftes
PASSIVE, knife in rest position inside of the sheath
PASIVO, cuchillo en posición de reposo en el interior del tubo
PASSIF, lames en position de pause à l'intérieur du manche

Aluminium,
handle black coated

Arbeitselement für 21 Ch. Schaft / working element for 21 Ch. sheath
elemento de trabajo para tubo 21 Ch. / élément de travail pour manche de 21 Ch.

243-01-02799

**URETHROTOM SCHAFT 21 CH / URETHROTOME SHEATH 21 CH
TUBOS DE URETHROTOMO 21 CH / MANCHES POUR URETHROTOME 21 CH**

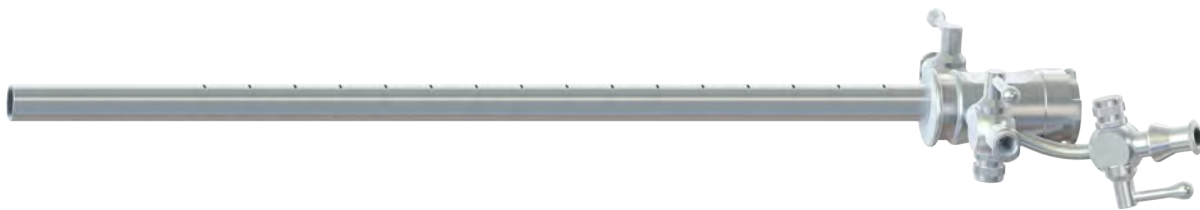

sheath with one working channel, 5 Ch.

243-16-02199

sheath with one working channel, 5 Ch., incl. obturator 243-17-02199

243-16-2199-00

OBTURATOR / OBTURATOR / OBTURADOR / OBTURATEUR



für Schaft / for sheath / para tubo / pour manche 243-16-02199

243-17-02199

TELESCOPE BRIDGE, ADULT

für Schaft / for sheath / para tubo / pour manche 243-16-02199



1 x 5 Ch. Instrumentenkanal / 1 x 5 Ch. instrument channel
1 x 5 Ch. canal de instrumento / 1 x 5 Ch. canal d'instrument

243-19-00199

URETHROTOME SHEATH

für Schaft / for sheath / para tubo / pour manche 243-16-02199



Dauerspülschaft / for continuous irrigation
para irrigacion continua / pour irrigation continue

243-16-02197

URETHROTOME GUIDING TUBE

für Schaft / for sheath / para tubo / pour manche 243-16-02199



zur Einführung von Ballonkathetern / for insertion of a balloon catheter
para inserción de catéter de balón / pour insertion d'un Cathéter à ballonnet

243-16-02198

URETHROTOM MESSER / URETHROTOME KNIFES / CUCHILLO URETROTOMO / LAMES URETROTOME

für Schaft / for sheath / para tubo / pour manche 243-16-02199



Cold knife, straight

243-20-00199



Cold knife, round

243-20-00198



Cold knife, straight, with wave cut

243-20-00197

UROLOGIE ZUBEHÖR
UROLOGY ACCESSORIES
ACCESORIOS UROLOGÍA
ACCESSOIRES UROLOGIE

ELCON
240

ELCON 240

URETERO-RENSKOPE
URETERO-RENSCOPE
URETERO-RENSCOPE
URETERO-RENSCOPE

URETERO-RENSCOPE URS

AUTOCLAVE
18 min / 134°C / 273°F



BICHLER semi-rigid URS with 45° ocular

working Ø	working channel Fr.	WL mm	direction of view	
4,5 - 6,5 Ch.	1x3,3	315 mm	5°	230-25-435
4,5 - 6,5 Ch.	1x3,3	430 mm	5°	230-25-445
6,0 - 7,5 Ch.	1x4 / 2x2,4	315 mm	5°	230-25-635
6,0 - 7,5 Ch.	1x4 / 2x2,4	315 mm	12°	230-25-631
6,0 - 7,5 Ch.	1x4 / 2x2,4	430 mm	5°	230-25-645
6,0 - 7,5 Ch.	1x4 / 2x2,4	430 mm	12°	230-25-641
8,0 - 9,8 Ch.	1x5 / 2x3	315 mm	12°	230-25-831
8,0 - 9,8 Ch.	1x5 / 2x3	430 mm	12°	230-25-841
8,5 - 11,5 Ch.	1x6 / 2x4	315 mm	12°	230-25-931
8,5 - 11,5 Ch.	1x6 / 2x4	430 mm	12°	230-25-941

MARBERGER semi-rigid URS with 45° ocular

working Ø	working channel Fr.	WL mm	direction of view	
4,5 - 6,5 Ch.	1x3,3	315 mm	5°	230-26-435
4,5 - 6,5 Ch.	1x3,3	430 mm	5°	230-26-445
6,0 - 7,5 Ch.	1x4 / 2x2,4	315 mm	5°	230-26-635
6,0 - 7,5 Ch.	1x4 / 2x2,4	315 mm	12°	230-26-631
6,0 - 7,5 Ch.	1x4 / 2x2,4	430 mm	5°	230-26-645
6,0 - 7,5 Ch.	1x4 / 2x2,4	430 mm	12°	230-26-641
8,0 - 9,8 Ch.	1x5 / 2x3	315 mm	12°	230-26-831
8,0 - 9,8 Ch.	1x5 / 2x3	430 mm	12°	230-26-841
8,5 - 11,5 Ch.	1x6 / 2x4	315 mm	12°	230-26-931
8,5 - 11,5 Ch.	1x6 / 2x4	430 mm	12°	230-26-941

WIRE BASKET



size mm 650 x 150 x 70

561-0420-70

FLEXIBLE INSTRUMENTS

without Luer-Lock connection

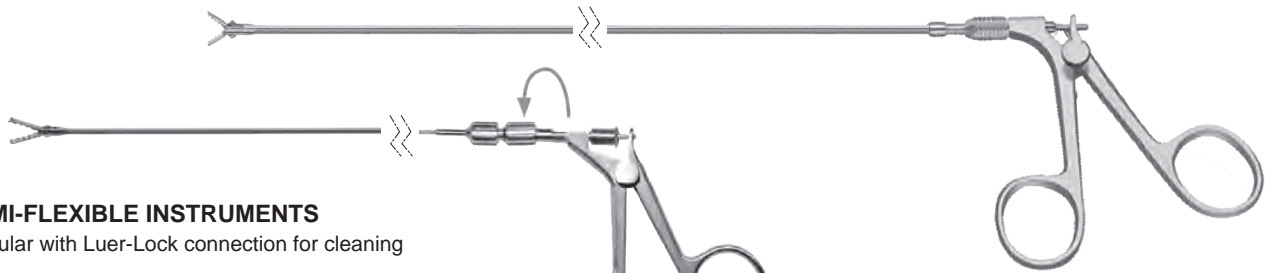

SEMI-FLEXIBLE INSTRUMENTS

modular with Luer-Lock connection for cleaning



LENGTH 600 MM		Ch.	Ø mm	flexible	semi-flexible
	Biopsie, doppelbeweglich	3	1,0	245-5063	245-7063
	biopsy, double action		1,2	245-5064	245-7064
	biopsia, doble acción	5	1,6	245-5065	245-7065
	biopsie, action double				
	Biopsie, gezahnt, doppelbeweglich	5	1,6	245-5365	245-7365
	biopsy, toothed, double action				
	biopsia, dentada, doble accion				
	biopsie, dentelée; action double				
	Alligator, Fasszange, doppelbeweglich	3	1,0	245-5163	245-7163
	Alligator, grasping forceps, double action		1,2	245-5164	245-7164
	Alligator, pinza de aprehension, doble accion	5	1,6	245-5165	245-7165
	Alligator, pince à préhension, action double				
	Schere, einzelbeweglich, stumpf	3	1,0	245-5263	245-7263
	scissors, single action, blunt		1,3	245-5264	245-7264
	tijera, simple accion, roma	5	1,6	245-5265	245-7265
	ciseaux, action simple, mousse				
	Fasszange, Steinstraße	5	1,2	245-5664	245-7664
	grasping forceps for stone street		1,6	245-5665	245-7665
	pinza de aprehension, acumulacion de calculos				
	pince de prehension, amas de calculs				
	Fasszange, Steine und Fragmente	5	1,2	245-5764	245-7764
	grasping forceps, stone fragments		1,6	245-5765	245-7765
	pinza de aprehension, fragmentos calculos				
	pince de prehension, fragments calcul				
	Fasszange, Löffel, gezahnt	5	1,2	245-5964	245-7964
	forceps, cup, serrated		1,6	245-5965	245-7965
	pinza de aprehension, cuchilla, extriada				
	pince de prehension, cuillere, striede				
	Ø 1,2 = 13 teeth				
	Ø 1,6 = 6 teeth				
	Dreiarmsgreifer	3	1,0	245-5863	
	3-Prong grasper	5	1,6	245-5865	
	pinza de aprehension, 3 dientes				
	pinza de aprehension, 3 mors				
	Steinkörbchen	3	1,0	245-5463	
	stone basket	5	1,6	245-5465	
	cesta para calculos				
	panier pour calculs				



ELCON 240

NEPHROSKOP NEPHROSCOPE

NEPHROSCOPE and MINI NEPHROSCOPE

Adaption of the most popular laser and lithotripter system is possible

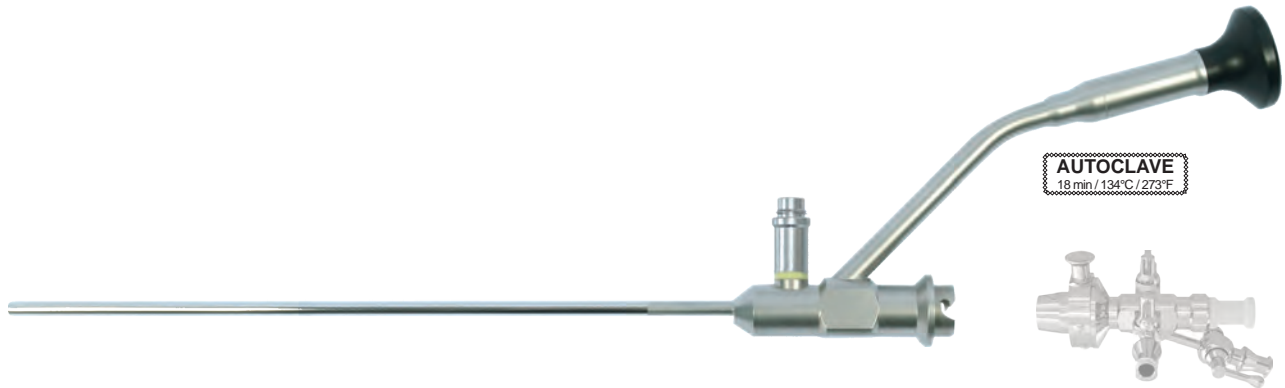

Nephrosopes	Ø mm	WL mm	Working Channel	DOV	
Mini Nephroscope	13.5 Ch.	220 mm	6 Ch.	8°	230-18-046
Nephroscope	19 Ch.	220 mm	10 Ch.	8°	230-18-045

INSTRUMENT BRIDGE

for URS and Nephrosopes



	for scopes	
Instrument Bridge	Nephrosopes 230-18-046, 230-18-045 and URS 230-24-07-310, 230-24-07-425, 230-24-06-310, 230-24-06-425	243-25-0192

NEPHROSCOPE SHEATH continuous flow 18/15 Ch.

for 13.5 Ch. Nephroscope 230-18-046

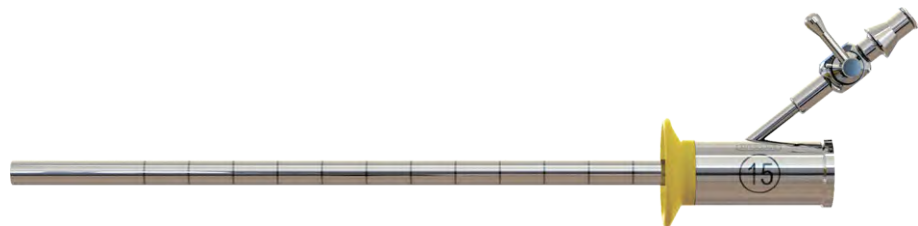

	colour code	WL mm	
	yellow	150	243-25-1599



Dilator/Obturator	for sheath	Channels Ch.	
15 Ch.	243-25-1599	centric 3, excentric 3	243-25-1597

NEPHROSCOPE SHEATH continuous flow 19,5/16,5 Ch.

for 13.5 Ch. Neproscope 230-18-046



	colour code	WL mm	
	blue	150	243-25-1699



Dilator/Obturator	for sheath	Channels Ch.	
16,5 Ch.	243-25-1699	centric 4, excentric 4	243-25-1697

NEPHROSCOPE SHEATH continuous flow 24/21 Ch.

for 19 Ch. Neproscope 230-18-045



	colour code	WL mm	
	red	150	243-25-2199



Dilator/Obturator	for sheath	Channels Ch.	
21 Ch.	243-25-2199	centric 5, excentric 5	243-25-2197

APPLICATOR FOR SEALING

incl. obturator



for sheath	
243-25-1599, 243-25-1699 and 243-25-2199	243-25-0196

TELESCOPE BOUGIE SET

9 - 24 Ch. with 6 different dilatation sleeves



	Ch.	length mm	
Bougies Set			243-25-0199
consisting of	9	248	243-25-0996
	12	238	243-25-1296
	15	228	243-25-1596
	18	218	243-25-1896
	21	208	243-25-2196
	24	198	243-25-2496

RIGID INSTRUMENTS

modular with Luer-Lock connection for cleaning

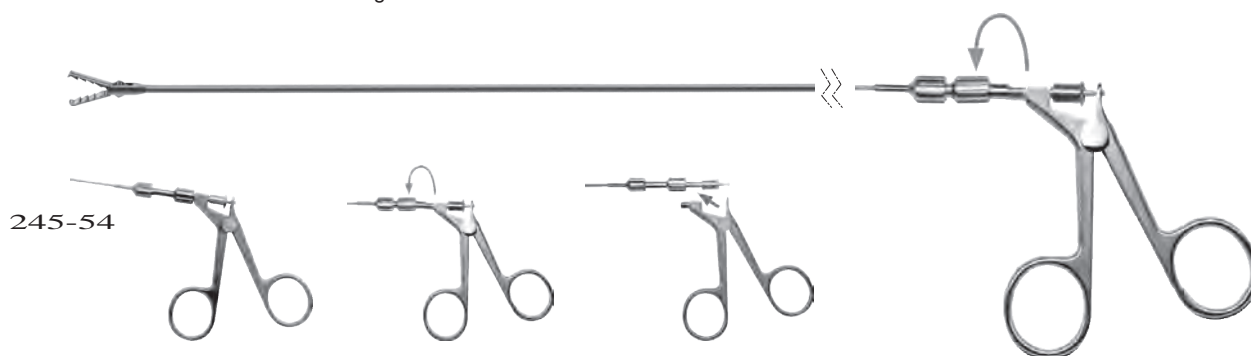

Instruments, rigid	Description	Ch.	Ø	WL	
	Alligator Fasszange, Alligator grasping forceps	5	1,6	400 mm	245-5425
	Alligator pinza de aprehension, Alligator pince à préhension	9	3,0	400 mm	245-5429
	Steinfasszange	5	1,6	400 mm	245-5415
	stone grasping forceps,	9	3,0	400 mm	245-5419
	Biopsie, biopsy	5	1,6	400 mm	245-5405
	biopsia, biopsie	9	3,0	400 mm	245-5409
	Microschere	5	1,6	400 mm	245-5435
	micro scissors	9	3,0	400 mm	245-5439
	3 - Arm Greifer, Federgriff		1,8	400 mm	245-5445
	3 - prog grasper, spring handle	9	3,0	400 mm	245-5449



Ch. / Fr.	mm	VAN BUREN 270mm, 10 3/8"	DITTEL 300mm, 9"	DITTEL 350mm, 13 3/4"	GUYON 265mm, 10 1/2"	GUYON 265mm, 10 1/2"
6	2	240-206	240-306	240-406		
8	2,6	240-208	240-308	240-408	240-608	
10	3,3	240-210	240-310	240-410	240-610	
12	4	240-212	240-312	240-412	240-612	240-524
14	4,6	240-214	240-314	240-414	240-614	240-528
16	5,3	240-216	240-316	240-416	240-616	240-534
18	6	240-218	240-318	240-418	240-618	240-538
20	6,6	240-220	240-320	240-420	240-620	240-540
22	7,3	240-222	240-322	240-422	240-622	240-544
24	8	240-224	240-324	240-424	240-624	240-548
26	8,6	240-226	240-326	240-426	240-626	240-552
28	9,3	240-228	240-328	240-428	240-628	240-556
30	10	240-230	240-330	240-430	240-630	240-560



Ch. / Fr.	mm	150mm	270mm
6	2	240-756	240-706
8	2,6	240-758	240-708
10	3,3	240-760	240-710
12	4	240-762	240-712
14	4,6	240-764	240-714

LISTER	E.G.	Ømm
240-151	0/2	1,0/2,0
240-152	0,5/3	1,3/2,5
240-153	1/4	1,5/3,0
240-154	2/5	2,0/3,5
240-155	3/6	2,5/4,0
240-156	4/7	3,0/4,5
240-157	5/8	3,5/5,0
240-158	6/9	4,0/5,5
240-159	7/10	4,5/6,0
240-160	8/11	5,0/6,5
240-161	9/12	5,5/7,0
240-162	10/13	6,0/7,5
240-163	11/14	6,5/8,0
240-164	12/15	7,0/8,5
240-165	13/16	7,5/9,0
240-166	14/17	8,0/9,5
240-167 </tr		

270mm long, bulbous tip



CLUTON	Ø FG	Ømm
240-450	6/10	2,0/3,3
240-452	8/12	2,6/4,0
240-454	10/14	3,3/4,6
240-456	12/16	4,0/5,3
240-458	14/18	4,6/6,0
240-460	16/20	5,3/6,6
240-462	18/22	6,0/7,3
240-464	20/24	6,6/8,0
240-466	22/26	7,3/8,6
240-468	24/28	8,0/9,3
240-470	26/30	8,6/10,0
240-472	28/32	9,3/10,6

270mm long



CATHETER GUIDES



240-880
400 mm, 15 3/4"
Catheter introducing
instruments



240-881
370 mm, 14 1/2"
Catheter guide (introducer)



240-883
460 mm, 18 1/8"
Catheter guide (introducer)

PENIS CLAMPS



STOCKMANN
240-900 80 mm, 3 1/4"



STRAUSS
240-902 120 mm, 4 3/4"

REINIGUNGSPISTOLE / CLEANING PISTOL
PISTOLA DE LIMPIEZA / PISTOLET DE NETTOYAGE



komplett mit 8 Adaptern, an Wasserhahn oder zentrale Druckluft anschließbar
complete with 8 adaptors, attachable to standard water tap or compressed-air
completo con 8 adaptadores conectable con grifo o suministro central de aire comprimido
complet avec 8 adaptateurs, connexion au robinet ou alimentation centrale d'air comprimé

234-00-000

Wandhalterung für Adapter / wall support for adaptors
soporte de pared para adaptadores / fixation murale pour adaptateurs

234-00-010

ANTIBESCHLAGSMITTEL / ANTI FOG SOLUTION
SOLUCION ANTI VAHO / SOLUTION ANTIBUEE

30 ml Durchstichflasche
30 ml sterile pierce bottle
30 ml esteril en botella a perforar
30 ml bouteille à percer

230-97-30



ÖL-SPRAY / OIL-SPRAY /
SPRAY DE ACEITE / HUILE-SPRAY

50 ml Pumpspray für Instrumentenreinigung und Pflege
50 ml pumpspray for instrument cleaning and care
50 ml spray de aceite (vaporizador) para limpieza y mantenimiento
50 ml vaporisateur d'huile pour nettoyage et entretien

560-051





Artikel zur Lagerung und Sterilisation finden Sie in unserem Katalog „STERILISATIONSCONTAINER“

Articles for storage and sterilisation can be found in our catalogue „STERILIZATION CONTAINER“

Vous trouverez des articles pour le stockage et la stérilisation dans notre catalogue „CONTENEUR DE STERILISATION“

Encontrará artículos para el almacenamiento y la esterilización en nuestro catálogo „CONTENEDOR DE ESTERILIZACION“

SCOPE Baskets

Siebkorb - Drahtgeflecht für URS
Wire Mesh Basket for URS
Paniers grillagé pour URS
Bandeja perforada alambrada para URS

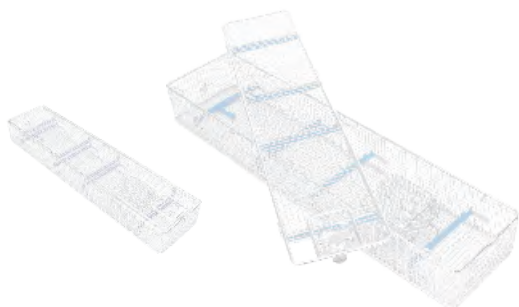

561-0420-70 640 x 150 x 77 mm

Siebkörbe - Drahtgeflecht für ein Endoskop
Wire Mesh Baskets for one endoscope
Paniers grillagés pour un endoscope
Bandeja perforada alambrada para un endoscopio



561-0400-52 290 x 80 x 52 mm
561-0402-52 460 x 80 x 52 mm
561-0404-52 670 x 80 x 52 mm



GERÄTE

UNITS

EQUIPOS

DISPOSITIFS

ELCON 240

PUMPE PUMP

UNIVERSAL / - UROLOGIEPUMPE UNIVERSAL / - UROLOGY PUMP



* shown item

Mikroprozessor gesteuerte Pumpe für variablen Einsatz in der Arthroskopie, Hysteroskopie und Urologie

Microprocessor controlled Pump for multiple usage in Arthroscopy, Hysteroscopy and Urology

akustisches und visuelles Signal für korrekten Sitz der Schläuche

acoustic and visual signals ensuring correct tubing installation

anwenderfreundlich mit gut ablesbarer digitaler Anzeige

user friendly with easy readable digital display

FLUSH Funktion für effizientes Spülen im Operationsfeld

FLUSH function for an efficient rinsing of the operating area

Optionale Fernsteuerung

Optional remote control

TECHNISCHE DATEN

Spüleleistung:	100-1000 ml/min (Urologie)
Druckbereich:	10-150 mm Hg (Urologie)
Betriebstemperatur:	+10°C bis +40°C
Betriebsfeuchtigkeit:	30% bis 70%
Dimensionen:	330 x 120 x 306 mm (BxHxD)
Gewicht:	ca. 7,5 kg
Netzspannung:	100 - 240 VAC / 50-60 Hz
CE Klassifizierung:	EN60601-1; EN60601-1-2
Sicherheitsstandard:	IP X1

TECHNICAL DATA

Flow selection:	100-1000 ml/min (Urology)
Pressure selection:	10-150 mm Hg g (Urology)
Operating temperature:	+10°C to +40°C
Operating humidity:	30% to 70%
Dimensions:	330 x 120 x 306 mm (WxHxD)
Weight:	approx. 7,5 kg
Power supply:	100 - 240 VAC / 50-60 Hz
CE classification:	EN60601-1; EN60601-1-2
Safety standard:	IP X1

Lieferumfang

Steuerungseinheit, Bedienungsanleitung, Prüfprotokoll

Delivery contains

Control Unit, user manual, test protocol

ARTIKEL NUMMER

238-45-020	Pumpe für Urologie
238-45-000*	Pumpe für variablen Einsatz in der Arthroskopie, Urologie und Hysteroskopie

SERIES

238-45-020	Fluid Pump for Urology
238-45-000*	Pump for multiple usage in Arthroscopy, Urology and Hysteroscopy

ZUBEHÖR

238-45-250	Schlauchset, Einweg, komplett
------------	-------------------------------

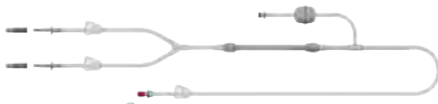

238-45-200	Schlauchset, Day use, Pumpen Part
238-45-210	Schlauchset, Einweg, Patienten Part
238-45-005	Fernsteuerung

ACCESSORIES

238-45-250	Tubing Set, single use, complete
238-45-200	Tubing Set, daily use, Pump part



238-45-210	Tubing Set, single use, Patient part
238-45-005	Remote Control

**UNIVERSAL / - BOMBA UROLOGIA
POME UNIVERSELLE / POUR UROLOGIE**



* shown item

Bomba controlada por microprocesador para uso variable en artroscopia, histeroscopia y la urología

señal acústica y visual para un correcto montaje de los tubos

utilisacion facil con pantalla digital facil de leer

funcion FLUSH para el lavado eficiente en el campo quirúrgico

Opcional control remoto

DATAS TECHNICAS

Selección de flujo:	100-1000 ml/min (Urologia)
Selección de presión:	10-150 mm Hg (Urologia)
temperatura operativa:	+10°C bis +40°C
humedad operativa:	30% bis 70%
Dimensiones:	330 x 120 x 306 mm (BxHxD)
Peso:	ca. 7,5 kg
Alimentación:	100 - 240 VAC / 50-60 Hz
CE clasificación:	EN60601-1; EN60601-1-2
Estándar de seguridad:	IP X1

Volumen de entrega

Unidad de control, manual de usuario, reporte de revisión

NUMERO DE ARTICULO

238-45-020	Bomba para Urologia
238-45-000*	Bomba para uso variable en artroscopia, urologia y histeroscopia

ACCESORIOS

238-45-250	Set de tubo, disponible, completo
238-45-200	Set de tubo, utilizacion diaria, parte de bomba
238-45-210	Set de tubo, disponible, parte de paciente



238-45-005 Control remoto

Pompe contrôlée par microprocesseur pour utilisation variable dans l'arthroscopie, hystérocopie et urologie

signal acoustique et visuel assure raccordement correcte des tuyaux

utilisation simple avec affichage numérique facile à lire

fonction FLUSH pour rinçage efficace de la zone d'opération

Contrôle à distance en option

DONNEES TECHNIQUES

Sélection flux :	100-1000 ml/min (Urologie)
Sélection pression :	10-150 mm Hg g (Urologie)
Température opérationnelle :	+10°C to +40°C
Humidité opérationnelle :	30% à 70%
Dimensions:	330 x 120 x 306 mm (WxHxD)
Poids :	env. 7,5 kg
Alimentation :	100 - 240 VAC / 50-60 Hz
Classification EC :	EN60601-1; EN60601-1-2
Standard sécurité :	IP X1

Contenu de livraison

Unité contrôle, mode d'emploi, rapport d'essai

NUMERO D'ARTICLE

238-45-020	Pompe pour Urologie
238-45-000*	Pompe pour utilisation variable pour arthroscopie, urologie, hystérocopie

ACCESSORIES

238-45-250	Set de tuyaux, usage unique, complet
238-45-200	Set de tuyaux, usage journalier, pompe
238-45-210	Set de tuyaux, usage unique, patient
238-45-005	Contrôle à distance

ELCON 240

LICHTQUELLE
LIGHT SOURCE

LED LICHTQUELLE
LED LIGHT SOURCE



50 W

geringe Lautstärke und Wärmeentwicklung

Tageslichtqualität

wasserbeständiges Bedienelement

low noise, low heat conduction

pure daylight quality

waterproof touch control panel

TECHNISCHE DATEN

Lampen	· Tageslichtqualität
Lichtleiteranschluss	· Storz
System	· Netzspannung: 100/240 VAC, 50-60 Hz · Sicherungen: 2x T3, 15A
Control	· manuell
Standard	· Schutzklasse: I · Anwendungsteil: Type BF · IEC 60601-1-2
Maße	· (BxHxT): 295 x 128 x 278 mm · Gewicht: 3,8 kg
Lieferumfang	· Lichtquelle, Netzkabel, Bedienungsanleitung

TECHNICAL DATA

Lamps	· daylight quality
Light guide adapter	· Storz
System	· power supply: 100/240 VAC, 50-60 Hz · Sicherungen: 2x T3, 15A
Control	· manual
Standard	· protection class: I · application part: Type BF · IEC 60601-1-2
Dimensions	· (WxHxD): 295 x 128 x 278 mm · Weight: 3,8 kg
Delivery contains	· light source, mains cable, user manual

ARTIKEL NUMMER

Lichtquelle, Standard - ELCON / Storz Adapter
238-15-050 (vergleichbar 50 W)

SERIES

Light source, standard - ELCON / Storz adapter
238-15-050 (comparable 50 W)

FUENTE DE LUZ LED
SOURCE DE LUMIERE DEL



50 W

generación de volumen y calor baja
calidad luz del día
unidad de control impermeable

dégagement de son et chaleur faible
qualité lumière du jour
commande par effleurement imperméable

DATOS TECNICOS

Lámparas · calidad luz del día
Adaptador de guía de luz · Storz
Sistema · alimentación: 100/240 VAC, 50-60 Hz
· fusibles: 2x T3, 15A
Control · manual
Estándar · clase de protección: I
· pieza de aplicación: tipo BF
· IEC 60601-1-2
Dimensiones · (AxAxP)): 295 x 128 x 278 mm
· peso: 3,8 kg
Volumen de entrega · fuente de luz, cable de red, cable BNC

DONNEES TECHNIQUES

Lampes · qualité lumière du jour
Adaptateur guide de lumière · Storz
Système · alimentation: 100/240 VAC, 50-60 Hz
· fusibles: 2x T3, 15A
Contrôle · manuelle
Standard · classe de protection: I
· pièce d'application: type BF
· IEC 60601-1-2
Dimensions · (LxHxP): 295 x 128 x 278 mm
· poids: 3,8 kg
Livraison contient · source de lumière, câble d'alimentation

NUMERO DE ARTICULO

Fuente de luz, estándar - adaptador ELCON / Storz
238-15-050 (comparable 50 W)

NUMERO D'ARTICLE

Source de lumière, standard - adaptateur ELCON / Storz
238-15-050 (comparable 50 W)

ELCON 240

LICHTQUELLE
LIGHT SOURCE

LED LICHTQUELLE
LED LIGHT SOURCE



Optional turret adapter
Storz, Wolf, Olympus, ACMI (A)



geringe Lautstärke und Wärmeentwicklung
manuelle & automatische Intensitätskontrolle
Tageslichtqualität
wasserbeständiges Bedienelement

low noise, low heat conduction
manual & automatic electronic light control
pure daylight quality
waterproof touch control panel

TECHNISCHE DATEN

Lampen	<ul style="list-style-type: none">· Tageslichtqualität, 6500 K· Lebensdauer: >20.000 hr
Lichtleiteranschluss System	<ul style="list-style-type: none">· Storz, Wolf· Netzspannung: 100/240 VAC, 50-60 Hz· Sicherungen: 2 Stück 5 x 20 mm, delay 6,3 AT· Leistungsaufnahme: 180/250/300 W
Control Video In (opt.) Standard	<ul style="list-style-type: none">· automatisch und manuell· 1x Video· Schutzklasse: I · Anwendungsteil: Type BF· IEC 60601-1-2· Klassifizierung nach MDD 93/42/EEC: I
Maße	<ul style="list-style-type: none">· (BxHxD): 360 x 124 x 335 mm· Gewicht: 5 kg
Lieferumfang	<ul style="list-style-type: none">· Lichtquelle, Netzkabel, Bedienungsanleitung· BNC Kabel (optional)

TECHNICAL DATA

Lamps	<ul style="list-style-type: none">· daylight quality, 6500 K· lifetime: >20.000 hr
Light guide adapter System	<ul style="list-style-type: none">· Storz, Wolf· power supply: 100/240 VAC, 50-60 Hz· fuses: 2 Fine fuses, 5 x 20 mm, delay 6,3 AT· power consumption: 180/250/300 W
Control Video In (opt.) Standard	<ul style="list-style-type: none">· automatic and manual· 1x Video· protection class: I · application part: Type BF· IEC 60601-1-2· classification acc. MDD 93/42/EEC: I
Dimensions	<ul style="list-style-type: none">· (WxHxD): 360x124x335 mm· Weight: 5 kg
Delivery contains	<ul style="list-style-type: none">· light source, mains cable, user manual,· BNC cable (optional)

ARTIKEL NUMMER

Lichtquelle, Standard - ELCON / Storz Adapter

238-15-250 (250 W / 6500K / CRI 70)

238-15-301 (300 W / 6500K / CRI 90)

Lichtquelle, Turret adapter

238-15-301-A (300 W / 6500K / CRI 90)

SERIES

Light source, standard - ELCON / Storz adapter

238-15-250 (250 W / 6500K / CRI 70)

238-15-301 (300 W / 6500K / CRI 90)

Light source, Turret adapter

238-15-301-A (300 W / 6500K / CRI 90)

FUENTE DE LUZ LED
SOURCE DE LUMIERE DEL



Optional turret adapter
Storz, Wolf, Olympus, ACMI (A)



250 W

300 W

generación de volumen y calor baja
control de luminosidad manual y automático
calidad luz del día
unidad de control impermeable

dégagement de son et chaleur faible
contrôle d'intensité lumière manuel et automatique
qualité lumière du jour
commande par effleurement imperméable

DATOS TECNICOS

Lámparas	· calidad luz del día, 6500 K · tiempo de vida: >20.000 hr
Adaptador de guía de luz	· Storz, Wolf
Sistema	· alimentación: 100/240 VAC, 50-60 Hz · fusibles: 2x, 5 x 20 mm, temporización 6,3 AT · consumo: 250/300 W}
Control	· automático y manual
Video In (opción)	· 1x vídeo
Estándar	· clase de protección: I · pieza de aplicación: tipo BF · IEC 60601-1-2 · clasificación según MDD 93/42/EEC: I
Dimensiones	· (AxHxP): 360x124x335 mm · peso: 5 kg
Volumen de entrega	· fuente de luz, cable de red, cable BNC (opcional), manual de instrucciones

DONNEES TECHNIQUES

Lampes	· qualité lumière du jour, 6500 K · durée de vie: >20.000 hr
Adaptateur guide de lumière	· Storz, Wolf
Système	· alimentation: 100/240 VAC, 50-60 Hz · fusibles: 2x, 5 x 20 mm, temporisation 6,3 AT · consommation: 250/300 W}
Contrôle	· automatique et manuelle
Entrée vidéo (option)	· 1x vidéo
Standard	· classe de protection: I · pièce d'application: type BF · IEC 60601-1-2 · classification selon MDD 93/42/EEC: I
Dimensions	· (LxHxP): 360 x 124 x 335 mm · poids: 5 kg
Livraison contient	· source de lumière, câble d'alimentation, câble BNC (optionnel), mode d'emploi

NUMERO DE ARTICULO

Fuente de luz, estándar - adaptador ELCON / Storz

238-15-250 (250 W / 6500K / CRI 70)

238-15-301 (300 W / 6500K / CRI 90)

Fuente de luz, Turret adapter

238-15-301-A (300 W / 6500K / CRI 90)

NUMERO D'ARTICLE

Source de lumière, standard - adaptateur ELCON / Storz

238-15-250 (250 W / 6500K / CRI 70)

238-15-301 (300 W / 6500K / CRI 90)

Source de lumière, Turret adapter

238-15-301-A (300 W / 6500K / CRI 90)

ELCON 240

KAMERA
CAMERA

HD VIDEO KAMERA
HD VIDEO CAMERA



1CHIP eco HD

1CHIP eco HD +
capture system

Full HD Auflösung / digitaler Zoom 2,5 X / High speed shutter / mehrsprachiges „On-Screen“ Menü / 3 Benutzereinstellungen, speicherbar / „Freeze function“

„Boost Funktion“ für die Steigerung der Helligkeit im Falle geringer Lichtintensität

Full HD resolution / digital Zoom 2,5 X / high speed shutter / multilingual on-screen menu / 3 user settings storable / „Freeze function“

„Boost Function“ to increase the brightness in case of low illumination

TECHNICAL DATA

Camera head	· aspect ratio: 16:9 · image sensor: 1/3" MOS · immersible (using the attached cap)
System	· power supply: 100/240 VAC, 50-60 Hz · power consumption: 25 W · fuses: 2 fine fuses, 5 x 20 mm, delay acting 3,5 AH (I=1500 A) · image resolution: full HD 1920 x 1080 · TV resolution: > 1000 lines · sensitivity: < 3 lux (1/1.4) · SN 54 db · white balance automatically, with data hold · shutter speed: 1/50 (1/60) to 1/100.000 sec
Video out terminal	· 1x HDMI
Other Connections	· 1 x USB (A) (USB-keyboard) / 1 x Remote IN (footswitch) / 1 x Remote OUT (video printer, video recorder,...) / 1 x RJ45 (Service)
Standard	· protection class: I / safety class: BF / IP code 20 / IEC 60601-1-2, classification acc. to MDD 93/42/EEC: I
Dimensions	· (WxHxD): 359 x 106 x 335 mm · weight: 4,7 kg
Delivery contains	· CCU, camera head with 3,05m cable, mains cable, HDMI - DVI cable, HDMI cable, user manual

SERIES

Basic settings	238-22-110	Camera head Weight: 150 g Size: d= 36 mm; l= 65 mm
Basic settings incl. internal HD video and image capture & archiving system on USB. Recording format 1080p/60	238-22-110-C	

TV-Adapter (C-mount) on page URO 50 must be ordered separately



OPTIONS

Remote camera head with 6 functions	238-22-110-R		Remote Camera head Weight: 180 g Size: d= 38 mm; l= 79 mm
Keyboard (medical)	238-2X-XXX-T		

CAMARA DE VIDEO HD
CAMERA VIDEO HD

Resolución Full AD / zoom digital 2,5 X / obturador de alta velocidad/ menú de multilingue „On-Screen“ / 3 configuraciones de usuario, memorizable / función „Freeze“

„Generador de Caracteres “ para presentar informaciones en los monitores con el teclado PS2 estándar

„Boost Function“ para aumentar la luminosidad en caso de baja intensidad de luz.

résolution „Full HD“ / zoom digital 2,5 X / obturateur grande vitesse / menu d'écran multilingue / 3 paramètres d'utilisateur mémorisables / „Freeze function“

„Générateur de caractères“ crée des informations sur l'écran via clavier standard PS2

„Boost Function“ pour augmenter la clarté en cas d'intensité de lumière faible

DATOS TECNICOS / DONNEES TECHNIQUES

Cabeza de cámara / Tête caméra	· relación de aspecto / relation aspect: 16:9 · sensor de imagen / capteur image: 1/3" MOS sumergible / à immersion (a utilizar la tapa adjunto / à utiliser le bouchon joint)
Sistema / Système	· alimentación / alimentation: 100/240 VAC, 50-60 Hz · consumo de energía / consommation: 25 W · fusibles / fusibles: 2 fusibles fino, 5 x 20 mm, acción retardada / action retardée 3,5 AH (I=1500 A) · resolución del imagen: full HD 1920 x 1080 · TV resolución: > 1000 lines · sensibilidad / sensibilité: < 3 lux (1/1.4) · SN 54 db · balance de blancos automáticamente con retención de datos / balance des blancs automatique avec „data-hold“ · velocidad de obturación / vitesse obturateur: 1/50 (1/60) to/à 1/100.000 sec
Salida de vídeo / Sortie vidéo	· 1x HDMI
Conexión / Connexions	· 1 x USB (A) (USB-keyboard) / 1 x Remote IN (footswitch) / 1 x Remote OUT (video printer, video recorder,...) / 1 x RJ45 (Service)
Estándar / Standard	· protección clase / classe de protection: I · parte de aplicación / pièce d'application : Tipo BF · IEC 60601-1-2 · clasificación según / classification d'après MDD 93/42/EEC: I
Dimensiones / Dimensions	· (LxHxP): 359 x 106 x 335 mm · peso / poids: 4,7 kg
Volumen de entrega /	· CCU, cabezal de la cámara con cable de 3,05m, cable de red, HDMI cable, manual de instrucciones CCU, tête caméra avec câble de 3,05m, câble d'alimentation, câble HDMI, mode d'emploi

NUMERO DE ARTICULO / NUMERO D'ARTICLE

Configuración básica / Equipement de base **238-22-110**

Configuración básica incl. vídeo HD y captura de imágenes interna & sistema de archivo en USB, formato de grabación 1080p/60
Equipement de base incl. saisie interne de vidéos HD et d'images & système d'archivage sur USB, format d'enregistrement 1080p/60.

238-22-110-CCabeza de cámara /
Tête caméra

Adaptador TV (C-mount) en pagina URO 50 debe pedir por separado
Adaptateur TV (C-mount) de page URO 50 doit être commandé séparément

OPCIONES / OPTIONS

Cabeza de cámara con 6 funciones
Tête caméra à télécommande avec 6 fonctions **238-20-130-R**

Opcional cabeza de cámara /
Tête caméra en option

Teclado (médico) / Clavier (médical) **238-2X-XXX-T**

TEAC HD recording system on HDD 500GG or USB **04-UR-4MD**



Sistema de captura -pida el folleto independiente /
Veuillez demander brochure séparée pour système de saisie

ELCON 240

KAMERA
CAMERA

HD VIDEO KAMERA
HD VIDEO CAMERA



1CHIP HD

1CHIP HD +
capture system

Full HD Auflösung / digitaler Zoom 2,5 X / High speed shutter / mehrsprachiges „On-Screen“ Menü / 3 Benutzereinstellungen, speicherbar / „Freeze function“ / Kamerakopf mit 6 Speichermöglichkeiten

„Boost Funktion“ für die Steigerung der Helligkeit im Falle geringer Lichtintensität

Full HD resolution / digital Zoom 2,5 X / high speed shutter / multilingual on-screen menu / 3 user settings storable / „Freeze function“ / remote camera head with 6 storage possibilities

„Boost Function“ to increase the brightness in case of low illumination

TECHNICAL DATA

Camera head	· aspect ratio: 16:9 · image sensor: 1/3" MOS · immersible (using the attached cap)
System	· power supply: 100/240 VAC, 50-60 Hz · power consumption: 20 W · fuses: 2 fine fuses, 5 x 20 mm, delay acting 3,5 AH (I=1500 A) · image resolution: full HD 1920 x 1080 · TV resolution: > 1000 lines · sensitivity: < 3 lux (1/1.4) · SN 54 db · white balance automatically, with data hold · shutter speed: 1/50 (1/60) to 1/100.000 sec
Video out terminal	· 1x HDMI / DVI · 1x Y-Pb-Pr · 1x video (PAL / NTSC) · 1x S-video (PAL / NTSC) · 2x HD SDI (optional)
Other Connections	· 1 x USB (A) (USB-keyboard) / 1 x Remote IN (footswitch) / 1 x Remote OUT (video printer, video recorder,...) / 1 x RJ45 (Service)
Standard	· protection class: I / safety class: BF / IP code 20 / IEC 60601-1-2, classification acc. to MDD 93/42/EEC: I
Dimensions	· (WxHxD): 355 x 103 x 253 mm · weight: 4,5 kg
Delivery contains	· CCU, camera head with 3,05m cable, mains cable, Y/C cable, BNC cable, HDMI - DVI cable, HDMI cable, user manual

SERIES

Basic settings	238-22-100
Basic settings incl. internal HD video and image capture & archiving system on USB. Recording format 1080p/60	238-22-100-C

Camera head
Weight: 105 g
Size: d= 34 mm; l= 73 mm

TV-Adapter (C-mount) on page URO 50 must be ordered separately



OPTIONS

Keyboard (medical)	238-2X-XXX-T
TEAC HD recording system on HDD 500GG or USB	04-UR-4MD

capture system
please ask for separate leaflet



CAMARA DE VIDEO HD
CAMERA VIDEO HD

Resolución Full AD / zoom digital 2,5 X / obturador de alta velocidad/ menú de multilingue „On-Screen“ / 3 configuraciones de usuario, memorizable / función „Freeze“ / cabeza de cámara con 6 botones de memoria

„Generador de Caracteres “ para presentar informaciones en los monitores con el teclado PS2 estándar

„Boost Function“ para aumentar la luminosidad en caso de baja intensidad de luz.

résolution „Full HD“ / zoom digital 2,5 X / obturateur grande vitesse / menu d'écran multilingue / 3 paramètres d'utilisateur mémorisables / „Freeze function“ / tête caméra à télécommande avec 6 possibilités de mémorisation

„Générateur de caractères“ crée des informations sur l'écran via clavier standard PS2

„Boost Function“ pour augmenter la clarté en cas d'intensité de lumière faible

DATOS TECNICOS / DONNEES TECHNIQUES

Cabeza de cámara / Tête caméra	· relación de aspecto / relation aspect: 16:9 · sensor de imagen / capteur image: 1/3" MOS sumergible / à immersion (a utilizar la tapa adjunto / à utiliser le bouchon joint)
Sistema / Système	· alimentación / alimentation: 100/240 VAC, 50-60 Hz · consumo de energía / consommation: 20 W · fusibles / fusibles: 2 fusibles fino, 5 x 20 mm, acción retardada / action retardée 3,5 AH (I=1500 A) · resolución del imagen: full HD 1920 x 1080 · TV resolución: > 1000 lines · sensibilidad / sensibilité: < 3 lux (1/1.4) · SN 54 db · balance de blancos automáticamente con retención de datos / balance des blancs automatique avec „data-hold“ · velocidad de obturación / vitesse obturateur: 1/50 (1/60) to/à 1/100.000 sec
Salida de vídeo / Sortie vidéo	· 1x HDMI / DVI · 1x Y-Pb-Pr · 1x Video · 1x S-Video (PAL / NTSC) · 2x HD SDI (opción / option)
Conexión / Connexions	· 1 x USB (A) (USB-keyboard) / 1 x Remote IN (footswitch) / 1 x Remote OUT (video printer, video recorder,...) / 1 x RJ45 (Service)
Estándar / Standard	· protección clase / classe de protection: I · parte de aplicación / pièce d'application : Tipo BF · IEC 60601-1 · clasificación según / classification d'après MDD 93/42/EEC: I
Dimensiones / Dimensions	· (LxHxP): 355 x 103 x 253 mm · peso / poids: 4,5 kg
Volumen de entrega / Livraison contient	· CCU, cabezal de la cámara con cable de 3,05m, cable de red, cable Y / C, cable BNC, HDMI - DVI cable, HDMI cable, RGB cable, manual de instrucciones / CCU, tête caméra avec câble de 3,05m, câble d'alimentation, câble Y/C, câble BNC, câble HDMI - DVI, câble HDMI, mode d'emploi

NUMERO DE ARTICULO / NUMERO D'ARTICLE

Configuración básica / Equipement de base

238-22-100

Configuración básica incl. vídeo HD y captura de imágenes interna & sistema de archivo en USB, formato de grabación 1080p/60
Equipement de base incl. saisie interne de vidéos HD et d'images & système d'archivage sur USB, format d'enregistrement 1080p/60.

238-22-100-C

Cabeza de cámara /
Tête caméra
Peso / Poids: 105 g
Dimensión / Dimension:
d= 34 mm; l= 73 mm

Adaptador TV (C-mount) en pagina URO 50 debe pedir por separado
Adaptateur TV (C-mount) de page URO 50 doit être commandé séparément

OPCIONES / OPTIONS

Teclado (médico) / Clavier (médical)

238-2X-XXX-T

TEAC HD recording system on HDD 500GG or USB

04-UR-4MD

Sistema de captura -pida el folleto independiente /
Veuillez demander brochure séparée pour système de saisie



ELCON 240

KAMERA
CAMERA

HD VIDEO KAMERA
HD VIDEO CAMERA



3CHIP HD

3CHIP HD +
capture system

Full HD Auflösung / digitaler Zoom 2,5 X / High speed shutter / mehrsprachiges „On-Screen“ Menü / 3 Benutzereinstellungen, speicherbar / „Freeze function“ / Kamerakopf mit 6 Speichermöglichkeiten

„Boost Funktion“ für die Steigerung der Helligkeit im Falle geringer Lichtintensität

Full HD resolution / digital Zoom 2,5 X / high speed shutter / multilingual on-screen menu / 3 user settings storable / „Freeze function“ / remote camera head with 6 storage possibilities

„Boost Function“ to increase the brightness in case of low illumination

TECHNICAL DATA

Camera head	· aspect ratio: 16:9 · image sensor: 3/3" MOS · immersible (using the attached cap)
System	· power supply: 100/240 VAC, 50-60 Hz · power consumption: 20 W · fuses: 2 fine fuses, 5 x 20 mm, delay acting 3,5 AH (I=1500 A) · image resolution: full HD 1920 x 1080 · TV resolution: > 1000 lines · sensitivity: < 3 lux (1/1.4) · SN 54 db · white balance automatically, with data hold · shutter speed: 1/50 (1/60) to 1/100.000 sec
Video out terminal	· 2x HD SDI · 1x HDMI / DVI · 1x Y-Pb-Pr (component) · 1x Y/C (PAL / NTSC) · 1x CVBS (PAL / NTSC)
Other Connections	· 1 x USB (A) (USB-keyboard) / 1 x Remote IN (footswitch) / 1 x Remote OUT (video printer, video recorder,...) / 1 x RJ45 (Service)
Standard	· protection class: I / safety class: BF / IP code 20 / IEC 60601-1-2, classification acc. to MDD 93/42/EEC: I
Dimensions	· (WxHxD): 355 x 103 x 253 mm · weight: 4,5 kg
Delivery contains	· CCU, camera head with 3,25m cable, mains cable, Y/C cable, BNC cable, HDMI - DVI cable, HDMI cable, RGB cable, user manual

SERIES

Basic settings	238-22-300	Camera head Weight: 145 g Size: d= 38,5 mm; l= 81 mm
Basic settings incl. internal HD video and image capture archiving system on USB. Recording format 1080p/60	238-22-300-C	

TV-Adapter (C-mount) on page URO 50 must be ordered separately



OPTIONS

Keyboard (medical)	238-2X-XXX-T	capture system please ask for separate leaflet
TEAC HD recording system on HDD 500GG or USB	04-UR-4MD	



CAMARA DE VIDEO HD
CAMERA VIDEO HD

Resolución Full AD / zoom digital 2,5 X / obturador de alta velocidad / menú de multilingue „On-Screen“ / 3 configuraciones de usuario, memorizable / función „Freeze“ / cabeza de cámara con 6 botones de memoria

„Generador de Caracteres “ para presentar informaciones en los monitores con el teclado PS2 estándar

„Boost Function“ para aumentar la luminosidad en caso de baja intensidad de luz.

Résolution „Full HD“ / zoom digital 2,5 X / obturateur grande vitesse / menu d'écran multilingue / 3 paramètres d'utilisateur mémorisables / „Freeze function“ / tête caméra à télécommande avec 6 possibilités de mémorisation

„Générateur de caractères“ crée des informations sur l'écran via clavier standard PS2

„Boost Function“ pour augmenter la clarté en cas d'intensité de lumière faible

DATOS TECNICOS / DONNEES TECHNIQUES

Cabeza de cámara / Tête caméra Sistema / Système	<ul style="list-style-type: none"> · relación de aspecto / relation aspect: 16:9 · sensor de imagen / capteur image: 3/3" MOS · alimentación / alimentation: 100/240 VAC, 50-60 Hz · consumo de energía / consommation: 20 W · fusibles / fusibles: 2 fusibles finos, 5 x 20 mm, acción retardada / action retardée 3,5 AH (I=1500 A) · resolución imagen / résolution image: full HD 1920 x 1080 · TV resolución: > 1000 líneas · sensibilidad / sensibilité: < 3 lux (1/1.4) · SN 54 db · balance de blancos automáticamente con retención de datos / balance des blancs automatique avec „data-hold“ · velocidad de obturación / vitesse obturateur: 1/50 (1/60) to/à 1/100.000 sec
Salida de vídeo / Sortie vidéo	· 2x HD SDI · 1x HDMI / DVI · 1x Y-Pb-Pr (component) · 1x Y/C · 1x CVBS (PAL / NTSC)
Conexión / Connexions	· 1 x USB (A) (USB-keyboard) / 1 x Remote IN (footswitch) / 1 x Remote OUT (video printer, video recorder,...) / 1 x RJ45 (Service)
Estándar / Standard	<ul style="list-style-type: none"> · protección clase / classe de protection: I · parte de aplicación / pièce d'application : Tipo BF · IEC 60601-1-2 · clasificación según / classification d'après MDD 93/42/EEC: I
Dimensiones / Dimensions	· (LxPxH): 355 x 103 x 253 mm · peso / poids: 4,5 kg
Volumen de entrega / Livraison contient	· CCU, cabezal de la cámara con cable de 3,25m, cable de red, cable Y / C, cable BNC, HDMI - DVI cable, HDMI cable, manual de instrucciones / CCU, tête caméra avec câble de 3,05m, câble d'alimentation, câble Y/C, câble BNC, câble HDMI - DVI, câble HDMI, mode d'emploi

NUMERO DE ARTICULO / NUMERO D'ARTICLE

Configuración básica / Equipement de base

238-22-300

Configuración básica incl. vídeo HD y captura de imágenes interno & sistema de archivo en USB, formato de grabación 1080p/60
Equipement de base incl. saisie de vidéos HD et d'images interne & système d'archivage sur USB, format d'enregistrement 1080p/60.

238-22-300-C

Cabeza de cámara /
Tête caméra
Peso / Poids: 145 g
Dimensión / Dimension:
d= 38,5 mm; l= 81 mm

Adaptador TV (C-mount) en pagina URO 50 debe pedir por separado
Adaptateur TV (C-mount) de page URO 50 doit être commandé séparément

OPCIONES / OPTIONS

Teclado (médico) / Clavier (médical)

238-2X-XXX-T

TEAC HD recording system on HDD 500GG or USB

04-UR-4MD

Sistema de captura -pida el folleto independiente /
Veuillez demander brochure séparée pour système de saisie



ELCON 240

KAMERA
CAMERA

4K VIDEO KAMERA
4K VIDEO CAMERA



3CHIP 4K

3CHIP 4K +
capture system

4K UHD Auflösung / digitaler Zoom / mehrsprachiges „On-Screen“ Menü / 10 Benutzereinstellungen speicherbar / „Freeze function“ / Kamerakopf mit 4 Drucktasten / Bildverbesserung in Farbe und Struktur / „fog reduction“

„Boost Funktion“ für die Steigerung der Helligkeit im Falle geringer Lichtintensität

4K UHD resolution / digital Zoom / multilingual on-screen menu / 10 user settings storable / „Freeze function“ / remote camera head with 4 push buttons / Image enhancement of colour and structure / fog reduction

„Boost Function“ to increase the brightness in case of low illumination

TECHNICAL DATA

Camera head	· aspect ratio: 16:9 · image sensor: 3/3" MOS · immersible (using the attached cap)
System	· power supply: 100/240 VAC, 50-60 Hz · power consumption: 60 W · fuses: 2 x T3,15 A · image resolution: full HD 3840 x 2160 · TV resolution: > 1600 lines · SN 54 db · white balance automatically, with data hold
Video out terminal	· 1 x HDMI 4K - 1 x HDMI Full HD - 1 x SDI 45 (4 x BNC) - 1x SDI Full HD (1 x BNC)
Standard	· protection class: I / safety class: BF / IP code 20 / IEC 60601-1-2 / classification acc. to MDD 93/42/EEC: I
Dimensions	· (WxHxD): 355 x 103 x 350 mm · weight: 6,2 kg
Delivery contains	· CCU, camera head with 3,05m cable, mains cable, HDMI cable, user manual

SERIES

Basic settings	238-22-400
Basic settings incl. internal HD video and image capture archiving system on USB. Recording format 1080p/60	238-22-400-C

Camera head
Weight: 200 g
Size: d= 43 mm; l= 86 mm

TV-Adapter (C-mount) on page URO 50 must be ordered separately



OPTIONS

Keyboard (medical)	238-2X-XXX-T
TEAC HD recording system on HDD 500GG or USB	04-UR-4MD

capture system
please ask for separate leaflet



CAMARA DE VIDEO 4K
CAMERA VIDEO 4K

Resolución 4K UHD / zoom digital / menú de multilingüe „On-Screen“ / 10 configuraciones de usuario, memorizable / función „Freeze“ / cabeza de cámara con 4 pulsador / „fog reduction“

„Generador de Caracteres “ para presentar informaciones en los monitores con el teclado PS2 estándar

„Boost Function“ para aumentar la luminosidad en caso de baja intensidad de luz.

Résolution „4K UHD“ / zoom digital / menu d'écran multilingue / 10 paramètres d'utilisateur mémorisables / „Freeze fonction“ / tête caméra à télécommande avec 4 bouton poussoir / „fog reduction“

„Générateur de caractères“ crée des informations sur l'écran via clavier standard PS2

„Boost Function“ pour augmenter la clarté en cas d'intensité de lumière faible

DATOS TECNICOS / DONNEES TECHNIQUES

Cabeza de cámara / Tête caméra	· relación de aspecto / relation aspect: 16:9 · sensor de imagen / capteur image: 3/3" MOS
Sistema / Système	· alimentación / alimentation: 100/240 VAC, 50-60 Hz · consumo de energía / consommation: 60 W
	· fusibles / fusibles: 2 x T3,15 A
	· resolución imagen / résolution image: full HD 3840 x 2160 · TV resolución: > 1600 líneas
	· sensibilidad / sensibilité: SN 54 db
	· balance de blancos automáticamente con retención de datos / balance des blancs automatique avec „data-hold“
Salida de vídeo / Sortie vidéo	· 1 x HDMI 4K - 1 x HDMI Full HD - 1 x SDI 45 (4 x BNC) - 1x SDI full HD (1 x BNC)
Estándar / Standard	· protección clase / classe de protection: I
	· parte de aplicación / pièce d'application : Tipo BF · IEC 60601-1-2
	· clasificación según / classification d'après MDD 93/42/EEC: I
Dimensiones / Dimensions	· (LxPxH): 355 x 103 x 350 mm · peso / poids: 6,2 kg
Volumen de entrega /	· CCU, cabezal de la cámara con cable de 3,05m, HDMI cable, manual de instrucciones CCU, tête caméra avec câble de 4m, câble HDMI, mode d'emploi

NUMERO DE ARTICULO / NUMERO D'ARTICLE

Configuración básica / Equipement de base

238-22-400

Configuración básica incl. vídeo HD y captura de imágenes interno & sistema de archivo en USB, formato de grabación 1080p/60
Equipement de base incl. saisie de vidéos HD et d'images interne & système d'archivage sur USB, format d'enregistrement 1080p/60.

238-22-400-C

Cabeza de cámara /
Tête caméra
Peso / Poids: 200 g
Dimensión / Dimension:
d= 43 mm; l= 86 mm

Adaptador TV (C-mount) en pagina URO 50 debe pedir por separado
Adaptateur TV (C-mount) de page URO 50 doit être commandé séparément

OPCIONES / OPTIONS

Teclado (médico) / Clavier (médical)

238-2X-XXX-T

TEAC HD recording system on HDD 500GG or USB

04-UR-4MD

Sistema de captura -pida el folleto independiente /
Veuillez demander brochure séparée pour système de saisie



ELCON 240

TV-ADAPTER
TV-ADAPTER
ADAPTADOR TV
ADAPTATEUR TV

**HD
4K**

HIGH END TV-ADAPTER stainless steel
MANUAL C-mount adapter / adaptador / adaptateur

rotation



Focus

14 mm	04-ILO-00001
18 mm	04-ILO-00002
22 mm	04-ILO-00003
25 mm	04-ILO-00004
28 mm	04-ILO-00005

rotation



ZOOM

Focus

15 - 30 mm	04-ILO-00006
------------	--------------

**no
HD**

TV-ADAPTER / ADAPTADOR / ADAPTATEUR
MANUAL C-mount adapter / adaptador / adaptateur

Focus

15 mm	238-30-015
21 mm	238-30-021
28 mm	238-30-028
35 mm	238-30-035



ZOOM

Focus

15 - 25 mm	238-30-152
15 - 35 mm	238-30-153



**no
HD**

TV-ADAPTER - BEAMSPLITTER
MANUAL C-mount adapter / adaptador / adaptateur

Focus

18 mm	238-31-018
25 mm	238-31-025
30 mm	238-31-030



LICHTLEITKABEL, hitzebeständig bis **500°C**, verschiedene Farben auf Anfrage erhältlich

FIBEROPTIC CABLES, heat resistant up to **500°**, various colours available on request

CABLES DE FIBRAS OPTICAS, resistente al calor hasta **500°C**, varios colores disponibles bajo petición

CABLES A FIBRES OPTIQUES, résistant à la chaleur jusqu'à **500°C**, diverses couleurs disponibles sur demande



Adapter vor Sterilisation entfernen
remove adaptor before sterilization
retire el adaptador antes de la esterilizacion
enlevez l'adaptateur avant stérilisation

TYPE I

Kabel hochtemperaturverklebt mit Standard-Adaptern
Cable high temperature agglutinated with standard adaptors
Cable aglutinado a altas temperaturas con adaptadores estandar
Câble agglutiné à haute température avec adaptateurs standard

TYPE II

Kabel, Standard, mit Quarz-Adaptern
Cable, standard, with quartz adaptors
Cable, estándar, con adaptadores de cuarzo
Câble, standard, avec adaptateurs quartz

ELCON / STORZ / AESCULAP



Ø / mm	length / mm	TYPE I	TYPE II
3,5	1800	238-80-180E	238-85-180E
3,5	2300	238-80-230E	238-85-230E
3,5	3000	238-80-300E	238-85-300E
4,8	1800	238-81-180E	238-86-180E
4,8	2300	238-81-230E	238-86-230E
4,8	3000	238-81-300E	238-86-300E

OLYMPUS



3,5	1800	238-80-180O	238-85-180O
3,5	2300	238-80-230O	238-85-230O
3,5	3000	238-80-300O	238-85-300O
4,8	1800	238-81-180O	238-86-180O
4,8	2300	238-81-230O	238-86-230O
4,8	3000	238-81-300O	238-86-300O

WOLF / MEDICON / COMEG / HSW



3,5	1800	238-80-180W	238-85-180W
3,5	2300	238-80-230W	238-85-230W
3,5	3000	238-80-300W	238-85-300W
4,8	1800	238-81-180W	238-86-180W
4,8	2300	238-81-230W	238-86-230W
4,8	3000	238-81-300W	238-86-300W

ACMI / CODMAN / BRITISH STANDARD



3,5	1800	238-80-180A	238-85-180A
3,5	2300	238-80-230A	238-85-230A
3,5	3000	238-80-300A	238-85-300A
4,8	1800	238-81-180A	238-86-180A
4,8	2300	238-81-230A	238-86-230A
4,8	3000	238-81-300A	238-86-300A

MEDIZINISCHE MONITORE HD & 4K / MEDICAL GRADE MONITORS HD & 4K
MONITORES MEDICAL HD & 4K / MONITEURS DEGRE MEDICAL HD & 4K

SONY / FSN



Monitore mit Fuß, with stand, con pie, avec support	Monitor
SONY-21	21" HD

Monitore ohne Fuß, w/o stand, sin pie, sans support	Monitor
SONY-24	24" HD
SONY-27	27" HD
SONY-31	31" 4K
SONY-32	32" HD
SONY-55	55" 4K

Monitore ohne Fuß, w/o stand, sin pie, sans support	Monitor
FSN-21	21" HD
FSN-24	24" HD
FSN-27	27" HD
FSN-27/4	27" 4K
FSN-31/4	31" 4K
FSN-32	32" HD



STAND

Fuß für SONY / FSN Monitore / Stand for SONY / FSN monitors /
Pie para monitores SONY / FSN / Support pour moniteurs SONY / FSN

238-72-200

Gerätewagen für Monitor, 132cm hoch, antistatisch mit variabler VESA 100-400 Halterung
Equipment cart for monitor, 132cm high, antistatic with variable VESA 100-400 bracket
Carro de equipo para monitor, 132 cm de altura, antiestático con soporte variable VESA 100-400
Chariot pour appareils pour moniteur, hauteur 132cm, antistatique avec support variable VESA 100-400



Weitere HD oder 4K Monitore / Drucker / Speichersysteme auf Anfrage erhältlich
Further HD or 4K monitors / printers / capture systems from various other suppliers on request
Más monitores HD o 4K / impresores / sistemas de almacenamiento bajo demanda
D'autres moniteurs / imprimantes / systèmes de saisie images d'autres fournisseurs sur demande

**GERÄTEWAGEN / TROLLEYS
CARROS PARA EQUIPO / CHARIOTS D'EQUIPEMENT**

Gerätewagen können nach Kundenwunsch zusammengestellt werden
Equipment carts can be offered according to customers requests
Carros se pueden poner juntos de acuerdo a los requerimientos del cliente
Les chariots d'équipement peuvent être combinés selon demande du client



Description	238-70-100	238-70-110	238-71-100	238-72-100	238-74-100
Höhe / height altura / hauteur	112 cm	112 cm	112 cm	147 cm	147 cm
Ablageboden / shelves estanterías / étagères	2	2	2	3	3
Ablageboden mit Griff / shelf with handle estanterías con mango / étagère avec poignée	1	1	1	1	1
Ablageboden Monitor / monitor shelf estanterías para monitor / étagère pour moniteur	1	-	-	-	-
Quertraverse mit Monitorhalterung crossbar with monitor support travesaño con soporte de monitor traverse avec support de moniteur	-	1	1	1	1
Schublade / drawer cajón / tiroir	-	-	-	1	1
Kamerakopfhaltung / camera head holding device montaje en cabeza de la cámara / dispositif support tête caméra	1	1	1	1	1
Euro Steckerleiste 6-fach / Euro socket strip 6-fold enchufe Euro 6 veces / prise multiple Euro 6 fois	-	-	1	-	1
antistatische Rollen / antistatic castors rodillos antiestáticos / rouleaux antistatiques	1	1	1	1	1

Schwenkarm / swivel arm / brazo giratorio / bras pivotant	238-75-600
Befestigungsset / fixation set / kit de montage / kit de fixation	238-75-601



CO2 Flaschenhalter / CO2 bottle holder soporte para botellas CO2 / fixation bouteille CO2	238-75-630
--	------------

Gegengewicht / counterbalance / contrapeso / contrepoids (15kg)	238-75-650
---	------------

Trenntransformator / isolating transformer / transformador de aislamiento /transformateur d'isolement (20kg)	238-75-690
---	------------

ELCON
MEDICAL INSTRUMENTS GmbH

ELCON

MEDICAL INSTRUMENTS GmbH

D - 78532 Tuttlingen
Tel: +49 7461 9281-0
info@elcon-medical.de

Dr. Karl-Storz-Str. 26
Fax: +49 7461 9281-29
www.elcon-medical.com