

UNIVERSAL RING RETRAKTOR SYSTEM
UNIVERSAL RING RETRACTOR SYSTEM
UNIVERSAL ANNEAU RÉTRACTEUR SYSTEM
UNIVERSAL ANILLO RETRACTOR SYSTEM

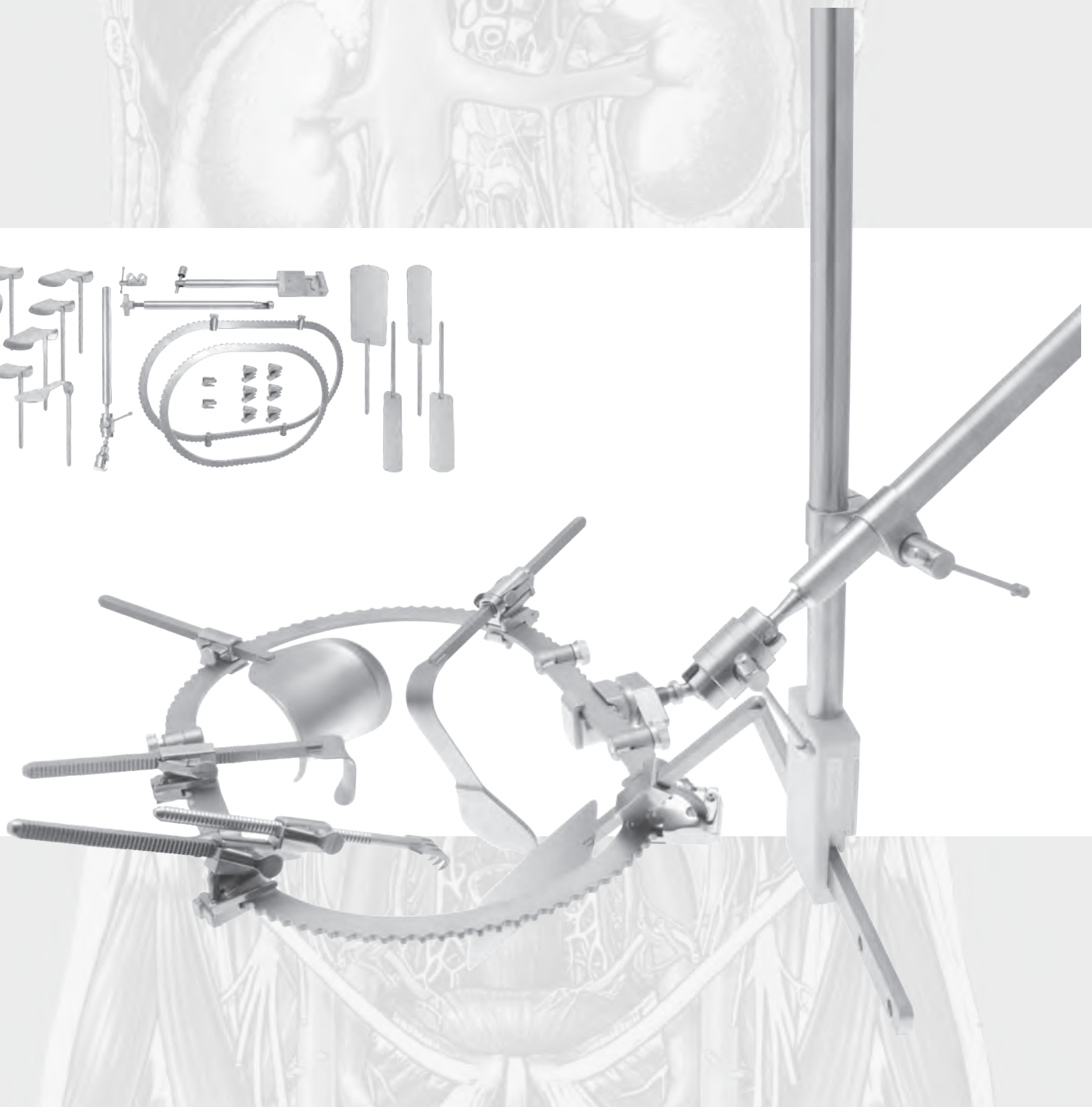

wide range of top quality instruments

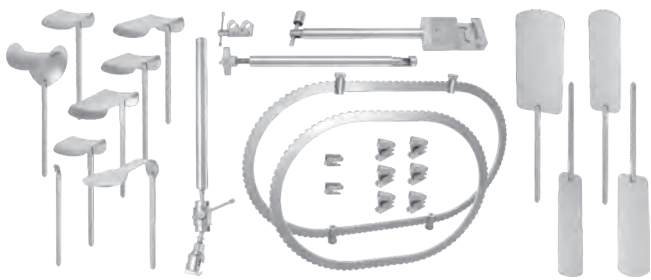

ELCON was founded in the year 1977 by Mr. H.R. Jakobi and a group of professionals with experience of many years in the field of surgical instruments.

All activities and products of ELCON are part of a continuous quality and safety control.

We are certified according to EN ISO 13485 and FDA registered.
Downloads under: www.elcon-medical.com

ELCON

RET 01 - RET21

172

RING RETRAKTOR
RING RETRACTOR
ANNEAU RÉTRACTEUR
ANILLO RETRACTOR



Die aktuellen Informationen bezüglich der Risikoklasse der ELCON Produkte finden Sie auf unserer Homepage unter „Produkt finden“

You can find the latest information on risk classes of ELCON products on our homepage under “Find product.”

Las informaciones actualizadas sobre la clase de riesgo de los productos ELCON se encuentran en nuestra página web bajo „Buscar producto“

Vous trouverez les informations actuelles concernant la classe de risque des produit ELCON sur notre page d'accueil, sous la rubrique „Trouver un produit“

ELCON 172

RING RETRAKTOR
RING RETRACTOR
ANNEAU RÉTRACTEUR
ANILLO RETRACTOR

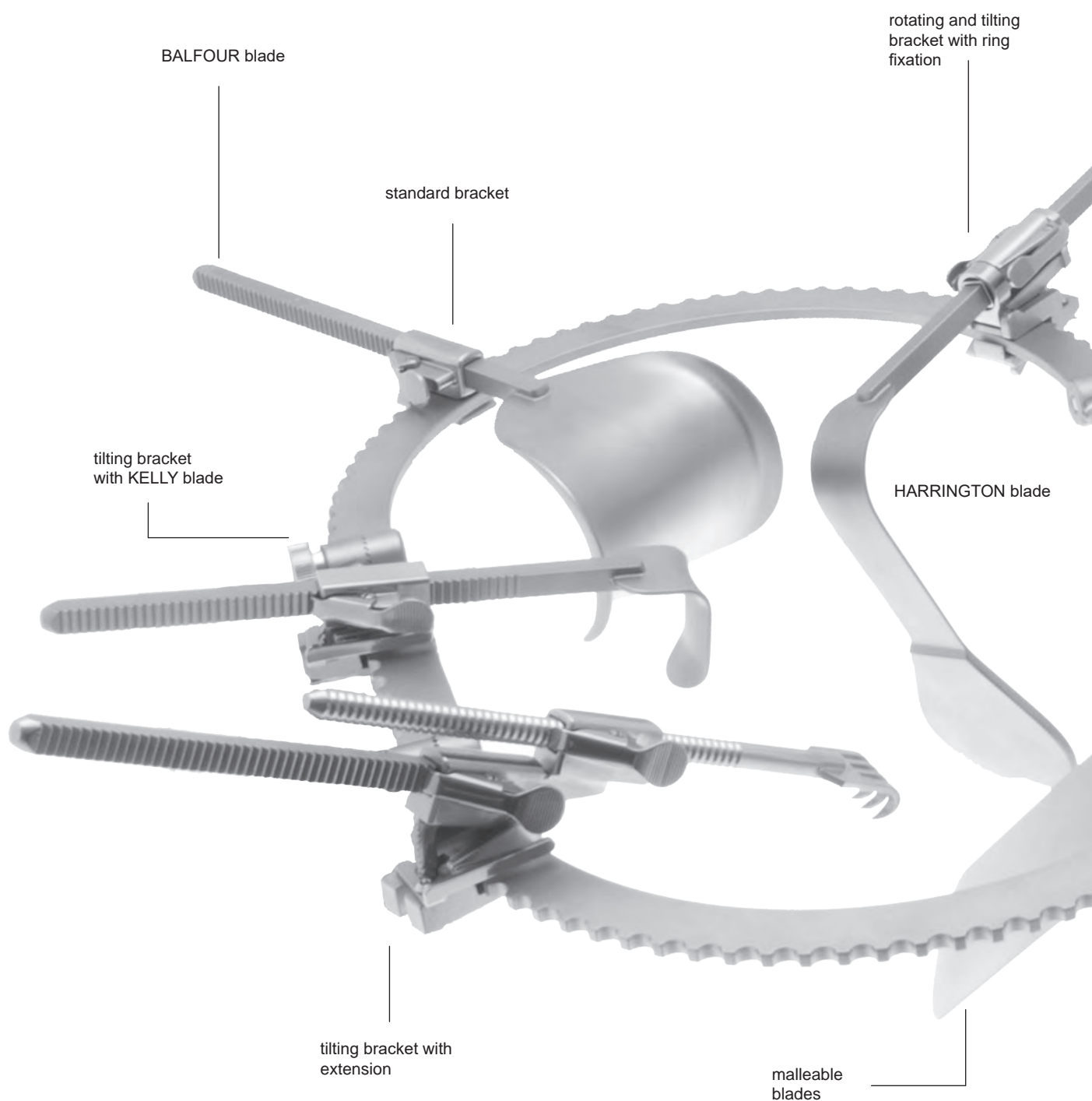

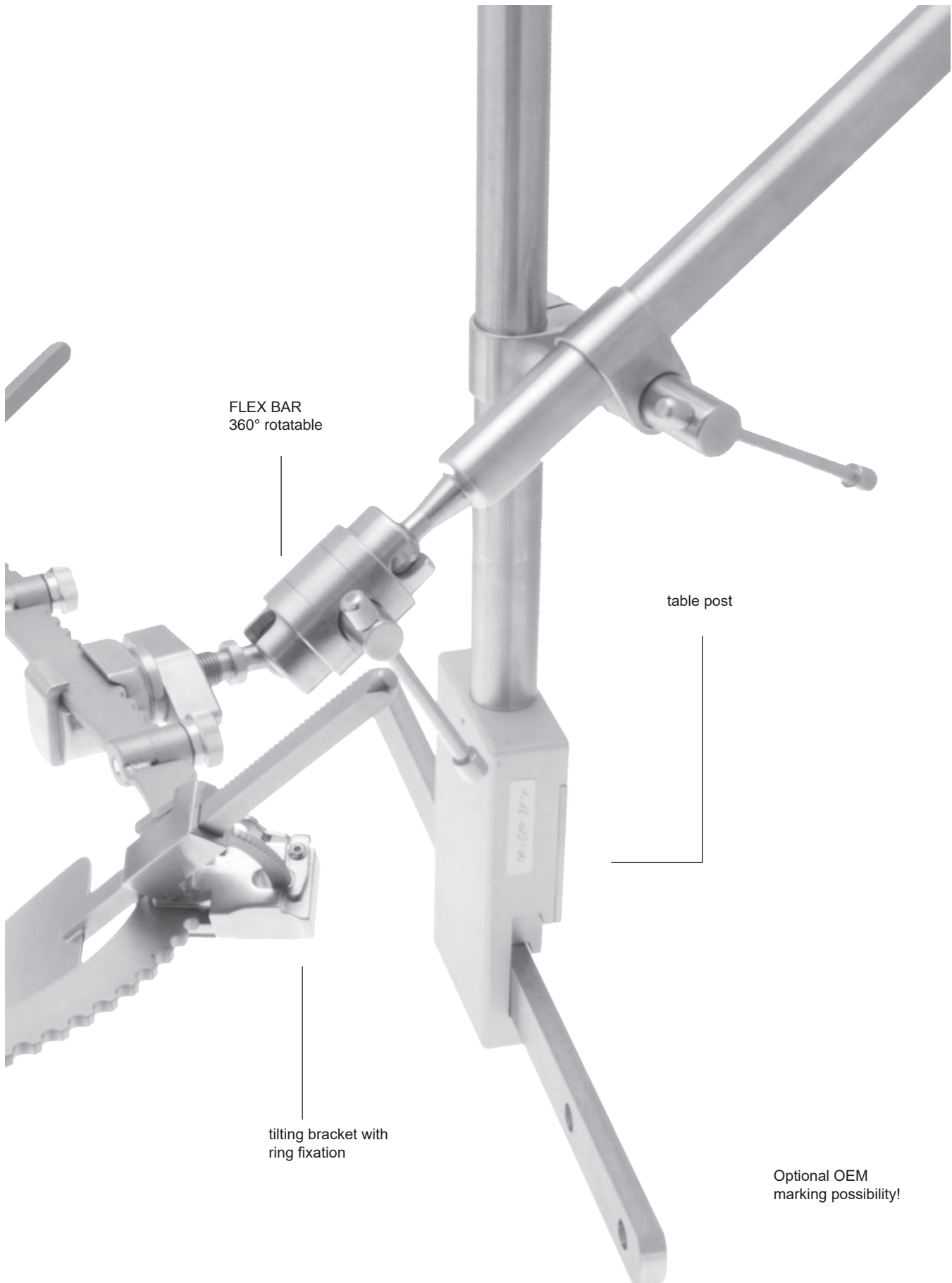

FLEX BAR
360° rotatable

table post

tilting bracket with
ring fixation







Optional OEM
marking possibility!

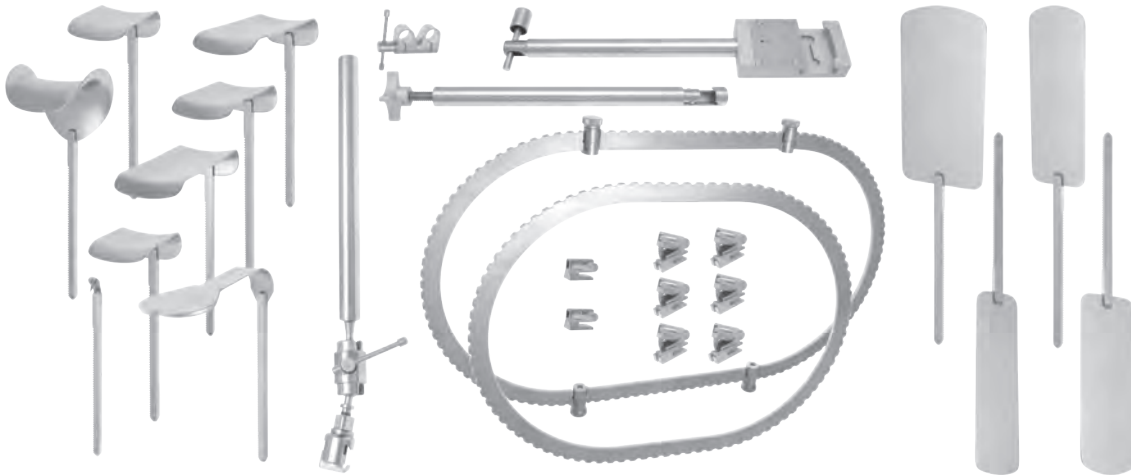











ELCON 172

RING RETRAKTOR
RING RETRACTOR
ANNEAU RÉTRACTEUR
ANILLO RETRACTOR

RETRAKTOR SYSTEM FÜR DIE ALLGEMEINE CHIRURGIE
RETRACTOR SYSTEM FOR GENERAL SURGERY
SYSTÈME DE RÉTRACTION POUR LA CHIRURGIE GÉNÉRALE
SISTEMA RETRACTOR PARA CIRUGÍA GENERAL



| | | description | dimensions | qty. |
|---------|---|---------------------------------------|-----------------|------|
| 172-030 |  | TABLE POST | 365 MM, Ø 25 MM | 1 |
| 172-031 |  | HORIZONTAL BAR | 365 MM Ø 25 MM | 1 |
| 172-032 |  | HORIZONTAL FLEX BAR 360° ROTATABLE | Ø 25 MM | 1 |
| 172-033 |  | POST COUPLING | FOR Ø 25 MM | 1 |
| 172-073 |  | SEGMENTED RING | 495 X 265 MM | 1 |
| 172-051 |  | OVAL RING | 368 X 267 MM | 1 |





| | | description | dimensions | qty. |
|---------|---|-------------------|-------------|------|
| 172-034 |  | RATCHET | | 2 |
| 172-036 |  | TILT RATCHET | | 6 |
| 172-142 |  | KELLY BLADE | 76 X 51 MM | 2 |
| 172-144 |  | KELLY BLADE | 102 X 51 MM | 1 |
| 172-146 |  | KELLY BLADE | 127 X 51 MM | 1 |
| 172-148 |  | KELLY BLADE | 152 X 51 MM | 1 |
| 172-102 |  | SPATULA MALLEABLE | 152 X 38 MM | 1 |
| 172-104 |  | SPATULA MALLEABLE | 152 X 51 MM | 2 |
| 172-106 |  | SPATULA MALLEABLE | 152 X 76 MM | 1 |
| 172-120 |  | BALFOUR BLADE | 67 X 76 MM | 1 |
| 172-160 |  | HARRINGTON BLADE | 143 X 63 MM | 1 |
| 172-150 |  | GELPI BLADE SHARP | | 1 |



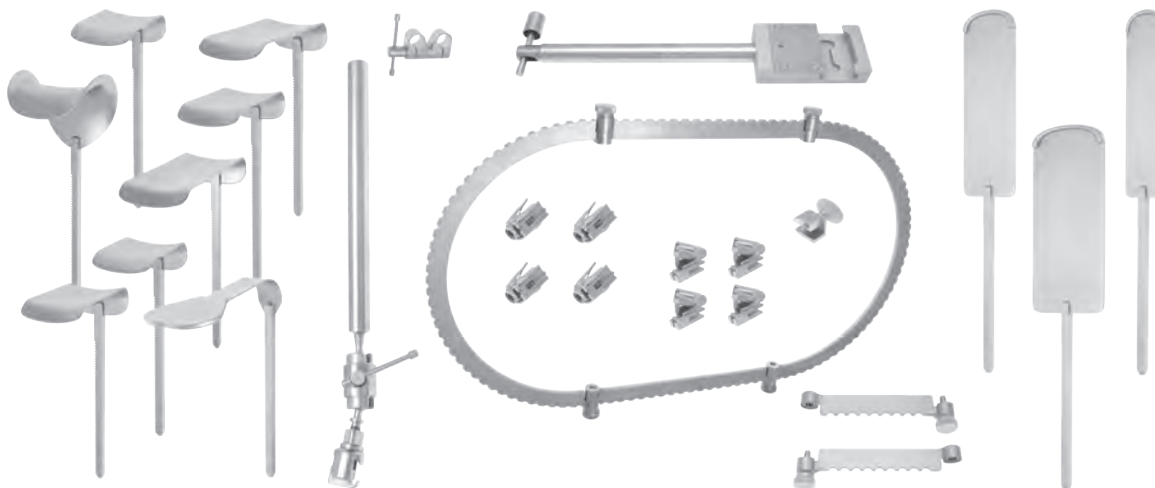



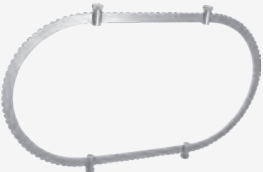



ELCON 172

RING RETRAKTOR
RING RETRACTOR
ANNEAU RÉTRACTEUR
ANILLO RETRACTOR

RETRAKTOR SYSTEM FÜR DIE ALLGEMEINE CHIRURGIE / CLASSIC
RETRACTOR SYSTEM FOR GENERAL SURGERY / CLASSIC
SYSTÈME DE RÉTRACTION POUR LA CHIRURGIE GÉNÉRALE / CLASSIC
SISTEMA RETRACTOR PARA CIRUGÍA GENERAL / CLASSIC









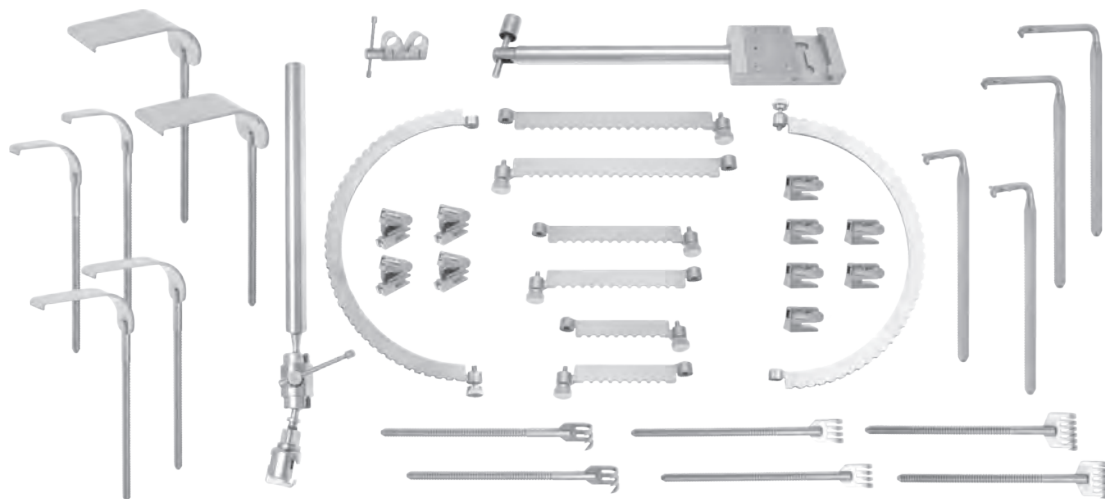









| | | description | dimensions | qty. |
|---------|---|---------------------------------------|-----------------|------|
| 172-030 |  | TABLE POST | 365 MM, Ø 25 MM | 1 |
| 172-033 |  | POST COUPLING | FOR Ø 25 MM | 1 |
| 172-032 |  | HORIZONTAL FLEX BAR 360° ROTATABLE | Ø 25 MM | 1 |
| 172-073 |  | SEGMENTED RING | 495 X 265 MM | 1 |
| 172-086 |  | CONTINUUM STRAIGHT SEGMENT pair | 100 MM | 1 |
| 172-035 |  | TWISTER RATCHET | | 1 |

| | | description | dimensions | qty. |
|-----------|---|--|-------------|------|
| 172-037-1 |  | TILT RATCHET ROTATABLE WITH RING FIXATION | | 4 |
| 172-036 |  | TILT RATCHET | | 4 |
| 172-142 |  | KELLY BLADE | 76 X 51 MM | 2 |
| 172-144 |  | KELLY BLADE | 102 X 51 MM | 2 |
| 172-146 |  | KELLY BLADE | 127 X 51 MM | 1 |
| 172-148 |  | KELLY BLADE | 152 X 51 MM | 1 |
| 172-110 |  | MALLEABLE BLADE with protective end | 152 X 38 MM | 1 |
| 172-111 |  | MALLEABLE BLADE with protective end | 152 X 51 MM | 2 |
| 172-112 |  | MALLEABLE BLADE with protective end | 152 X 76 MM | 1 |
| 172-120 |  | BALFOUR BLADE | 67 X 76 MM | 1 |
| 172-160 |  | HARRINGTON BLADE | 143 X 63 MM | 1 |

RETRAKTORSYSTEM FÜR DIE WIRBELSÄULENCHIRURGIE
RETRACTOR SYSTEM FOR SPINAL SURGERY
SYSTÈME DE RÉTRACTION POUR LA CHIRURGIE DE LA COLONNE VERTÉBRALE
SISTEMA RETRACTOR PARA CIRUGÍA DE LA COLUMNA VERTEBRAL

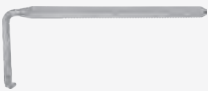

| | | description | dimensions | qty. |
|---------|---|---------------------------------------|-----------------|------|
| 172-030 |  | TABLE POST | 365 MM, Ø 25 MM | 1 |
| 172-032 |  | HORIZONTAL FLEX BAR 360° ROTABLE | Ø 25 MM | 1 |
| 172-033 |  | POST COUPLING | FOR Ø 25 MM | 1 |
| 172-085 |  | CONTINUUM SEGMENTED RING | Ø 216 MM | 1 |
| 172-086 |  | CONTINUUM STRAIGHT SEGMENT pair | 100 MM | 1 |
| 172-087 |  | CONTINUUM STRAIGHT SEGMENT pair | 150 MM | 1 |







| | | description | dimensions | qty. |
|---------|---|---------------------------------------|------------|------|
| 172-088 |  | CONTINUUM STRAIGHT SEGMENT pair | 200 MM | 1 |
| 172-034 |  | RATCHET | | 6 |
| 172-036 |  | TILT RATCHET | | 4 |
| 172-151 |  | MEYERDING BLADE | 17 X 60 MM | 2 |
| 172-152 |  | MEYERDING BLADE | 25 X 85 MM | 2 |
| 172-153 |  | MEYERDING BLADE | 50 X 95 MM | 2 |
| 172-156 |  | SCOVILLE HOOK | 50 MM | 2 |
| 172-157 |  | SCOVILLE HOOK | 83 MM | 2 |
| 172-183 |  | RAKE RETRACTOR, SHARP | 3 PRONGS | 2 |
| 172-184 |  | RAKE RETRACTOR, SHARP | 4 PRONGS | 2 |
| 172-186 |  | RAKE RETRACTOR, SHARP | 6 PRONGS | 2 |

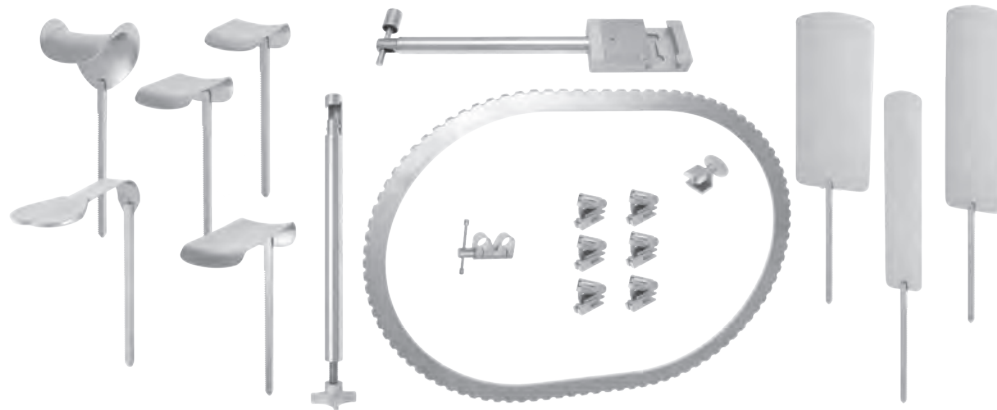







ELCON 172

RING RETRAKTOR
RING RETRACTOR
ANNEAU RÉTRACTEUR
ANILLO RETRACTOR

RETRAKTOR SYSTEM FÜR DIE BARIATRISCHE CHIRURGIE
RETRACTOR SYSTEM FOR BARIATRIC SURGERY
SYSTÈME DE RÉTRACTION POUR LA CHIRURGIE BARIATRIQUE
SISTEMA RETRACTOR PARA CIRUGÍA BARIÁTRICA



| | | description | dimensions | qty. |
|-----------|---|-----------------|-----------------|------|
| 172-030-1 |  | TABLE POST | 450 MM, Ø 25 MM | 1 |
| 172-031 |  | HORIZONTAL BAR | 365 MM Ø 25 MM | 1 |
| 172-033 |  | POST COUPLING | FOR Ø 25 MM | 1 |
| 172-051 |  | OVAL RING | 368 X 267 MM | 1 |
| 172-036 |  | TILT RATCHET | | 6 |
| 172-035 |  | TWISTER RATCHET | | 1 |

| | | description | dimensions | qty. |
|-----------|---|-------------------|--------------|------|
| 172-034-1 |  | RATCHET EXTENSION | | 1 |
| 172-105 |  | SPATULA MALLEABLE | 254 X 51 MM | 1 |
| 172-107 |  | SPATULA MALLEABLE | 254 X 76 MM | 1 |
| 172-108 |  | SPATULA MALLEABLE | 203 X 102 MM | 1 |
| 172-142 |  | KELLY BLADE | 76 X 51 MM | 1 |
| 172-144 |  | KELLY BLADE | 102 X 51 MM | 1 |
| 172-148 |  | KELLY BLADE | 152 X 51 MM | 1 |
| 172-161 |  | HARRINGTON BLADE | 254 x 89 MM | 1 |
| 172-120 |  | BALFOUR BLADE | 67 X 76 MM | 1 |

ELCON 172

RING RETRAKTOR
RING RETRACTOR
ANNEAU RÉTRACTEUR
ANILLO RETRACTOR

RETRAKTOR SYSTEM FÜR DIE GYNÄKOLOGISCHE CHIRURGIE
RETRACTOR SYSTEM FOR GYNECOLOGY SURGERY
SYSTÈME DE RÉTRACTION POUR LA CHIRURGIE GYNÉCOLOGIQUE
SISTEMA RETRACTOR PARA CIRUGÍA GINECOLÓGICA

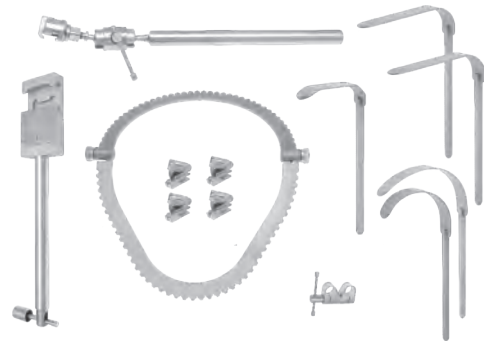

| | | description | dimensions | qty. |
|---------|---|---------------------------------------|-----------------|------|
| 172-030 |  | TABLE POST | 365 MM, Ø 25 MM | 1 |
| 172-032 |  | HORIZONTAL FLEX BAR 360° ROTATABLE | Ø 25 MM | 1 |
| 172-033 |  | POST COUPLING | FOR Ø 25 MM | 1 |
| 172-065 |  | SEGMENTED RING | 265 X 200 MM | 1 |
| 172-037 |  | TILT RATCHET WITH RING FIXATION | | 4 |
| 172-230 |  | VAGINAL BLADE lateral | 76 X 25 MM | 2 |
| 172-234 |  | VAGINAL BLADE posterior | 114 X 25 MM | 1 |
| 172-242 |  | DEAVER BLADE vaginal | 89 X 25 MM | 1 |
| 172-243 |  | DEAVER BLADE vaginal | 127 X 25 MM | 1 |

ERWEITERUNGSMODUL FÜR KLEINE EINGRIFFE
EXTENSION MODULE FOR MINOR SURGERY
MODULE D'EXTENSION POUR LA CHIRURGIE PETITE
MÓDULO DE EXTENSIÓN PARA CIRUGIA MENOR

| |  | description | dimensions | qty. |
|---------|---|-------------------|------------|------|
| 172-055 |  | ROUND RING | Ø 216 MM | 1 |
| 172-134 |  | KELLY BLADE | 38 X 25 MM | 1 |
| 172-135 |  | KELLY BLADE | 63 X 25 MM | 1 |
| 172-150 |  | GELPI BLADE SHARP | | 1 |

ERWEITERUNGSMODUL FÜR REKTALE EINGRIFFE
EXTENSION MODULE FOR RECTAL SURGERY
MODULE D'EXTENSION POUR LA CHIRURGIE RECTALE
MÓDULO DE EXTENSIÓN PARA CIRUGIA RECTAL





| | | description | dimensions | qty. |
|---------|---|--------------|-------------|------|
| 172-055 |  | ROUND RING | Ø 216 MM | 1 |
| 172-220 |  | RECTAL BLADE | 70 X 22 MM | 2 |
| 172-222 |  | RECTAL BLADE | 100 X 22 MM | 2 |

TABLE POSTS AND HORIZONTAL BARS



| TABLE POST | | Ø | length | item no. |
|------------|--|-------|--------|------------------|
| | | 25 mm | 365 mm | 172-030* |
| | | 25 mm | 450 mm | 172-030-1 |
| |  post holder only | 25 mm | | 172-030-2 |



| HORIZONTAL BAR | | Ø | length | item no. |
|----------------|--|-------|--------|----------------|
| | | 25 mm | 365 mm | 172-031 |



| HORIZONTAL FLEX BAR / 360° ROTATABLE | | Ø | length | item no. |
|--------------------------------------|--|-------|--------|----------------|
| | | 25 mm | | 172-032 |



| EXTENSION BAR | | Ø | length | item no. |
|---------------|--|-------|--------|------------------|
| | | 25 mm | 300 mm | 172-038* |
| | | 25 mm | 460 mm | 172-038-1 |



| POST COUPLING | | Ø | length | item no. |
|---------------|--|-------|--------|----------------|
| | | 25 mm | | 172-033 |

* shown item



| | |
|-------------------|------------------|
| RATCHET EXTENSION | item no. |
| | 172-034-1 |

| | |
|------------------|----------------|
| STANDARD RATCHET | item no. |
| | 172-034 |



| | |
|--------------|----------------|
| TILT RATCHET | item no. |
| | 172-036 |



| | |
|---------------------------------|----------------|
| TILT RATCHET WITH RING FIXATION | item no. |
| | 172-037 |



| | |
|---|------------------|
| TILT RATCHET ROTATABLE WITH RING FIXATION | item no. |
| | 172-037-1 |



| | |
|-----------------|----------------|
| TWISTER RATCHET | item no. |
| | 172-035 |



RETRACTION RINGS



| OVAL RINGS | item no. |
|---------------------------------|----------------|
| 311 x 203 mm, 12 1/4" x 8" | 172-050 |
| 368 x 267 mm, 14 1/2" x 10 1/2" | 172-051 |
| 470 x 305 mm, 18 1/2" x 12" | 172-052 |



| ROUND RINGS | item no. |
|-------------------|----------------|
| Ø 216 mm, 8 1/2" | 172-055 |
| Ø 265 mm, 10 1/2" | 172-060 |
| Ø 315 mm, 12 1/2" | 172-061 |



| SEGMENTED RINGS | item no. |
|---------------------------------|----------------|
| 356 x 216 mm, 14" x 8 1/2" | 172-071 |
| 495 x 265 mm, 19 1/2" x 10 1/2" | 172-073 |
| 495 x 315 mm, 19 1/2" x 12 1/2" | 172-075 |



| SEGMENTED ROUND RINGS | item no. |
|------------------------|----------------|
| Ø 216 mm, 8 1/2" pair | 172-085 |
| Ø 265 mm, 10 1/2" pair | 172-084 |



| SEGMENTED EXTENSION FOR RINGS | item no. |
|-------------------------------|----------------|
| 100 mm | 172-086 |
| 150 mm | 172-087 |
| 200 mm | 172-088 |

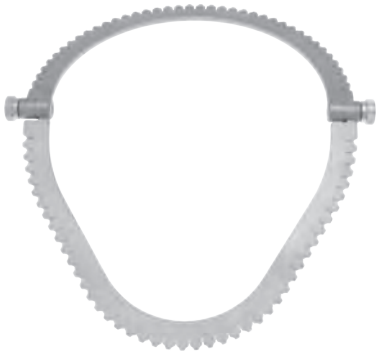

| SEGMENTED RING | item no. |
|----------------------------|----------------|
| 265 x 200 mm, 10 1/2" x 8" | 172-065 |

BLADES

| MALLEABLE BLADE | item no. |
|-----------------|----------------|
| 152 x 38 mm | 172-102 |
| 152 x 51 mm | 172-104 |
| 254 x 51 mm | 172-105 |
| 152 x 76 mm | 172-106 |
| 254 x 76 mm | 172-107 |
| 203 x 102 mm | 172-108 |



| MALLEABLE BLADE with protective end | item no. |
|--|----------------|
| 152 x 38 mm | 172-110 |
| 152 x 51 mm | 172-111 |
| 152 x 76 mm | 172-112 |
| 102 x 25 mm | 172-113 |



| BALFOUR BLADE | item no. |
|---------------|----------------|
| 67 X 76 mm | 172-120 |
| 89 X 70 mm | 172-121 |



| KELLY BLADE | item no. |
|-------------|----------------|
| 64 x 51 mm | 172-130 |
| 38 x 25 mm | 172-134 |
| 63 x 25 mm | 172-135 |
| 38 x 51 mm | 172-140 |
| 76 x 51 mm | 172-142 |
| 102 x 51 mm | 172-144 |
| 127 x 51 mm | 172-146 |
| 152 x 51 mm | 172-148 |



| GELPI BLADE | item no. |
|-------------|----------------|
| sharp | 172-150 |



| MEYERDING BLADE | item no. |
|-----------------|----------------|
| 17 x 60 mm | 172-151 |
| 25 x 85 mm | 172-152 |
| 50 x 95 mm | 172-153 |

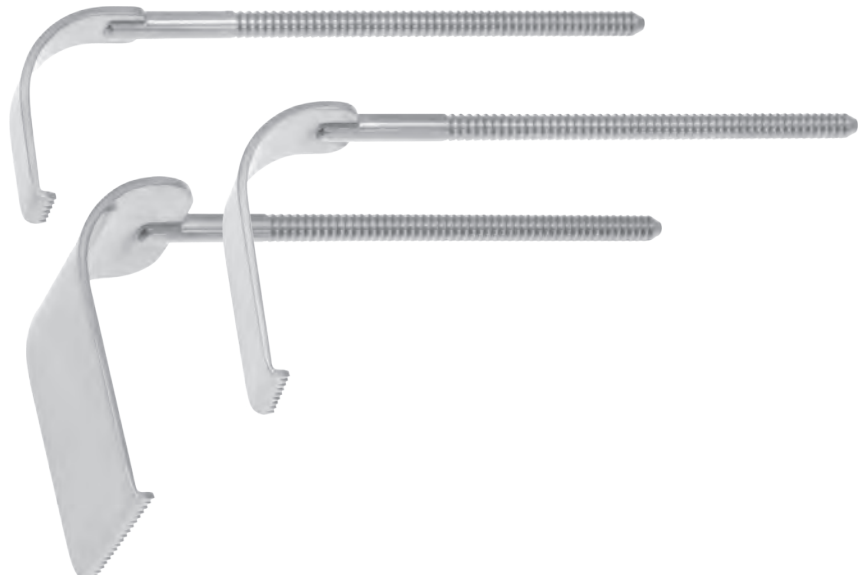

| SCOVILLE HOOK | item no. |
|---------------|----------------|
| 50 mm | 172-156 |
| 83 mm | 172-157 |



| HARRINGTON BLADE | item no. |
|------------------|----------------|
| 143 x 63 mm | 172-160 |
| 254 x 89 mm | 172-161 |



| RICHARDSON BLADE | item no. |
|------------------|----------------|
| 25 x 19 mm | 172-170 |
| 51 x 19 mm | 172-171 |
| 32 x 25 mm | 172-172 |



| RAKE BLADE | item no. |
|----------------------|----------------|
| 19 x 17 mm (3 prong) | 172-183 |
| 9 x 19 mm (4 prong) | 172-184 |
| 9 x 29 mm (6 prong) | 172-186 |



| RECTAL BLADE | item no. |
|--------------|----------------|
| 70 x 22 mm | 172-220 |
| 100 x 22 mm | 172-222 |



ELCON 172

RING RETRAKTOR
RING RETRACTOR
ANNEAU RÉTRACTEUR
ANILLO RETRACTOR

| | |
|--------------------------|----------------|
| VAGINAL BLADE lateral | item no. |
| 76 x 25 mm | 172-230 |



| | |
|----------------------------|----------------|
| VAGINAL BLADE posterior | item no. |
| 114 x 25 mm | 172-234 |



| | |
|-------------------------|----------------|
| DEAVER BLADE vaginal | item no. |
| 89 x 25 mm | 172-242 |
| 127 x 25 mm | 172-243 |



| | |
|-----------------------|----------------|
| IMA RETRACTOR | item no. |
| RATCHET | 172-251 |
| HORIZONTAL BAR 300 mm | 172-250 |
| IMA BLADE (4 prong) | 172-252 |

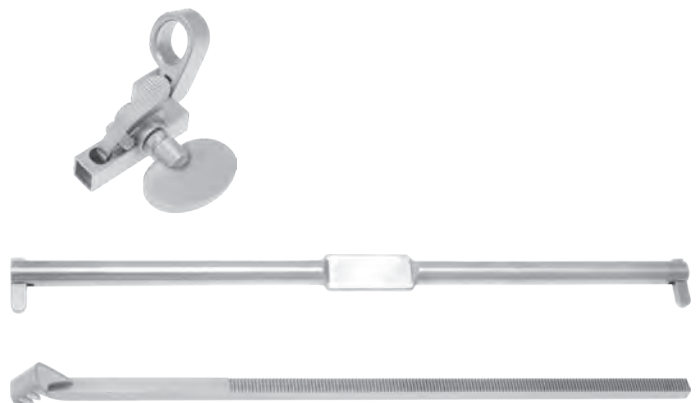

ELCON

MEDICAL INSTRUMENTS GmbH

D - 78532 Tuttlingen
Tel: +49 7461 9281-0
info@elcon-medical.de

Dr. Karl-Storz-Str. 26
Fax: +49 7461 9281-29
www.elcon-medical.com