

UNIVERSAL RING RETRAKTOR SYSTEM  
UNIVERSAL RING RETRACTOR SYSTEM  
UNIVERSAL ANNEAU RÉTRACTEUR SYSTEM  
UNIVERSAL ANILLO RETRACTOR SYSTEM

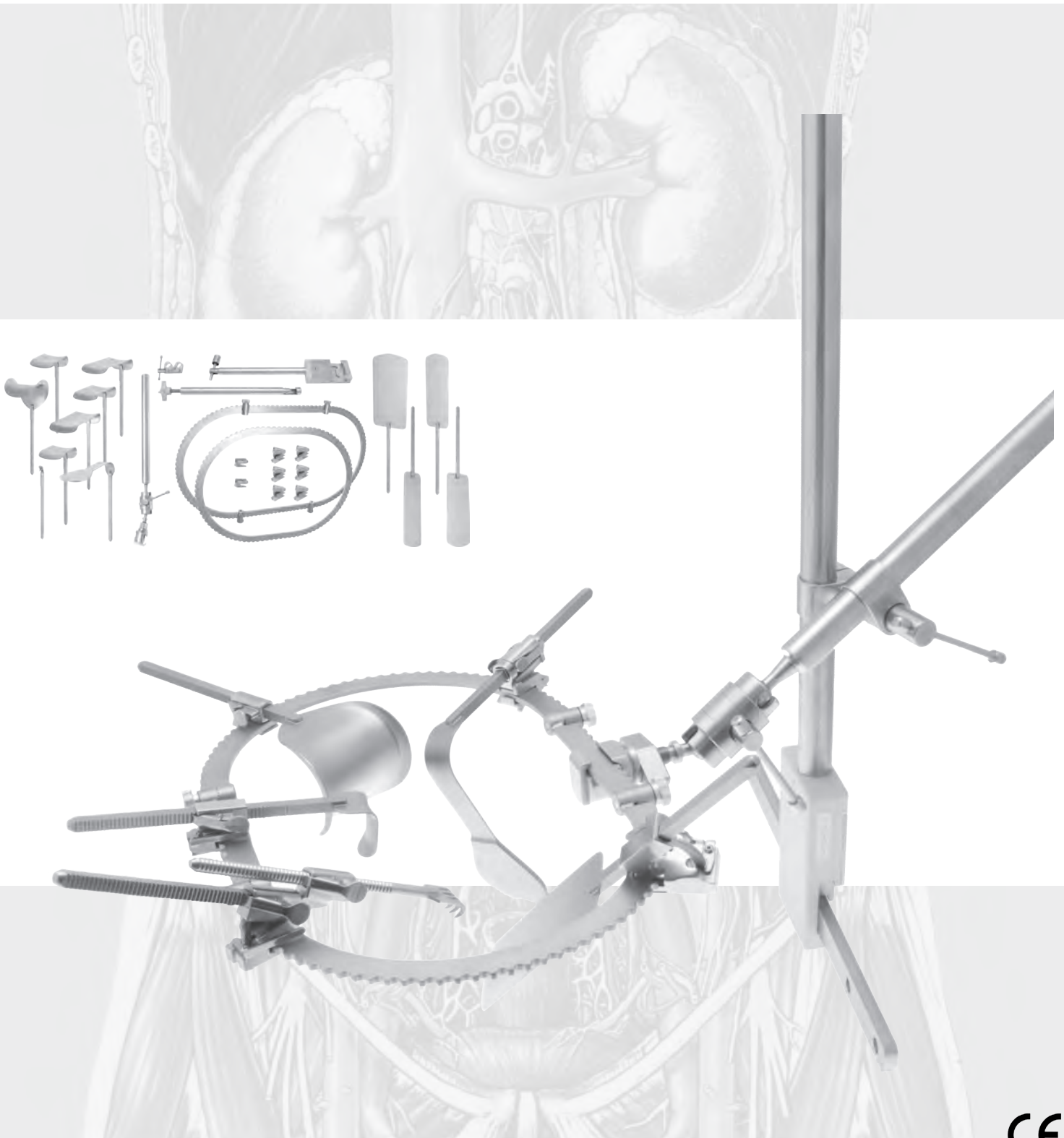

wide range of top quality instruments



ELCON was founded in the year 1977 by Mr. H.R. Jakobi and a group of professionals with experience of many years in the field of surgical instruments.

All activities and products of ELCON are part of a continuous quality and safety control.

We are certified according to EN ISO 13485 and FDA registered.  
Downloads under: [www.elcon-medical.com](http://www.elcon-medical.com)

**ELCON**  
RET 01 - RET21

**172**

**RING RETRAKTOR  
RING RETRACTOR  
ANNEAU RÉTRACTEUR  
ANILLO RETRACTOR**

# ELCON 172

RING RETRAKTOR  
RING RETRACTOR  
ANNEAU RÉTRACTEUR  
ANILLO RETRACTOR

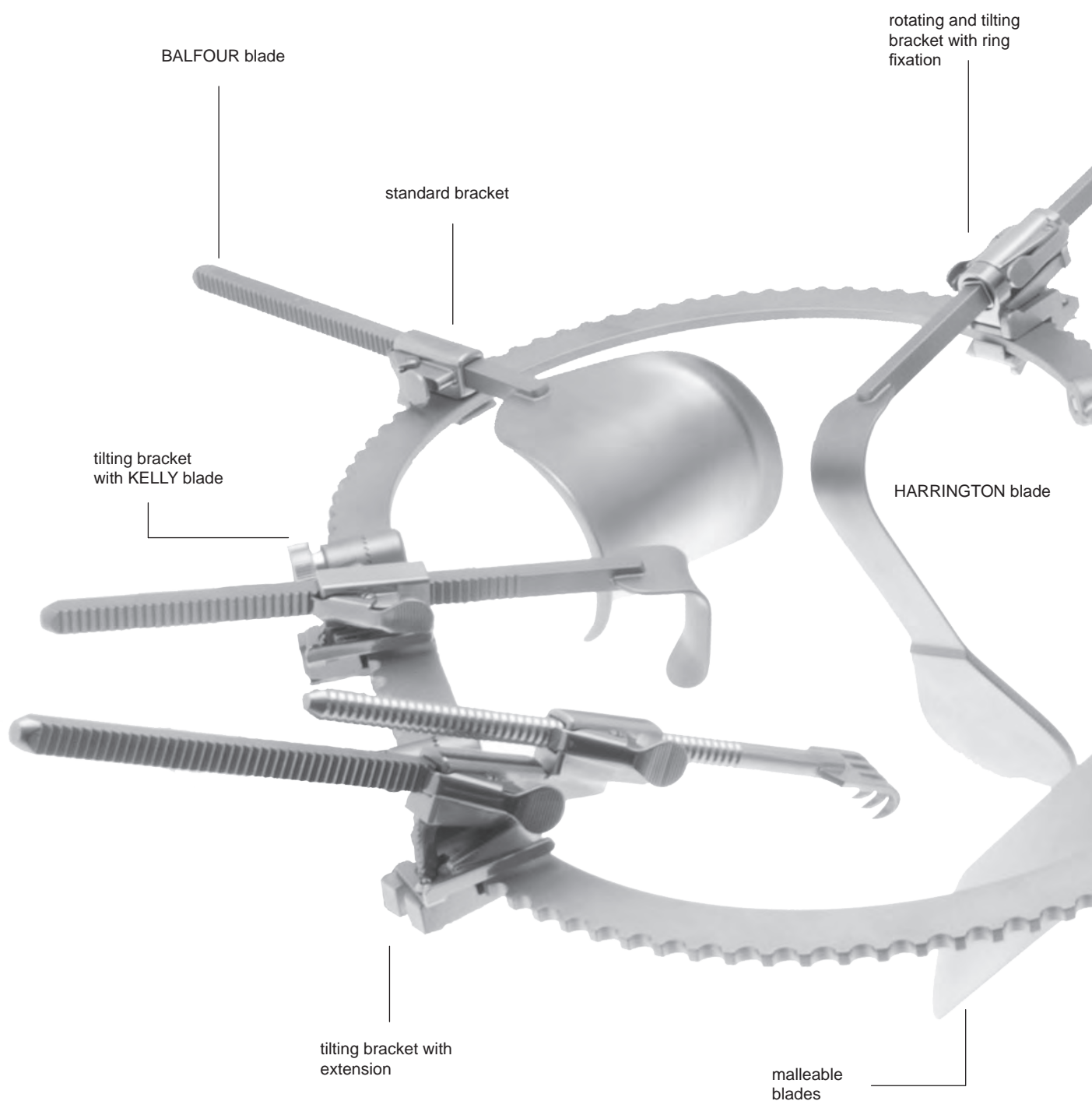

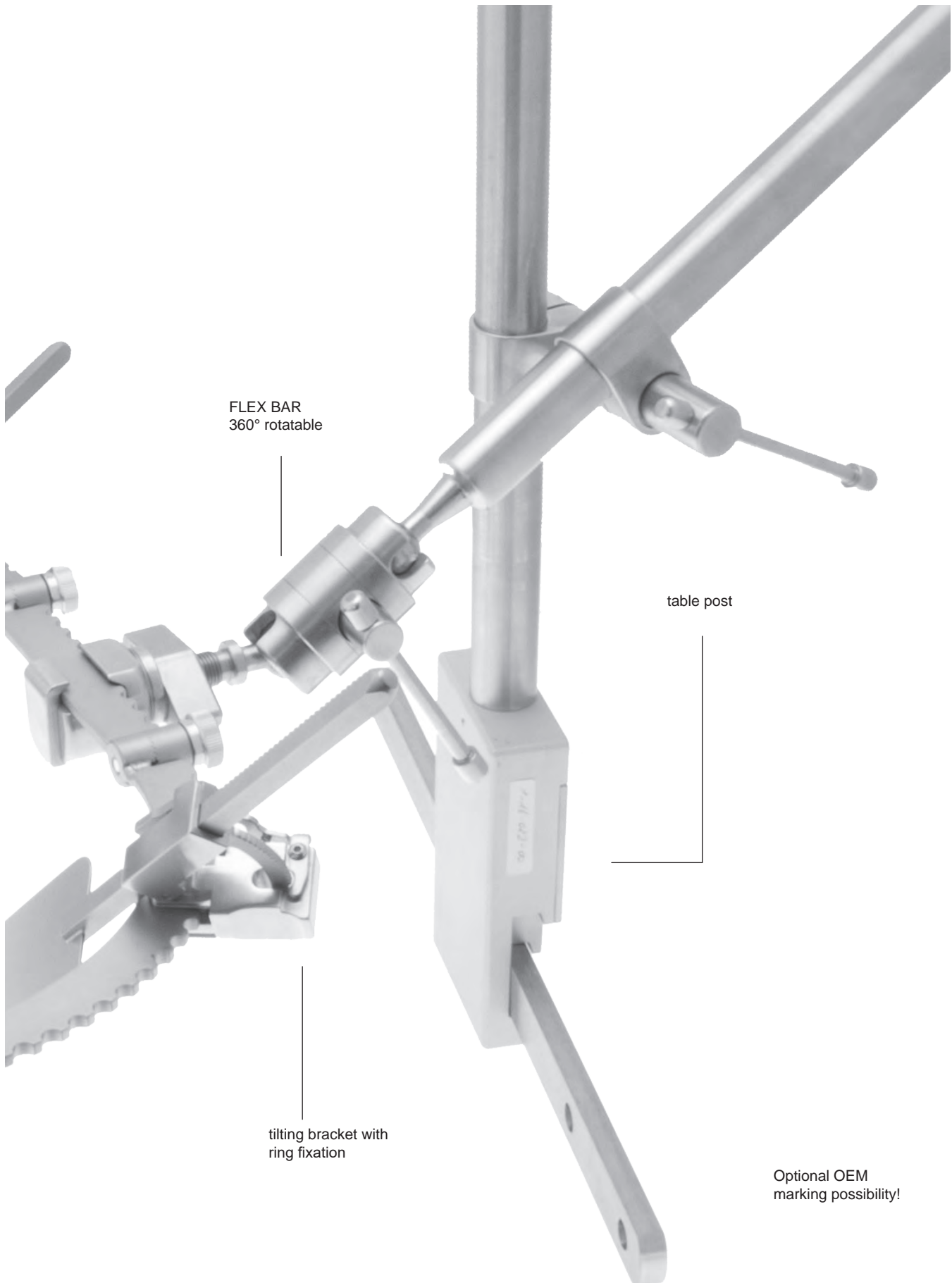

FLEX BAR  
360° rotatable

table post

tilting bracket with  
ring fixation







Optional OEM  
marking possibility!

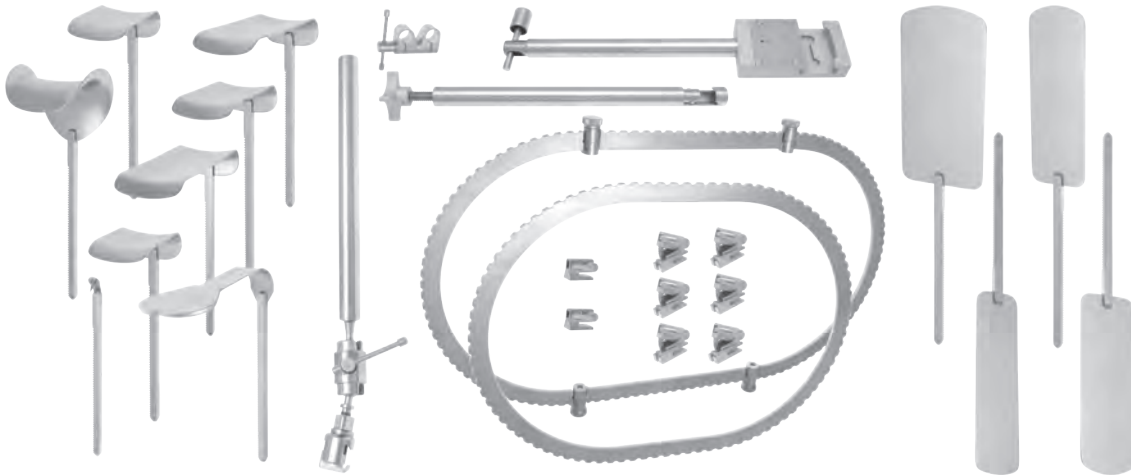











# ELCON 172

RING RETRAKTOR  
RING RETRACTOR  
ANNEAU RÉTRACTEUR  
ANILLO RETRACTOR

RETRAKTOR SYSTEM FÜR DIE ALLGEMEINE CHIRURGIE  
RETRACTOR SYSTEM FOR GENERAL SURGERY  
SYSTÈME DE RÉTRACTION POUR LA CHIRURGIE GÉNÉRALE  
SISTEMA RETRACTOR PARA CIRUGÍA GENERAL



		description	dimensions	qty.
172-030		TABLE POST	365 MM, Ø 25 MM	1
172-031		HORIZONTAL BAR	365 MM Ø 25 MM	1
172-032		HORIZONTAL FLEX BAR 360° ROTATABLE	Ø 25 MM	1
172-033		POST COUPLING	FOR Ø 25 MM	1
172-073		SEGMENTED RING	495 X 265 MM	1
172-051		OVAL RING	368 X 267 MM	1





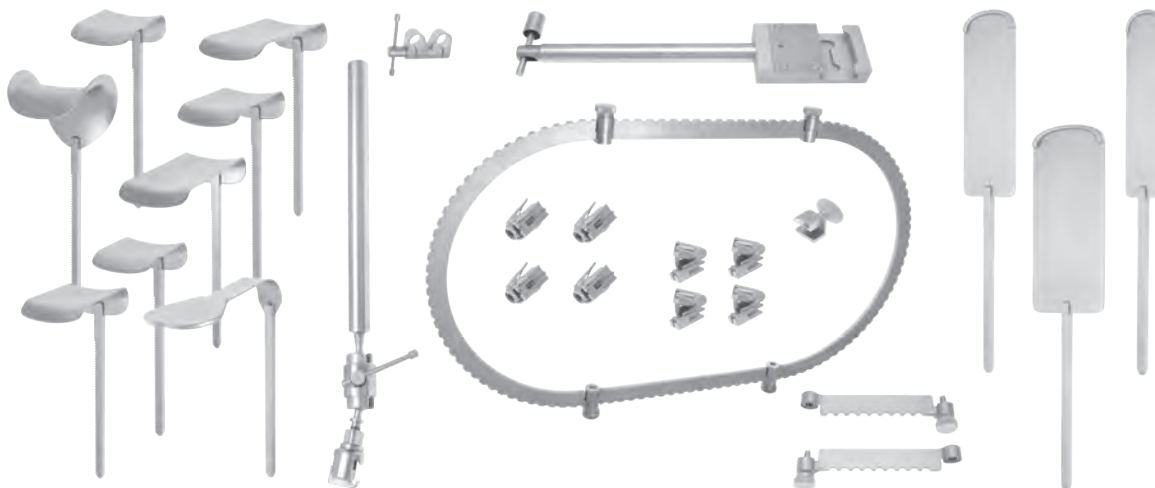

		description	dimensions	qty.
172-034		RATCHET		2
172-036		TILT RATCHET		6
172-142		KELLY BLADE	76 X 51 MM	2
172-144		KELLY BLADE	102 X 51 MM	1
172-146		KELLY BLADE	127 X 51 MM	1
172-148		KELLY BLADE	152 X 51 MM	1
172-102		SPATULA MALLEABLE	152 X 38 MM	1
172-104		SPATULA MALLEABLE	152 X 51 MM	2
172-106		SPATULA MALLEABLE	152 X 76 MM	1
172-120		BALFOUR BLADE	67 X 76 MM	1
172-160		HARRINGTON BLADE	143 X 63 MM	1
172-150		GELPI BLADE SHARP		1

# ELCON 172











RING RETRAKTOR  
RING RETRACTOR  
ANNEAU RÉTRACTEUR  
ANILLO RETRACTOR

RETRAKTOR SYSTEM FÜR DIE ALLGEMEINE CHIRURGIE / CLASSIC  
RETRACTOR SYSTEM FOR GENERAL SURGERY / CLASSIC  
SYSTÈME DE RÉTRACTION POUR LA CHIRURGIE GÉNÉRALE / CLASSIC  
SISTEMA RETRACTOR PARA CIRUGÍA GENERAL / CLASSIC









		description	dimensions	qty.
172-030		TABLE POST	365 MM, Ø 25 MM	1
172-033		POST COUPLING	FOR Ø 25 MM	1
172-032		HORIZONTAL FLEX BAR 360° ROTATABLE	Ø 25 MM	1
172-073		SEGMENTED RING	495 X 265 MM	1
172-086		CONTINUUM STRAIGHT SEGMENT pair	100 MM	1
172-035		TWISTER RATCHET		1

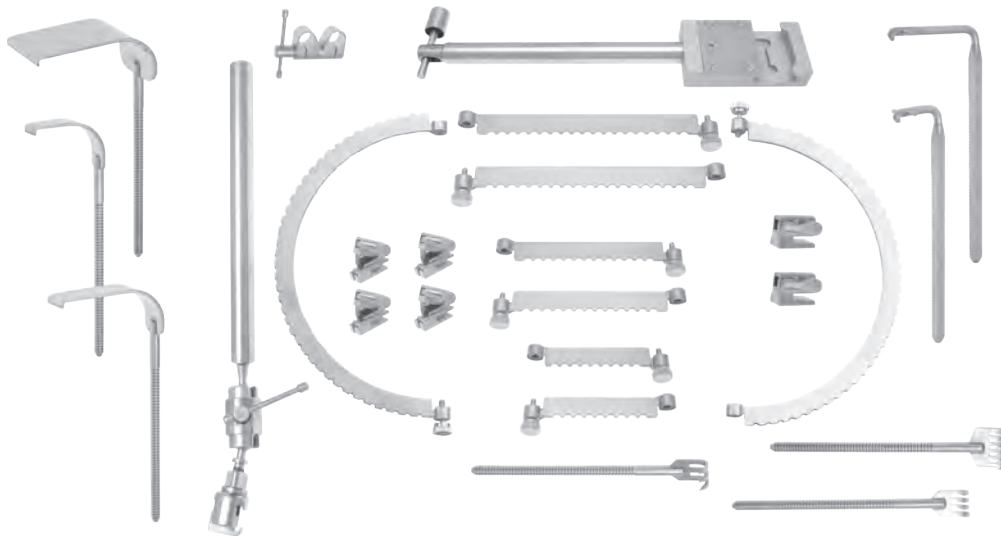











		description	dimensions	qty.
172-037-1		TILT RATCHET ROTATABLE WITH RING FIXATION		4
172-036		TILT RATCHET		4
172-142		KELLY BLADE	76 X 51 MM	2
172-144		KELLY BLADE	102 X 51 MM	2
172-146		KELLY BLADE	127 X 51 MM	1
172-148		KELLY BLADE	152 X 51 MM	1
172-110		MALLEABLE BLADE with protective end	152 X 35 MM	1
172-111		MALLEABLE BLADE with protective end	152 X 51 MM	2
172-112		MALLEABLE BLADE with protective end	152 X 76 MM	1
172-120		BALFOUR BLADE	67 X 76 MM	1
172-160		HARRINGTON BLADE	143 X 63 MM	1

RETRAKTORSYSTEM FÜR DIE WIRBELSÄULENCHIRURGIE  
RETRACTOR SYSTEM FOR SPINAL SURGERY  
SYSTÈME DE RÉTRACTION POUR LA CHIRURGIE DE LA COLONNE VERTÉBRALE  
SISTEMA RETRACTOR PARA CIRUGÍA DE LA COLUMNA VERTEBRAL

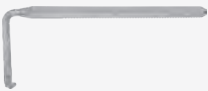







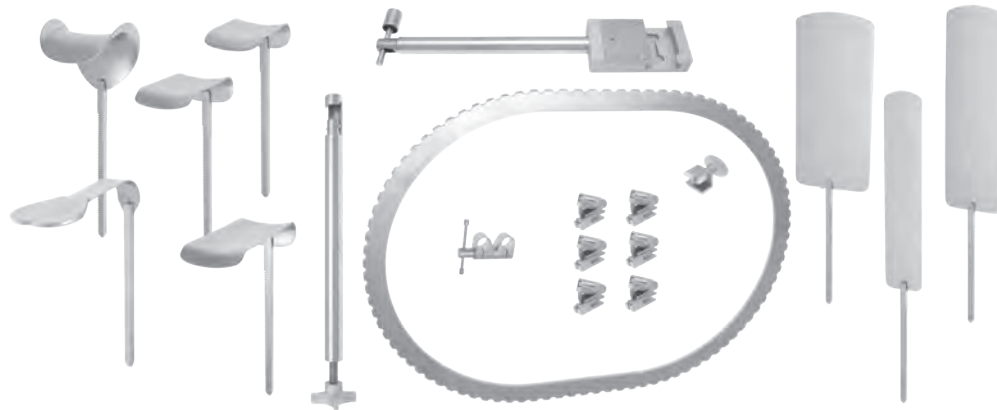







		description	dimensions	qty.
172-030		TABLE POST	365 MM, Ø 25 MM	1
172-032		HORIZONTAL FLEX BAR 360° ROTATABLE	Ø 25 MM	1
172-033		POST COUPLING	FOR Ø 25 MM	1
172-085		CONTINUUM SEGMENTED RING	Ø 216 MM	1
172-086		CONTINUUM STRAIGHT SEGMENT pair	100 MM	1
172-087		CONTINUUM STRAIGHT SEGMENT pair	150 MM	1

		description	dimensions	qty.
172-088		CONTINUUM STRAIGHT SEGMENT pair	200 MM	1
172-034		RATCHET		6
172-036		TILT RATCHET		4
172-151		MEYERDING BLADE	17 X 60 MM	2
172-152		MEYERDING BLADE	25 X 85 MM	2
172-153		MEYERDING BLADE	50 X 95 MM	2
172-156		SCOVILLE HOOK	50 MM	2
172-157		SCOVILLE HOOK	83 MM	2
172-183		RAKE RETRACTOR, SHARP	3 PRONGS	2
172-184		RAKE RETRACTOR, SHARP	4 PRONGS	2
172-186		RAKE RETRACTOR, SHARP	6 PRONGS	2

RETRAKTOR SYSTEM FÜR DIE BARIATRISCHE CHIRURGIE  
RETRACTOR SYSTEM FOR BARIATRIC SURGERY  
SYSTÈME DE RÉTRACTION POUR LA CHIRURGIE BARIATRIQUE  
SISTEMA RETRACTOR PARA CIRUGÍA BARIÁTRICA

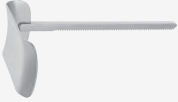

		description	dimensions	qty.
172-030-1		TABLE POST	450 MM, Ø 25 MM	1
172-031		HORIZONTAL BAR	365 MM Ø 25 MM	1
172-033		POST COUPLING	FOR Ø 25 MM	1
172-051		OVAL RING	368 X 267 MM	1
172-036		TILT RATCHET		6
172-035		TWISTER RATCHET		1



		description	dimensions	qty.
172-034-1		RATCHET EXTENSION		1
172-105		SPATULA MALLEABLE	254 X 51 MM	1
172-107		SPATULA MALLEABLE	254 X 76 MM	1
172-108		SPATULA MALLEABLE	203 X 102 MM	1
172-142		KELLY BLADE	76 X 51 MM	1
172-144		KELLY BLADE	102 X 51 MM	1
172-148		KELLY BLADE	152 X 51 MM	1
172-161		HARRINGTON BLADE	254 x 89 MM	1
172-120		BALFOUR BLADE	67 X 76 MM	1

# ELCON 172



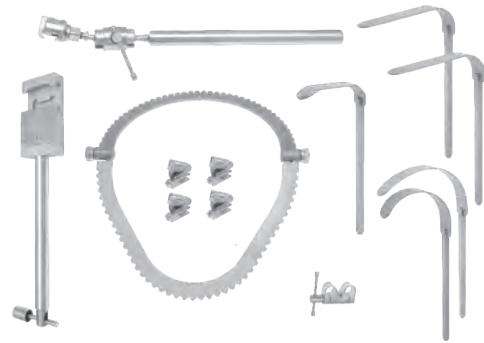

RING RETRAKTOR  
RING RETRACTOR  
ANNEAU RÉTRACTEUR  
ANILLO RETRACTOR

RETRAKTOR SYSTEM FÜR DIE GYNÄKOLOGISCHE CHIRURGIE  
RETRACTOR SYSTEM FOR GYNECOLOGY SURGERY  
SYSTÈME DE RÉTRACTION POUR LA CHIRURGIE GYNÉCOLOGIQUE  
SISTEMA RETRACTOR PARA CIRUGÍA GINECOLÓGICA





		description	dimensions	qty.
172-030		TABLE POST	365 MM, Ø 25 MM	1
172-032		HORIZONTAL FLEX BAR 360° ROTATABLE	Ø 25 MM	1
172-033		POST COUPLING	FOR Ø 25 MM	1
172-065		SEGMENTED RING	265 X 200 MM	1
172-037		TILT RATCHET WITH RING FIXATION		4
172-230		VAGINAL BLADE lateral	76 X 25 MM	2
172-234		VAGINAL BLADE posterior	114 X 25 MM	1
172-242		DEAVER BLADE vaginal	89 X 25 MM	1
172-243		DEAVER BLADE vaginal	127 X 25 MM	1

ERWEITERUNGSMODUL FÜR KLEINE EINGRIFFE  
EXTENSION MODULE FOR MINOR SURGERY  
MODULE D'EXTENSION POUR LA CHIRURGIE PETITE  
MÓDULO DE EXTENSIÓN PARA CIRUGIA MENOR

		description	dimensions	qty.
172-055		ROUND RING	Ø 216 MM	1
172-134		KELLY BLADE	38 X 25 MM	1
172-135		KELLY BLADE	63 X 25 MM	1
172-150		GELPI BLADE SHARP		1

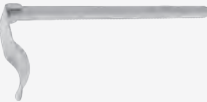
ERWEITERUNGSMODUL FÜR REKTALE EINGRIFFE  
EXTENSION MODULE FOR RECTAL SURGERY  
MODULE D'EXTENSION POUR LA CHIRURGIE RECTALE  
MÓDULO DE EXTENSIÓN PARA CIRUGIA RECTAL

		description	dimensions	qty.
172-055		ROUND RING	Ø 216 MM	1
172-220		RECTAL BLADE	70 X 22 MM	2
172-222		RECTAL BLADE	100 X 22 MM	2

## TABLE POSTS AND HORIZONTAL BARS



TABLE POST		Ø	length	item no.
		25 mm	365 mm	<b>172-030*</b>
		25 mm	450 mm	<b>172-030-1</b>
	 post holder only	25 mm		<b>172-030-2</b>



HORIZONTAL BAR		Ø	length	item no.
		25 mm	365 mm	<b>172-031</b>



HORIZONTAL FLEX BAR / 360° ROTATABLE		Ø	length	item no.
		25 mm		<b>172-032</b>



TABLE POST		Ø	length	item no.
		25 mm	365 mm	<b>172-038*</b>
		25 mm	450 mm	<b>172-038-1</b>



POST COUPLING		Ø	length	item no.
		25 mm		<b>172-033</b>

\* shown item





RATCHET EXTENSION	item no.
	<b>172-034-1</b>

STANDARD RATCHET	item no.
	<b>172-034</b>



TILT RATCHET	item no.
	<b>172-036</b>



TILT RATCHET WITH RING FIXATION	item no.
	<b>172-037</b>



TILT RATCHET ROTATABLE WITH RING FIXATION	item no.
	<b>172-037-1</b>



TWISTER RATCHET	item no.
	<b>172-035</b>



## RETRACTION RINGS



OVAL RINGS	item no.
311 x 203 mm, 12 1/4" x 8"	<b>172-050</b>
368 x 267 mm, 14 1/2" x 10 1/2"	<b>172-051</b>
470 x 305 mm, 18 1/2" x 12"	<b>172-052</b>



ROUND RINGS	item no.
Ø 216 mm, 8 1/2"	<b>172-055</b>
Ø 265 mm, 10 1/2"	<b>172-060</b>
Ø 315 mm, 12 1/2"	<b>172-061</b>



SEGMENTED RINGS	item no.
356 x 216 mm, 14" x 8 1/2"	<b>172-071</b>
495 x 265 mm, 19 1/2" x 10 1/2"	<b>172-073</b>
495 x 315 mm, 19 1/2" x 12 1/2"	<b>172-075</b>



SEGMENTED ROUND RINGS	item no.
Ø 216 mm, 8 1/2" pair	<b>172-085</b>
Ø 265 mm, 10 1/2" pair	<b>172-084</b>



SEGMENTED EXTENSION FOR RINGS	item no.
100 mm	<b>172-086</b>
150 mm	<b>172-087</b>
200 mm	<b>172-088</b>

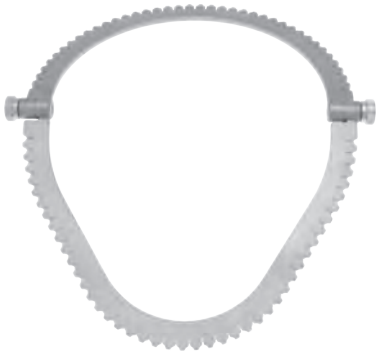

SEGMENTED RING	item no.
265 x 200 mm, 10 1/2" x 8"	<b>172-065</b>

**BLADES**

MALLEABLE BLADE	item no.
152 x 35 mm	<b>172-102</b>
152 x 51 mm	<b>172-104</b>
254 x 51 mm	<b>172-105</b>
152 x 76 mm	<b>172-106</b>
254 x 76 mm	<b>172-107</b>
203 x 102 mm	<b>172-108</b>



MALLEABLE BLAD with protective end	item no.
152 x 35 mm	<b>172-110</b>
152 x 51 mm	<b>172-111</b>
152 x 76 mm	<b>172-112</b>
102 x 25 mm	<b>172-113</b>



BALFOUR BLADE	item no.
67 X 76 mm	<b>172-120</b>
89 X 70 mm	<b>172-121</b>



KELLY BLADE	item no.
64 x 51 mm	<b>172-130</b>
38 x 25 mm	<b>172-134</b>
63 x 25 mm	<b>172-135</b>
38 x 51 mm	<b>172-140</b>
76 x 51 mm	<b>172-142</b>
102 x 51 mm	<b>172-144</b>
127 x 51 mm	<b>172-146</b>
152 x 51 mm	<b>172-148</b>



GELPI BLADE	item no.
sharp	<b>172-150</b>



MEYERDING BLADE	item no.
17 x 60 mm	<b>172-151</b>
25 x 85 mm	<b>172-152</b>
50 x 95 mm	<b>172-153</b>

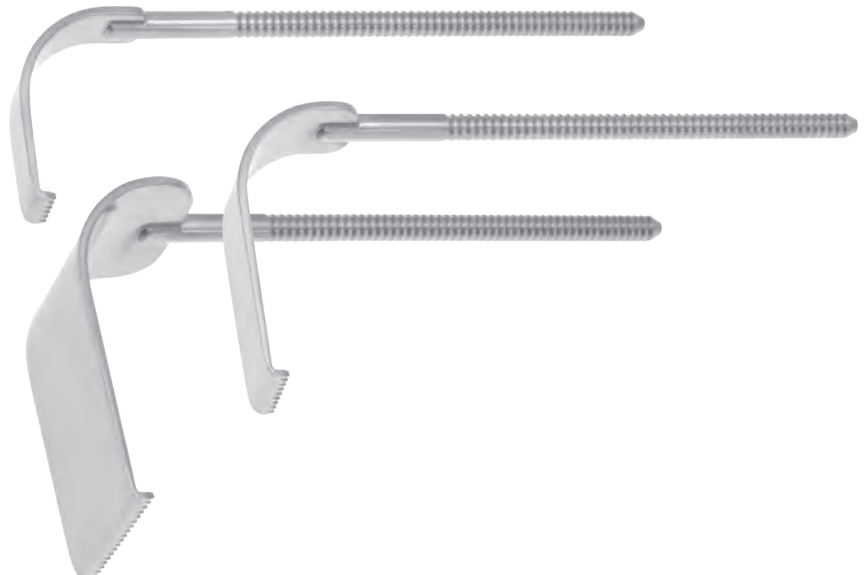

SCOVILLE HOOK	item no.
50 mm	<b>172-156</b>
83 mm	<b>172-157</b>



HARRINGTON BLADE	item no.
146 x 38 mm	<b>172-160</b>
254 x 89 mm	<b>172-161</b>



RICHARDSON BLADE	item no.
25 x 19 mm	<b>172-170</b>
51 x 19 mm	<b>172-171</b>
32 x 25 mm	<b>172-172</b>



RAKE BLADE	item no.
19 x 17 mm (3 prong)	<b>172-183</b>
9 x 19 mm (4 prong)	<b>172-184</b>
9 x 29 mm (6 prong)	<b>172-186</b>

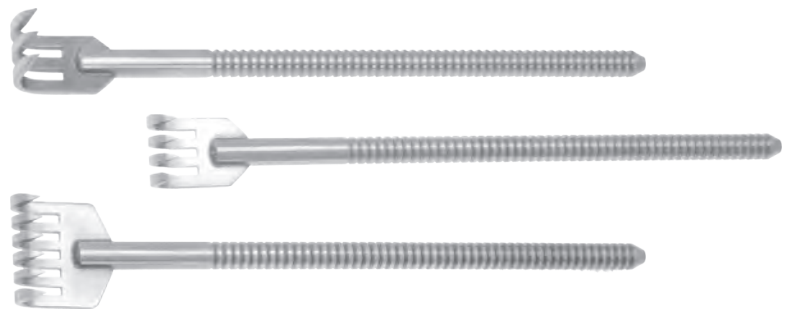

RECTAL BLADE	item no.
70 x 22 mm	<b>172-220</b>
100 x 22 mm	<b>172-222</b>



# ELCON 172

RING RETRAKTOR  
RING RETRACTOR  
ANNEAU RÉTRACTEUR  
ANILLO RETRACTOR

VAGINAL BLADE lateral	item no.
76 x 25 mm	<b>172-230</b>



VAGINAL BLADE posterior	item no.
114 x 25 mm	<b>172-234</b>



DEAVER BLADE vaginal	item no.
89 x 25 mm	<b>172-242</b>
127 x 25 mm	<b>172-243</b>



IMA RETRACTOR	item no.
RATCHET	<b>172-251</b>
HORIZONTAL BAR 300 mm	<b>172-250</b>
IMA BLADE (4 prong)	<b>172-252</b>

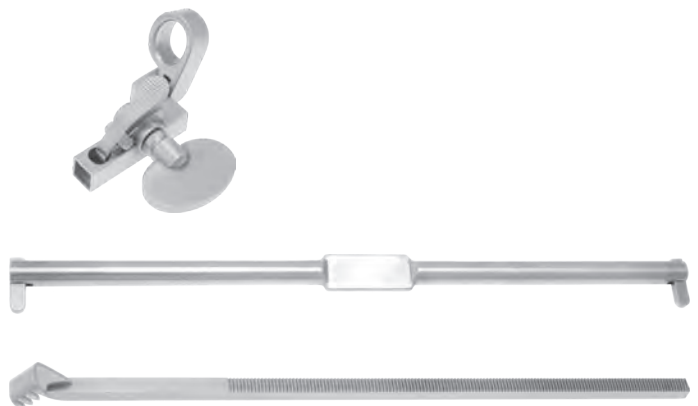



# **ELCON**

*MEDICAL INSTRUMENTS GmbH*

D - 78532 Tuttlingen  
Tel: +49 7461 9281-0  
info@elcon-medical.de

Dr. Karl-Storz-Str. 26  
Fax: +49 7461 9281-29  
www.elcon-medical.com