

KNOCHEN - CHIRURGIE
BONE SURGERY
CIRURGIA ORTOPEDICA
CHIRURGIE OSSEUSE

ELCON
MEDICAL INSTRUMENTS GmbH

390 - 419

**KNOCHEN - CHIRURGIE
BONE SURGERY
CIRURGIA ORTOPEDICA
CHIRURGIE OSSEUSE**



Grau dargestellte Artikelnummern bezeichnen „distributed by ELCON“ Produkte
Article numbers shown in grey indicate „distributed by ELCON“ products
Los numeros de articulos mostrados en gris indican productos „distribuidos por ELCON“
Les numéros d'articles affichés en gris indiquent les produits « distribués par ELCON »

ELCON

A

ADSON	
- cranial rongeur	76
- periosteal elevator	24-26
ALDERDYCE	
- dissector	15
ALEXANDER	
- chisel	55
- gouge	55
ALEXANDER-FARABEUF	
- rib raspatory	37
Amputation retractors	2
Amputation saws	2
Antrum raspatories	42
AUFRANC-COBRA	
- bone lever	23
AUFRICHT	
- nasal rasp	41

B

BACON	
- cranial rongeur	76
BAILEY-DEMARTEL	
- saw guide	4
Bandage scissors	9-12
BARTH	
- bone curette, double-ended	44
BEESON	
- cast breaker	13
BENNET	
- bone lever	23
BERGMANN	
- bandage scissor	9
BERRY	
- tungstengrip wire twister	91
BEYER	
- bone rongeur	74, 77
BIER	
- amputation saw	2
- saw blade	2
BLOUNT	
- bone lever	22
BLUMENTHAL	
- bone rongeur	74
BOEHLER	
- bone cutting forceps	83
- bone rongeur	77
- traction bows	92
Bone clamps	72
Bone curettes	45-50
- double-ended	43-45
Bone cutting forceps	82-86
Bone elevator	17
Bone files	38-41
Bone flap elevators	15
Bone holding forceps	64-72
Bone levers	17-23
Bone rasps	38-40
Bone rongeurs	73-81
Bone wire	90
BRAND	
- tendon holding forceps	86
BRISTOW	
- bone lever	22
BRUNS	
- bandage scissor	10
- bone curette	45, 47
- plaster scissor	11
BUCK-GRAMCKO	
- bone lever	17
BUCKLEY	
- gouge	56

- osteotome	56
BUECHS	
- raspatory	32
BUNNEL	
- hand drill	88

C

CAIRNS	
- bone flap elevator	15
CARROLL	
- osteotome	56
- tendon seizing forceps	86
Cartilage Clamps	64
CASPAR	
- bone curette	48
Cast Breakers	13
CHARRIERE	
- amputation saw	3
- saw blade	3
Chisels	54-56,
58, 61	
CLEVELAND	
- bone cutting forceps	82
- bone rongeur	76
COBB	
- spinal elevator	34
- spinal gouge	62
Combi flat nose pliers	94
Compression	
- bandage	1
- tube	1
Comprimeter	1
CORWIN	
- wire twisting forceps with tungstengrip	91
COTTLE	
- elevator	29
- nasal rasp	41
- osteotome	57
COTTLE-MC KENTY	
- elevator	29
Cranial rongeurs	76
Cuff	
- for the arm	1
- for the leg	1
- for children	1
CUSHING	
- elevator	25
- raspatory	24-26

D

DEMEL	
- wire guide	90
- wire tightening forceps	90
DINGMANN	
- cartilage clamp	64
Dissectors	15
DOYEN	
- mallet	50
- rib raspatory	36
Drill handles	87
Drills	88

E

EAST GRINSTEAD	
- chisel	56
- osteotome	56
ECHLIN	
- bone rongeur	80
Electric plaster saw	6-8

Elevators	14-17,	HEY-GROVES	
25,	27-29	- bone holding forceps	69
Elevator, spinal	36	HILL	
ENGEL		- elevator	29
- plaster saw	5	HOEN	
ESMARCH		- elevator	25
- bandage scissor	9	HOHMANN	
- compression bandage	1	- bone lever	17, 19-22
- plaster knife	5	HOPKINS	
EXCENTRIC		- plaster knife	5
- bandage scissor	9	HOUSE	
Extracting forceps	94	- bone curettes, double-ended	43
		HOWARTH	
		- elevator	28
F			
FARABEUF		I	
- bone holding forceps	68	Interlacing forceps	86
- raspatory	32		
FARABEUF-COLLIN			
- raspatory	32	J	
FARABEUF-LAMBOTTE		JACOBSON	
- bone holding forceps	68	- bone curettes, double-ended	44
FERGUSON		JANSEN	
- bone holding forceps	65	- bone curettes, double-ended	44
Finger nail instruments		- bone rongeur	74
- compression	98	- raspatory	31
- extracting forceps	98	JOSEPH	
- ring saw	98	- nasal rasp	42
- splitting forceps	98	- raspatory	30
Flat nose pliers	94-95		
FOMON with Tungstengrip		K	
- bone rasp	40	KAZANJIAN	
FOMON (KLEINERT KUTZ)		- bone cutting forceps	82
- bone rasp	39	KERN	
FOMON-MASING		- bone holding forceps	67
- bone rasp	39	KEY	
Forceps		- periosteal raspatory	33
- bone holding	64-72	KILLIAN	
- reposition	63-65	- elevator	28
FREER		- gouge	54
- chisel	54	KILLIAN-CLAUS	
- elevator	28	- gouge	54
- gouge	54	KIRSCHNER	
FREER-YASARGIL		- extension bow	92
- elevator	28	- wire	93
FRIEDMANN		KOENIG	
- bone rongeur	73	- elevator	14, 24
G			
GERSTER		L	
- traction bar	72	LAHEY	
GIGLI		- bone holding forceps	66
- saw handle	4	LAMBOTTE	
- wire saw	4	- osteotome	57
Glabella rasps	41-43	- raspatory	32
Gouges	54-56,	LANDOLT	
	58-62	- raspatory	29
		LANE	
		- bone holding forceps	67
H		- bone lever	22
HALLE		LANE-THRETHOWAN	
- elevator	27	- bone lever	22
Hammer	50-54	LANGE-HOHMANN	
Hand drills	88	- bone lever	18
Handles for drill	87	LANGENBECK	
HARTMANN		- bone holding forceps	65
- bone rongeur	74	- elevator	16
HEATH		- finger saw	3
- mallet	51	- raspatory	31
HENNING		LEKSELL	
- cast breaker	13		

- bone rongeur	80	- osteotome	60
LEMPERT		MITCHELLS	
- bone rongeur	75	- raspatory	32
- elevator	30	MOLT	
- raspatory	27	- periosteal elevator	29
LEWIN		MURPHY-LANE	
- bone holding forceps	64	- bone lever	23
LEWIS			
- septum raspatory	42		
LEXER		N	
- gouge	60	Nail extracting forceps	98
- osteotome	60-62	Nail splitting forceps	98
- spongiosa gouge	61	Nasal rasps	41-43
LISTER EXCENTRIC		NORTHFIELD	
- bandage scissor	9, 11	- bone rongeur	75
LISTON			
- bone cutting forceps	82, 84		
LITTAUER-LISTON		O	
- bone cutting forceps	82	OBWEGGESER- FREER	
LORENZ		- elevator	28
- bandage scissor	10	OLIVECRONA	
LOUTE		- bone rongeur	76
- wire twisting instrument	90	- wire saw	4
LOVE-ADSON		OMBREDANNE	
- elevator	24	- hammer	51
LOWMAN		Osteotomes	54-62
- bone clamp	72		
LOWMAN-HOGLUND			
- bone clamp	72	P	
LUCAE		PARTSCH	
- mallet	50	- chisel	55
LUCAS		- gouge	55
- chisel	56	- mallet	51
- gouge	56	- raspatory	26
LUER		PENNYBAKER	
- bone rongeur	73, 75	- raspatory	25
		PERCY	
M		- amputation retractor	2
Mallets	50-54	Periosteal elevators	24, 26, 29-31, 35
MALTZ		Periosteal raspatories	25-31, 33
- nasal rasp	41	PERTHES	
MARQUART		- reamer	87
- bone rongeur	77	PHILIPS	
MARTIN		- screw driver	89
- plaster knife	5	Plaster breakers	12
MATSON		plaster knives and saw	5
- rib raspatory	37	Plaster scissors	9-12
MAYFIELD		Plaster shears	10, 12
- bone rongeur	77	Plaster spreaders	13
MC DONALD		PLESTER	
- dissector	15	- raspatory	26
MC INDOE		Pump with manometer	1
- bone cutting forceps	83	PUTTI	
MC KISSOCK		- bone rasp	38
- raspatory	31		
MEAD		Q	
- bone rongeur	75	QUERVAIN	
- mallet	50	- elevator	16
- periosteal elevator	29		
MEYER			
- reposition forceps	63	R	
Micro elevators	14	RADOLF	
MILLER		- nail extracting forceps	98
- bone rasp	39	RALK	
MINI FRIEDMANN		- hand drill	88
- bone rongeur	73	Raspatories	24-28, 29-36
MINI-LAMBOTTE		Reamer	87
- osteotome	57	REILL	
MINI-LANGENBECK		- reposition forceps	63
- elevator	16	Reposition forceps	63-65
MINI-LEXER			
- gouge	60		

Resection saw	3
Rib raspatories	36-38
ROETTGEN-RUSKIN	
- bone rongeur	78
ROSE	
- raspatory	26
ROWLAND	
- bone cutting rongeur	83
RUBIO	
- wire twisting forceps with tungstengrip	91
RUSKIN	
- bone rongeur	78
RUSKIN-LISTON	
- bone cutting rongeur	83
RUSKIN-STILLE	
- bone rongeur	78

S

SATTERLEE	
- amputation saw	3
- saw blade	3
SAUERBRUCH	
- bone rongeur	81
Saw	2-7
Saw blades for electric saw	8
Saw guides	4
SCHEDE	
- bone curette	46
SCHNEIDER	
- raspatory	31
SCHNEIDER-SAUERBRUCH	
- raspatory	31
SCOVILLE	
- bone curette	49
Screw driver	89
SEBILEAU	
- elevator	14
SEDILLOT	
- raspatory	31
SEMB	
- bone cutting forceps	85
- bone holding forceps	66
- bone rongeur	79
- raspatory	37
Septum raspatory	42
Sequestrum forceps	65
SEUTIN	
- bandage scissor	10
SEWALL	
- raspatory	27
SHEEHAN	
- osteotome	54
SIMON	
- bone curette	46
SMITH-PETERSON	
- gouge	59
- osteotome	59
Spinal curettes	47
Spinal elevators	34
Spinal gouges	62
Spongiosa gouges	61
SPINAL	
- bone curette	47
SPRATT	
- bone curette	46
ST. CLAIR THOMPSON	
- raspatory	27
Steel wire	90
STEINMANN	
- pin	92
STELLBRINK	
- synovectomy rongeur	73

STILLE	
- bone rongeur	80
- chisel	58
- gouge	58
- osteotome	58
- plaster shear	12
STILLE-HORSLEY	
- bone cutting forceps	85
STILLE LUER	
- bone rongeur	79
STOOKEY	
- cranial rongeur	76
Synovectomy rongeurs	73

T

Tampers	54
Tendon holding forceps	86
Traction bar	72
Traction bows	
- for the arm	92
- for the leg	92
- for thigh and knee	92
TUDOR EDWARDS	
- bone cutting forceps	85
Tungstencut	
- bandage scissors	11
- wire cutting pliers	96-98
- wire cutting scissors	11
Tungstengrip	
- bone rasp	40
- flat nose pliers	94
- wire twister	91, 94

U

Universal wire cutting scissor	11
ULRICH	
- bone holding forceps	69
USA	
- plaster spreader	13

V

VAN BUREN	
- bone holding forceps	65
VERBRUGGE	
- bone holding forceps	70
- bone lever	20
VICKERS	
- mallet	50
VOLKMANN	
- bone curettes	45
- bone curettes, double-ended	43-45

W

WAGNER	
- bone lever	19
WARD	
- periosteal elevator	26
WATSON-CHEYNE	
- dissector	15
- elevator	15
WATSON-JONES	
- bone lever	22
WIENER	
- nasal rasp	42
WILLIGER	
- bone curettes	46
- bone curettes, double-ended	43
- elevator	14, 24

- mallet	51
Wire cutting pliers	94,
96-98	
Wire cutting scissors	11
Wire dispenser	93
Wire guides	90
Wire saw	6
Wire tightener	90
Wire twister	91
Wires	
- double trocar point	93
- trocar point / round shaft	93
- trocar point / flat shaft	93
WOLF-BOEHLER	
- plaster breaker	12
Wrench	8

Z

ZAUFAL-JANSEN	
- bone rongeur	77

120		340-914	24	390-500	4	410-144	34	410-330-14	32
121-099	11	340-915	24	390-501	4	410-145	34	410-330-16	32
121-905	11	340-929	25	390-512-30	4	410-146	34	410-331-04	32
121-917	11	340-935	25	390-512-40	4	410-147	34	410-331-06	32
124-225	10	340-950	25	390-512-50	4	410-148	34	410-331-08	32
124-227	9	340-951	25	390-512-60	4	410-149	34	410-331-10	32
124-251	9	340-952	25	390-512-70	4	410-151	33	410-331-12	32
124-253	9	340-954	24	390-514-30	4	410-152	33	410-331-16	32
124-261	9	340-960	25	390-514-40	4	410-153	33	410-336	32
124-305	10	340-961	25	390-514-50	4	410-155	33	410-337	32
124-321	9	340-962	25	390-514-60	4	410-156	33	410-340	31
124-323	9	340-963	25	390-514-70	4	410-160	15	410-342	31
124-331	10	340-966	24			410-165	15	410-345	31
124-333	10	341-620	47	400		410-196	23	410-346	31
		341-621	47	400-201	12	410-200	18	410-350	32
		341-622	47	400-203	12	410-202	18	410-351	32
180		341-623	47	400-211	12	410-204	18	410-352	32
180-450	15	341-624	47	400-300	5	410-206	19	410-353	32
180-451	15	341-625	47	400-310	5	410-210	21	410-354	32
		341-626	47	400-331	5	410-219	19	410-359	22
200		341-627	47	400-410	5	410-220	19	410-360	22
200-900	91	341-628	47	400-500	12	410-222	19	410-368	26
200-902	91	341-630	47	400-502	12	410-228	19	410-369	26
200-904	91	341-631	47	400-515	13	410-230	20	410-380	35
200-906	91	341-632	47	400-520	13	410-231	20	410-381	35
200-908	91	341-633	47	400-530	13	410-240	20	410-382	35
200-910	91	341-634	47			410-241	20	410-383	35
200-912	91	341-635	47	410		410-244	21	410-384	35
200-914	91	341-636	47	410-090	14	410-246	21	410-388	35
200-922	91	341-637	47	410-092	14	410-251	22	410-393-01	27
200-926	91	341-638	47	410-100	17	410-253	22	410-393-02	27
		341-680	49	410-102	17	410-254	22	410-395	31
		341-681	49	410-104	17	410-256	22	410-400	38
250		341-683	49	410-104	17	410-262	22	410-402	39
250-900	66	343-711	76	410-105	17	410-265	23	410-410	38
250-901	66	343-711	76	410-106	17	410-270	23	410-411	38
251-002-20	81	343-713	76	410-107	17	410-271	23	410-420	38
251-002-20	81	343-713	76	410-108	17	410-285	23	410-430	39
251-004-20	81	343-714	76	410-109	17	410-285	35	410-431	39
251-004-20	81	343-714	76	410-112	14	410-286	23	410-432	39
251-100	37	343-781	80	410-114	14	410-287	23	410-450	46
251-101	37	343-783	80	410-116	14	410-287	35	410-451	46
251-102	37	343-785	79	410-117	14	410-300	24	410-452	46
251-104	37			410-119	14	410-302	24	410-453	46
251-105	37	390		410-120	14	410-306	24	410-460	44
251-107	37	390-100	1	410-121	15	410-3081	27	410-462	44
251-122	37	390-105	1	410-122	16	410-3082	27	410-476	43
251-132	36	390-122	1	410-124	16	410-3083	27	410-477	43
251-133	36	390-300	2	410-126	16	410-3084	27	410-478	43
251-134	36	390-302	2	410-128	16	410-313	29	410-480	43
251-135	36	390-400	3	410-1291	16	410-315	26	410-481	43
251-136	36	390-410	3	410-1292	16	410-318	32	410-482	43
251-136	36	390-411	3	410-1293	16	410-320	32	410-485	44
251-137	36	390-420	3	410-1294	16	410-324	31	410-486	44
251-140	37	390-421	3	410-130	16	410-325	31	410-487	44
		390-430	3	410-132	16	410-327	31	410-490	43
		390-431	3	410-134	16	410-330-04	32	410-492	43
340		390-432	3	410-134	16	410-330-06	32	410-494	43
340-835	4	390-440	2	410-140	34	410-330-08	32	410-496	44
340-910	25	390-441	2	410-141	34	410-330-10	32	410-498	44
340-912	24	390-442	2	410-142	34	410-330-12	32	410-510	45
340-913	24	390-443	2	410-143	34				

NUMERISCHER INDEX
 NUMERIC INDEX
 ÍNDICE NUMÉRO
 INDEX NUMERIQUE



410-511	45	410-5772	45	410-824	58	411-033	60	411-224	57
410-512	45	410-5773	45	410-826	58	411-034	60	411-225	57
410-513	45	410-5774	45	410-828	58	411-035	60	411-226	57
410-514	45	410-5775	45	410-836	58	411-050	61	411-227	57
410-515	45	410-5776	45	410-838	58	411-051	61	411-228	57
410-516	45	410-5786	45	410-840	58	411-052	61	411-229	57
410-517	45	410-583	49	410-842	58	411-053	61	411-230	57
410-518	45	410-584	49	410-844	58	411-054	61	411-231	57
410-519	45	410-585	49	410-846	58	411-055	61	411-232	57
410-520	47	410-586	49	410-848	58	411-080	62	411-240	57
410-521	47	410-593	49	410-900	55	411-081	62	411-241	57
410-522	47	410-594	49	410-901	55	411-082	62	411-242	57
410-523	47	410-595	49	410-902	55	411-083	62	411-243	57
410-524	47	410-596	49	410-903	55	411-160-06	59	411-244	57
410-525	47	410-604	51	410-904	55	411-160-09	59	411-245	57
410-526	47	410-606	51	410-910	55	411-160-13	59	411-246	57
410-527	47	410-607	51	410-911	55	411-160-16	59	411-247	57
410-528	47	410-608	51	410-912	55	411-160-19	59	411-248	57
410-530	47	410-613	51	410-913	55	411-160-25	59	411-249	57
410-531	47	410-614	51	410-914	55	411-160-32	59	411-250	57
410-532	47	410-616	51	410-930	55	411-161-06	59	411-251	57
410-533	47	410-618	50	410-931	55	411-161-09	59	411-252	57
410-534	47	410-620	50	410-932	55	411-161-13	59	411-2602	56
410-535	47	410-621	50	410-933	55	411-161-16	59	411-2603	56
410-536	47	410-623	50	410-934	55	411-161-19	59	411-2604	56
410-537	47	410-624	50	410-940	55	411-161-25	59	411-2612	56
410-538	47	410-625	50	410-941	55	411-161-32	59	411-2613	56
410-540	45	410-626	50	410-942	55	411-162-06	59	411-2614	56
410-541	45	410-628	50	410-943	55	411-162-09	59	411-2620	61
410-542	45	410-629	50	410-944	55	411-162-13	59	411-2621	61
410-543	45	410-632	52	410-960	55	411-162-16	59	411-2622	61
410-544	45	410-634	52	410-961	55	411-162-19	59	411-2623	61
410-545	45	410-636	52	410-962	55	411-162-25	59	411-2624	61
410-546	45	410-637	52	410-963	55	411-162-32	59	411-2625	61
410-547	45	410-646	52	410-964	55	411-163-06	59	411-2626	61
410-548	45	410-648	53	410-965	55	411-163-09	59	411-2627	61
410-549	45	410-656	53	410-970	55	411-163-13	59	411-2628	61
410-560	46	410-660	51	410-971	55	411-163-16	59	411-2629	61
410-561	46	410-682	54	410-972	55	411-163-19	59	411-300	65
410-562	46	410-683	54	410-973	55	411-163-25	59	411-301	65
410-563	46	410-684	54	410-974	55	411-163-32	59	411-303	63
410-564	46	410-685	54	410-975	55	411-200	57	411-3046	63
410-565	46	410-686	54	411-000	60	411-201	57	411-305	65
410-566	46	410-688	54	411-001	60	411-202	57	411-307	63
410-5710	46	410-689	54	411-002	60	411-203	57	411-308	63
410-5711	46	410-690	54	411-003	60	411-204	57	411-309	64
410-5712	46	410-720-04	56	411-004	60	411-205	57	411-310	64
410-5713	46	410-720-06	56	411-010	60	411-206	57	411-313	63
410-5740	45	410-722-03	56	411-011	60	411-207	57	411-316	66
410-5741	45	410-722-05	56	411-012	60	411-210	57	411-317	66
410-5742	45	410-796	58	411-013	60	411-211	57	411-318	66
410-5743	45	410-798	58	411-014	60	411-212	57	411-319	64
410-5744	45	410-800	58	411-020	60	411-213	57	411-320	65
410-5745	45	410-802	58	411-021	60	411-214	57	411-322	65
410-5746	45	410-804	58	411-022	60	411-215	57	411-324	65
410-5747	45	410-806	58	411-023	60	411-216	57	411-330	64
410-5748	45	410-808	58	411-024	60	411-217	57	411-340	68
410-5749	45	410-816	58	411-025	60	411-220	57	411-341	68
410-5769	45	410-818	58	411-030	60	411-221	57	411-342	68
410-5770	45	410-820	58	411-031	60	411-222	57	411-345	69
410-5771	45	410-822	58	411-032	60	411-223	57	411-346	69

411-347	69	411-577	73	411-833	84	413-172	94	419-0140	93
411-350	67	411-583	75	411-840	85	413-173	94	419-0142	93
411-351	67	411-589	75	411-850	85	413-174	94	419-0144	93
411-352	67	411-593	76	412-006	98	413-177	94	419-0145	93
411-353	67	411-595	76	412-010	98	413-178	94	419-0146	93
411-356	67	411-600	77	412-033	98	413-179	94	419-0148	93
411-357	67	411-601	77	412-034	98	413-186	96	419-0150	93
411-370	70	411-602	77	412-090SS	98	413-192	96	419-0152	93
411-371	70	411-603	77	412-127	86	413-193-15	96	419-0155	93
411-372	70	411-605	77	412-158	86	413-193-18	96	419-0160	93
411-373	70	411-611	77	412-159	86	413-195	96	419-0308	93
411-375	71	411-613	77	412-180	86	413-198	97	419-0310	93
411-376	71	411-614	77	412-182	86	413-199	97	419-0312	93
411-377	71	411-615	77	412-412	87	413-202	97	419-0314	93
411-378	71	411-617	77	412-500	88	413-600	92	419-0315	93
411-379	71	411-619	77	412-510	88	413-601	92	419-0316	93
411-390	69	411-620	78	412-520	88	413-602	92	419-0318	93
411-391	69	411-620	78	412-538	87	413-650	92	419-0320	93
411-392	69	411-621	78	412-580	87	413-651	92	419-0322	93
411-392	69	411-624	78	412-581	87	413-661	92	419-0325	93
411-393	69	411-625	78	412-586	87	413-662	92	419-0330	93
411-394	69	411-625	78	412-588	87	413-663	92	419-1138	93
411-394	69	411-631	78	412-600	89	414-643	48	419-1140	93
411-395	69	411-632	78	412-601	89	414-643	48	419-1142	93
411-400	72	411-633	78	412-602	89	414-644	48	419-1144	93
411-401	72	411-641-03	80	412-603	89	414-645	48	419-1145	93
411-402	72	411-641-05	80	412-604	89	414-653	48	419-1146	93
411-403	72	411-641-08	80	412-606	89	414-654	48	419-1148	93
411-411	72	411-645-03	80	412-608	89	414-655	48	419-1150	93
411-412	72	411-645-05	80	412-610	89	414-734	48	419-1152	93
411-450	72	411-645-08	80	413-002	90	414-735	48	419-1155	93
411-503	74	411-651	80	413-003	90	414-743	48	419-1160	93
411-505	73	411-660	79	413-004	90	414-743	48	419-1308	93
411-507	73	411-661	79	413-005	90	414-744	48	419-1310	93
411-509	73	411-670	79	413-006	90	414-744	48	419-1312	93
411-510	74	411-671	79	413-007	90	414-754	48	419-1314	93
411-511	74	411-672	79	413-008	90	414-755	48	419-1315	93
411-513	74	411-673	79	413-009	90	414-756	48	419-1316	93
411-520	75	411-681	79	413-010	90	416-0508	92	419-1318	93
411-521	75	411-700	82	413-012	90	416-0510	92	419-1320	93
411-522	75	411-701	82	413-015	90	416-0512	92	419-1322	93
411-523	75	411-702	82	413-062	90	416-0514	92	419-1325	93
411-527	74	411-703	82	413-065	90	416-0515	92	419-1330	93
411-529	74	411-704	82	413-072	90	416-0516	92	419-2038	93
411-535	76	411-705	82	413-100	90	416-0518	92	419-2040	93
411-539	73	411-706	82	413-120	90	416-0520	92	419-2042	93
411-541	73	411-707	82	413-130	95	416-0521	92	419-2044	93
411-543	73	411-710	82	413-134	95	416-0525	92	419-2045	93
411-546	75	411-749	82	413-135	95	416-0530	92	419-2046	93
411-547	75	411-751	82	413-140	96	419-0038	93	419-2048	93
411-548	75	411-800	83	413-146	96	419-0040	93	419-2050	93
411-549	75	411-801	83	413-150	94	419-0042	93	419-2052	93
411-553	75	411-810	83	413-152	94	419-0044	93	419-2055	93
411-567	74	411-811	83	413-153	94	419-0045	93	419-2060	93
411-565	74	411-820	83	413-154	94	419-0046	93	419-2138	93
411-569	74	411-821	83	413-158	95	419-0048	93	419-2140	93
411-570-01	73	411-822	83	413-160	95	419-0050	93	419-2142	93
411-570-02	73	411-823	83	413-161	95	419-0052	93	419-2144	93
411-570-03	73	411-829	84	413-165	95	419-0055	93	419-2145	93
411-570-04	73	411-830	84	413-170	94	419-0060	93	419-2146	93
411-575	73	411-831	84	413-171	94	419-0138	93	419-2148	93

NUMERISCHER INDEX
 NUMERIC INDEX
 ÍNDICE NUMÉRO
 INDEX NUMERIQUE



419-2150	93	440-532	56	450-510	41	04-MST-00023	7
419-2152	93	440-534	56	450-512	42	04-MST-00025	7
419-2155	93	440-536	56	450-513	42	04-MST-00027	7
419-2160	93	440-540	56	450-518	41	04-MST-00029	7
419-2208	93	440-542	56	450-519	41	04-MST-00030	7
419-2210	93	440-544	56	450-520	41		
419-2212	93	440-546	56	450-530	41		
419-2214	93	440-591	54	450-531	41		
419-2215	93	440-593	54	450-531	41		
419-2216	93	440-602	28	450-540	39		
419-2218	93	440-603	28	450-542	39		
419-2220	93	440-611	27	450-548	39		
419-2222	93	440-612	27	450-590	40		
419-2225	93	440-614	26	450-591	40		
419-2230	93	440-615	28	450-592	40		
419-2308	93	440-616	28	450-593	40		
419-2310	93	440-618	27	450-594	40		
419-2312	93	440-620	28	450-698	30		
419-2314	93	440-621	28	450-700	30		
419-2315	93	440-626	28	450-701	30		
419-2316	93	440-627	28	450-702	30		
419-2318	93	440-636	27	450-703	30		
419-2320	93	440-637	27	450-706	30		
419-2322	93	440-660	29	450-707	30		
419-2325	93	440-665	29	450-708	29		
419-2330	93	440-666	29	450-732	29		
419-5418-08	93	441-111	42	450-733	29		
419-5418-10	93	441-113	42	450-740	26		
419-5418-12	93	441-290	46	450-741	26		
419-5418-14	93	441-291	46	451-120	82		
419-5418-16	93	441-292	46	452-270	28		
419-5418-18	93	441-293	46	452-271	28		
419-5418-20	93	441-294	46	453-103	56		
419-5418-22	93	441-295	46	453-105	56		
419-5418-25	93	441-296	46	453-113	56		
419-5433-08	93	441-297	46	453-115	56		
419-5433-10	93						
419-5433-12	93	450		470			
419-5433-14	93	450-302	54	470-930	15		
419-5433-16	93	450-304	54				
419-5433-18	93	450-306	54	04-XXX-XXXXX			
419-5433-20	93	450-308	54	04-MST-00001	6		
419-5433-22	93	450-310	54	04-MST-00003	6		
419-5433-25	93	450-312	54	04-MST-00004	8		
		450-319	57	04-MST-00005	8		
430		450-320	57	04-MST-00006	8		
431-480-01	43	450-321	57	04-MST-00007	8		
431-481-01	43	450-322	57	04-MST-00008	8		
431-481-02	43	450-323	57	04-MST-00009	8		
431-481-03	43	450-324	57	04-MST-00010	8		
431-481-04	43	450-325	57	04-MST-00011	8		
431-482-01	43	450-326	57	04-MST-00013	6		
431-515	30	450-328	57	04-MST-00012	8		
431-517	30	450-330	57	04-MST-00014	8		
		450-332	57	04-MST-00015	8		
440		450-334	57	04-MST-00016	8		
440-500	54	450-335	57	04-MST-00017	8		
440-501	54	450-336	57	04-MST-00016	8		
440-504	54	450-337	57	04-MST-00017	8		
440-530	56	450-500	42	04-MST-00018	8		
		450-501	42	04-MST-00019	8		
				04-MST-00020	8		
				04-MST-00021	8		
				04-MST-00022	8		

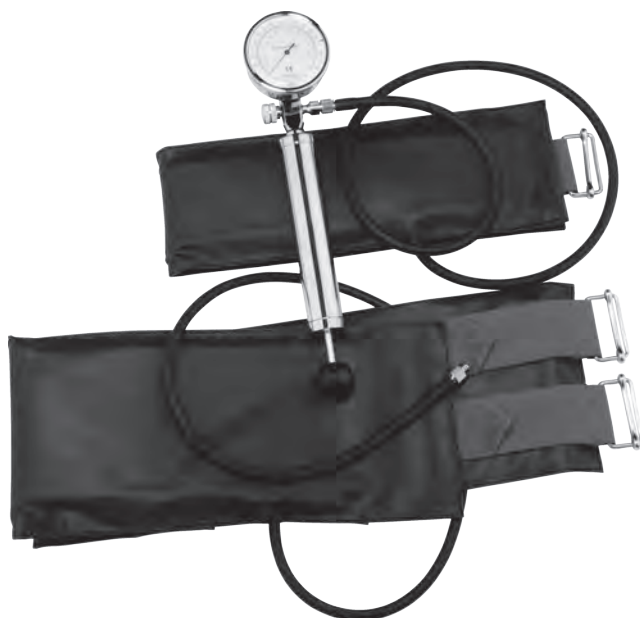

390-100

Komprimeter zur Erzeugung einer Bluteleere in den Extremitäten, Manometer mit Meßbereich bis 700mm Hg. Komplett bestehend aus:

- 390-102 1 Oberarm Manschette
- 390-103 1 Oberschenkel Manschette
- 390-101 1 Luftpumpe
- 390-104 1 Manometer

Comprimeter: Compression apparatus for producing exsanguination in the extremities. Manometer registers up to 700mm Hg. Complete consisting of:

- 390-102 1 Cuff for the arm
- 390-103 1 Cuff for the leg
- 390-101 1 Pump
- 390-104 1 Manometer

Torniquete para producir una isquemia local en las extremidades. Manómetro ajustado hasta 700mm Hg. Completo, compuesto de:

- 390-102 1 Brazaletes para el brazo
- 390-103 1 Brazaletes para el muslo
- 390-101 1 Bomba de aire
- 390-104 1 Manómetro

Appareil compresseur permettant de créer une ischémie dans les extrémités. Manomètre ajusté jusqu'à 700mm Hg. Complet, composé de:

- 390-102 1 Manchette pour les cuisse
- 390-103 1 Manchette pour la bras
- 390-101 1 Pompe à air
- 390-104 1 Manomètre

390-105

Kindermanschette
Cuff for children
Brazaletes para niños
Manchette pour les enfants



ESMARCH 390-122

Staubinde 5m lang und 100mm breit
Compression bandage 5m long and 100mm wide
Venda-compresión 5m largo y 100mm ancho
Bande compressive 5m long et 100mm large



**PERCY
390-300**

Griff abnehmbar
Removable handles
Mangos desmontables
Manches démontables

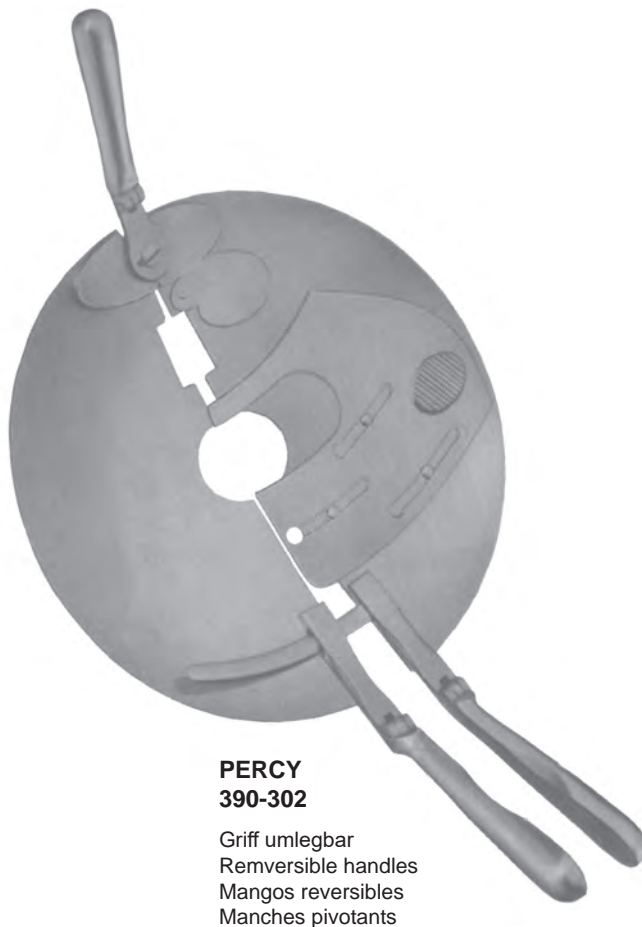

**PERCY
390-302**

Griff umlegbar
Remversible handles
Mangos reversibles
Manches pivotants



390-441 4mm
390-442 6mm
390-443 8mm

Ersatzsägeblatt (kein Medizinprodukt)
spare saw blade (no medical device)
hoja de repuesto (no es un producto sanitario)
lame de rechange (pas de produit médical)

**BIER
390-440**
390mm, 15 3/8"

komplett mit je 1 Sägeblatt 4mm, 6mm, 8mm
complete with 1 each saw blade 4mm, 6mm, 8mm
completo con 1 hoja de 4mm, 6mm, 8mm
complet avec 1 lame de 4mm, 6mm, 8mm



LANGENBECK
390-400 235mm, 9 1/2"



CHARRIERE
390-410 270mm, 10 3/4"

390-400

Ersatzsägeblatt (kein Medizinprodukt)
spare saw blade (no medical device)
hoja de repuesto (no es un producto sanitario)
lame de rechange (pas de produit médical)



SATTERLEE
390-420 300mm, 12"

390-421

Ersatzsägeblatt (kein Medizinprodukt)
spare saw blade (no medical device)
hoja de repuesto (no es un producto sanitario)
lame de rechange (pas de produit médical)



CHARRIERE
390-430 350mm, 13 3/4"

komplett mit je 1 Sägeblatt 12mm, 18mm
complete with 1 each saw blade 12mm, 18mm
completo con 1 hoja de 12mm, 18mm
complet avec 1 lame de 12mm, 18mm

390-431 12mm
390-432 18mm

Ersatzsägeblatt (kein Medizinprodukt)
spare saw blade (no medical device)
hoja de repuesto (no es un producto sanitario)
lame de rechange (pas de produit médical)



BAILEY-DEMARTEL
340-835
330mm, 13"



GIGLI
390-500

Paar
pair
paire
par



GIGLI
390-501

Paar
pair
paire
par

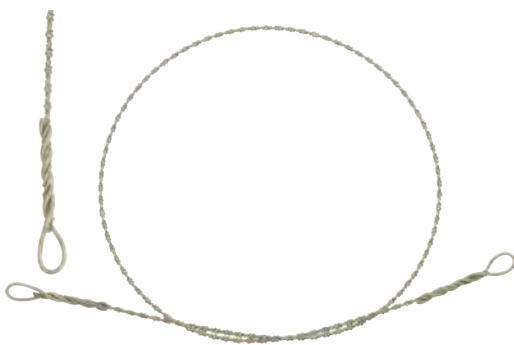

GIGLI OLIVECRONA

	Länge length longueur longitud	Durchmesser diameter diametre diametro
390-512-30	300mm	1,2mm
390-512-40	400mm	1,2mm
390-512-50	500mm	1,2mm
390-512-60	600mm	1,2mm
390-512-70	700mm	1,2mm

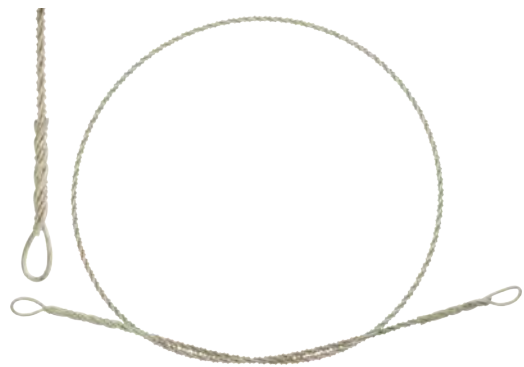

GIGLI OLIVECRONA

	Länge length longueur longitud	Durchmesser diameter diametre diametro
390-514-30	300mm	1,4mm
390-514-40	400mm	1,4mm
390-514-50	500mm	1,4mm
390-514-60	600mm	1,4mm
390-514-70	700mm	1,4mm



MARTIN
400-331 210mm, 8 1/4"



ENGEL
400-410 150mm, 6"



HOPKINS
400-300 200mm, 8"



ESMARCH
400-310 180mm, 7"

04-MST-00001 Plaster Saw, 230 V / 50-60 Hz

04-MST-00003 Plaster Saw, 110 V / 50-60 Hz

complete with:

- 1 x sawblade Ø 50mm for standard plaster (**04-MST-00004**)
- 1 x sawblade Ø 65mm (**04-MST-00007**)
- 1 x pair of wrenches
- 1 x instruction manual

TECHNICAL DATA

- 500 Watt power
- 3500 bis 24000 oscillations, infinitely variable
- Fully automatic power-compensation
- Slim motor design with silent motor 52 – 77 dB(A)
- Soft Start at switch-on to minimize accident risk and to save all mechanical and electrical components
- Safety ON / OFF switch
- Weight only 1,25 kg without cable
- Vibration- and maintenance-free
- 5 meter cable with EU-connection, 230 Volt
3 meter cable with US-connection, 110 Volt
- Double protection isolation according to class II, medical use of type BF
- Radio and TV suppressed
- CE conformity
- EN 60601-1, EN 60601-1-2, IEC 60601-1,
- 2 years warranty / 1 year guarantee on engine and transmission part (in case of proper use)



04-MST-00013 Transport case, plastic

04-MST-00001 Sierra de yeso electrica, 230 V / 50-60 Hz

04-MST-00003 Sierra de yeso electrica, 110 V / 50-60 Hz

Completo con:

- 1 x hoja Ø 50mm para yeso normal (**04-MST-00004**)
- 1 x hoja Ø 65mm para yeso normal (**04-MST-00004**)
- 1 x Juego de llaves 11mm / 1 x manual de instrucciones

DATOS TECNICOS

- 500 vatios potencia
- 3500 hasta 24000 oscilaciones, infinitamente regulable
- Compensación de alimentación automática
- Delgado diseño del motor con motor silencioso 52-77 dB(A)
- Nuevo sistema electronica con varias funciones de protección y seguridad
- Conector de seguridad ON / OFF
- Peso solamente 1,25 kg sin cable
- Sin vibraciones y mantenimiento
- 5 metros de cable con conexión EU, 230 voltios
3 metros de cable con conexión US, 110 voltios
- Isolación doble protección según clase II, uso medical del tipo BF
- TV y radio suprimido / Conformidad de CE
- Testado según EN 60601-1, EN 60601-1-2, IEC 60601-1,
- 2 años de garantía / 1 año de garantía al motor & parte de transmisión (en caso de uso adecuado)

04-MST-00013 Maleta de transporte, plástica

04-MST-00001 Scie à plâtre, 230 V / 50-60 Hz

04-MST-00003 Scie à plâtre, 110 V / 50-60 Hz

complète avec :

- 1 x lame de scie Ø 50mm (**04-MST-00004**)
- 1 x lame de scie Ø 65mm (**04-MST-00004**)
- 1 x paire de clés 11mm / 1 x mode d'emploi

DATES TECHNIQUES

- puissance 500 watt
- 3500 à 24000 oscillations, réglable en continu
- compensation autom. de puissance
- design mince du moteur avc. moteur silencieux 52-77dB(A)
- démarrage doux pour réduire risque d'accident et pour protéger les éléments mécaniques et électroniques
- commutateur de sécurité ON / OFF
- poids seulement 1,25 kg, sans câble
- exempt de vibrations et entretien pas nécessaire
- câble de 5 m avec connexion CE, 230 volt
câble de 3 m avec connexion USA, 110 volt
- protection double d'isolation conformément à classe II, utilisation médicale type BF
- ondes radio et TV supprimées / conformité CE
- conformité EN 60601-1, EN 60601-1-2, IEC 60601-1,
- 2 ans de garantie / 1 an pour moteur et élément de transmission (lors d'utilisation conforme)

04-MST-0013 Mallette en plastique, pour transport



04-MST-00023 Plaster Saw (400-450) with dust collector, 230 V / 50-60 Hz
04-MST-00025 Plaster Saw (400-452) with dust collector, 110 V / 50-60 Hz

complete with:

- 1 x sawblade Ø 50mm for standard plaster (**04-MST-00004**)
- 1 x sawblade Ø 65mm (**04-MST-00004**)
- 1 x pair of wrenches / 1 x HEPA Filter

TECHNICAL DATA - dust collector

- 400 - 750 Watt power, vacuum motor
- Continuous Power Output max. 1200 Watt,
- Max. Power Output 1450 Watt PT,
- HEPA-Filter 99,97% of all particles which are >= 0,3 micron are filtered
- Automatic turn on/off of the cleaner with the turn on/off of the plaster saw
- When plaster saw is turned off, the cleaner will go off 6-10 sec. later to clean the whole system
- Max. vacuum 2100mm/H₂O, vacuum motor
- Max. vacuum 1900mm/H₂O, vacuum machine
- Air flow motor 62 lt./sec. in the machine, due to all the filters the air flow goes down to 40 lt./sec.
- Electronic power control 500 W – 1200 W
- Max. total power (system) 1600 Watt, controlled
- Noise level vacuum only, 63 – 69 dB(A)
- Antistatic cleaner tube
- Control lamp for full dust bag
- Cleaner tube is in the pipe and not on the floor

04-MST-00027 HEPA Filter

04-MST-00028 Dust Bag

04-MST-00029 Perfume Stick

04-MST-00030 Motor Filter

04-MST-00023 Sierra de yeso electrica (400-450) con aspirador, 230 V

04-MST-00025 Sierra de yeso electrica (400-450) con aspirador, 110 V

Completo con:

- 1 x hoja Ø 50mm para yeso normal (**04-MST-00004**)
- 1 x hoja Ø 65mm para yeso normal (**04-MST-00004**)
- 1 x Juego de llaves 11mm / 1 x manual de instrucciones

DATOS TECNICOS - con aspirador

- 400 - 750 vatios potencia, motor vacío
- Potencia continua de salida max. 1200 vatios
- Max. potencia de salida 1450 vatios PT
- Filtro HEPA 99,97% de todas las partículas cuales son >= 0,3 micron son filtradas
- Encendido / Apagado automático de la aspiradora junto con encendido / apagado de la sierra de yeso
- Cuando la sierra de yeso esta apagada la aspiradora se apagará 6-10 sec. después para limpiar todo el sistema
- Max. vacío 2100mm/H₂O, motor vacío
- Max. vacío 1900mm/H₂O, maquina vacío
- Flujo del aire del motor 62 lt./sec. en la maquina debido a los filtros el flujo del aire se baja a 40 litros./sec.
- Control electronico de potencia 500 vatios – 1200 vatios
- Max. potencia total (sistema) 1600 vatios, controlado
- Nivel de ruido solo del vacío 63 – 69 dB(A)
- Tubo del aspirador antiestático
- Lampara de control para bolsa de polvo
- Manguera del aspirador es dentro del tubo y no al suelo

04-MST-00027 Filtro HEPA

04-MST-00028 Bolsa de polvo

04-MST-00029 Palo de perfume

04-MST-00030 Filtro para el motor

04-MST-00023 Scie à plâtre (400-450) avec aspirateur, 230 V / 50-60 Hz

04-MST-00025 Scie à plâtre (400-450) avec aspirateur, 110 V / 50-60 Hz

complète avec :

- 1 x lame de scie Ø 50mm (**04-MST-00004**)
- 1 x lame de scie Ø 65mm (**04-MST-00004**)
- 1 x paire de clés 11mm / 1 x mode d'emploi

DATES TECHNIQUES - aspirateur

- puissance 400 - 750 watt, moteur vacuum
- sortie puissance continue max. 1200 watt
- sortie puissance max. 1450 Watt PT
- filtre HEPA - filtration de 99,97% de tous particules >= 0,3 micron
- démarrage / arrêt automatique de l'aspirateur dépendant du démarrage / de l'arrêt de la scie
- pour nettoyage du système entier, l'aspirateur s'arrête avec une temporisation de 6-10 sec. après arrêt de la scie à plâtre
- construction robuste pour charge élevée
- vacuum max. 2100mm/H₂O, moteur vacuum
- vacuum max. 1900mm/H₂O, machine vacuum
- débit air moteur 62 lt./sec. dans la machine ; les filtres contenus réduisent ce débit à 40 lt./sec.
- commande puissance électronique 500 W – 1200 W
- puissance max. totale (système) 1600 Watt, contrôlé
- niveau du bruit - seulement vacuum 63 – 69 dB(A)
- lampe de contrôle pour sac collecteur poussière plein

04-MST-00027 Filtre HEPA

04-MST-00028 Sac collecteur poussière

04-MST-00029 Stick perfume

04-MST-00030 Filtre moteur



Sägeblätter, für standardgips
Saw Blades, for standard plaster
Hojas para yeso normal
Lames de scie, pour plâtre standard

04-MST-00010 Ø 45mm
04-MST-00004 Ø 50mm
04-MST-00007 Ø 65mm



Sägeblätter, für standardgips
Saw Blades, for standard plaster
Hojas para yeso normal
Lames de scie, pour plâtre standard

04-MST-00014 Ø 65mm



Sägeblätter, für standardgips
Saw Blades, for standard plaster
Hojas para yeso normal
Lames de scie, pour plâtre standard

04-MST-00016 Ø 65mm

Sägeblätter, für synthetischengips
Saw Blades, for synthetic casts
HOJAS, para vendajes sintéticos
Lames de scie, pour bandage synthétique

04-MST-00011 Ø 45mm
04-MST-00005 Ø 50mm
04-MST-00008 Ø 65mm

Sägeblätter, für synthetischengips
Saw Blades, for synthetic casts
HOJAS, para vendajes sintéticos
Lames de scie, pour bandage synthétique

04-MST-00015 Ø 65mm

Sägeblätter, für synthetischengips
Saw Blades, for synthetic casts
HOJAS, para vendajes sintéticos
Lames de scie, pour bandage synthétique

04-MST-00017 Ø 65mm

Sägeblätter, PTFE antihaft beschichtet
Saw Blades, PTFE non-stick coating
HOJAS, antiadherente PTFE
Lames de scie, PTFE, avec revêtement anti-adhérent

04-MST-00006 Ø 50mm
04-MST-00009 Ø 65mm



Excentrische Scheibe,
zur Schnitttiefenregulierung
Eccentric disc,
to limit cutting depth
Disco de Excéntrico
para limitar la profundidad del corte
Disque excentrique, pour
limitation de profondeur de coupe

04-MST-00022

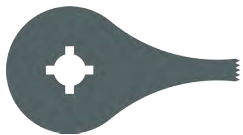

Sägeblätter, für standardgips
Saw Blades, for standard plaster
Hojas para yeso normal
Lames de scie, pour plâtre standard

04-MST-00018 8mm

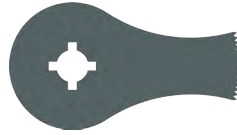

Sägeblätter, für standardgips
Saw Blades, for standard plaster
Hojas para yeso normal
Lames de scie, pour plâtre standard

04-MST-00020 20mm

Sägeblätter, für synthetischengips
Saw Blades, for synthetic casts
HOJAS, para vendajes sintéticos
Lames de scie, pour bandage synthétique

04-MST-00019 8mm

Sägeblätter, für synthetischengips
Saw Blades, for synthetic casts
HOJAS, para vendajes sintéticos
Lames de scie, pour bandage synthétique

04-MST-00021 20mm

Spannschlüssel 11mm
Wrench, pair 11mm
Juego de llaves 11mm
Clés, paire, 11mm



04-MST-00012



ein Blatt gezahnt
one serrated blade
una hoja dentada
une lame dentelée

LISTER EXCENTRIC
124-261
160mm, 6 1/4"



124-251 180mm, 7"
124-253 140mm, 5 1/2"



BERGMANN
124-227
230mm, 9"



ESMARCH
124-321 200mm, 8"
124-323 220mm, 8 3/4"

ELCON 410

VERBANDSCHEREN, GIPSSCHEREN
BANDAGE SCISSORS, PLASTER SHEARS
TIJERAS PARA VENDAJES, TIJERAS PARA YESO
CISEAUX POUR PANSEMENTS, CISEAUX POUR PLÂTRE



LORENZ
124-225
240mm, 9 1/2"



SEUTIN
124-305
230mm, 9"



BRUNS
124-331
240mm, 9 1/2"



BRUNS
124-333
240mm, 9 1/2"



gezahnt
serrated
dentada
dentelée

Scheren mit Hartmetallschneiden, Scissors with tungsten carbide edges
Tijeras con filos de carburo tungsteno, Ciseaux avec des lames en tungstène

TUNGSTENCUT

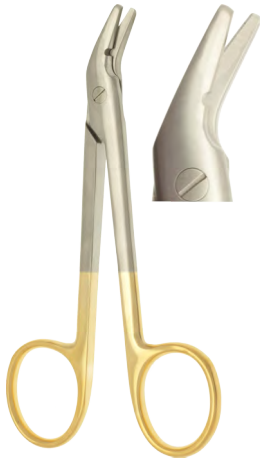

gezahnt
serrated edge
estriada
dentelés

UNIVERSAL
121-099
120mm, 4 3/4"



LISTER
121-905
180mm, 7"



BRUNS
121-917
240mm, 9 1/2"



400-500



400-502

WOLF-BÖHLER

400-500 180mm, 7"

400-502 240mm, 9 1/2"



STILLE

400-201 230mm, 9"

400-203 260mm, 10 1/4"

400-211 380mm, 15 1/8"



HENNING
400-520 270mm, 10 3/4"



400-520
400-530



BEESON
400-530 300mm, 12"

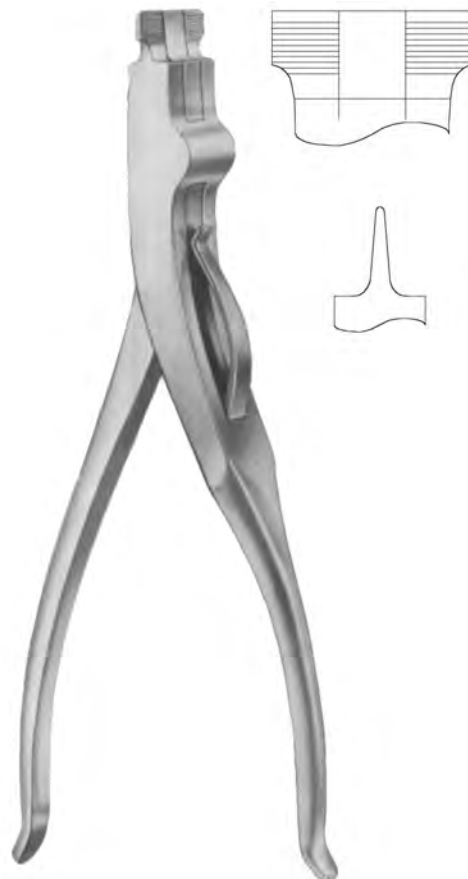

USA
400-515 230mm, 9"



410-090
170mm, 6 3/4"



410-092
160mm, 6 1/4"

5,5mm



**WILLIGER
410-112**
160mm, 6 1/4"

7mm



**WILLIGER
410-114**
160mm, 6 1/4"

5,5mm



410-119
160mm, 6 1/4"

4,5mm



**KOENIG
410-116**
150mm, 6"

4,5mm



**KOENIG
410-117**
150mm, 6"

5mm



**SEBILEAU
410-120**
170mm, 6 3/4"



Mc DONALD
410-160
 190mm, 7 1/2"



9,5mm

10,5mm

WATSON-CHEYNE
410-165
 175mm, 6 7/8"



6mm

8mm

ALDERDYCE
470-930
 210mm, 8 1/4"



9mm

CAIRNS
410-121
 175mm, 6 3/4"

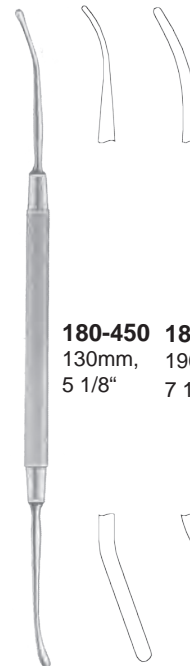

2mm

2mm

180-450 180-451
 130mm, 190mm,
 5 1/8" 7 1/2"

2,5mm

2,7mm

WATSON-CHEYNE
180-450 - 180-451

ELCON 410

ELEVATORIEN
ELEVATORS
ELEVADORES
ELÉVATEURS

6mm



Hohlheft
Hollow Handle
Mango Hueco
Manche Creux

**QUERVAIN
410-130**
200mm, 8"

8mm



Hohlheft
Hollow Handle
Mango Hueco
Manche Creux

**LANGENBECK
410-132**
200mm, 8"

10mm



Hohlheft
Hollow Handle
Mango Hueco
Manche Creux

**LANGENBECK
410-134**
200mm, 8"

11mm



**LANGENBECK
410-128**
230mm, 9"

6mm



Vollergriff
Solid Handle
Mango Pleno
Manche Massive

**QUERVAIN
410-126**
200mm, 8"

8mm



410-122
200mm, 8"
Vollergriff
Solid Handle
Mango Pleno
Manche Massive

**LANGENBECK
410-122 - 410-124**

10mm



410-124
200mm, 8"

5mm

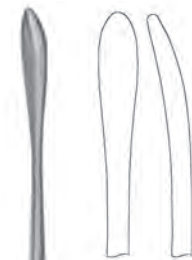

410-1291
170mm, 6 3/4"

8mm



410-1293
170mm, 6 3/4"

7mm

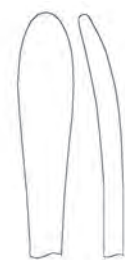

410-1292
170mm, 6 3/4"

10mm



410-1294
170mm, 6 3/4"

**MINI-LANGENBECK
410-1291 - 410-1294**

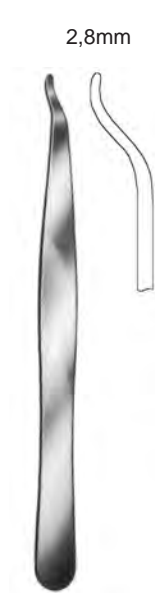

410-100
 140mm, 5 1/2"



410-102
 150mm, 6"

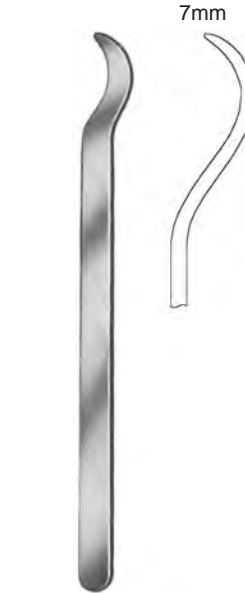

410-104
 150mm, 6"

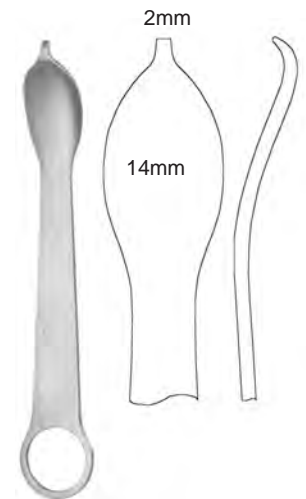

410-109
 120mm, 5"

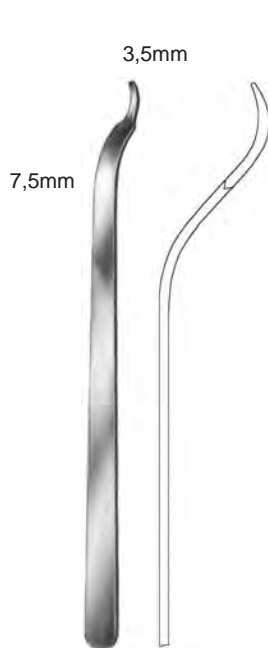

BUCK-GRAMCKO
410-107
 150mm, 6"

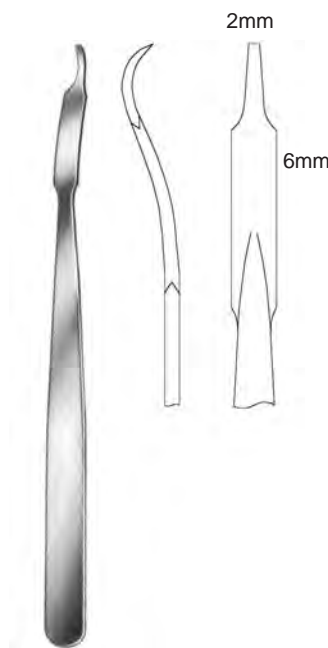

HOHMANN
410-105
 160mm, 6 1/4"

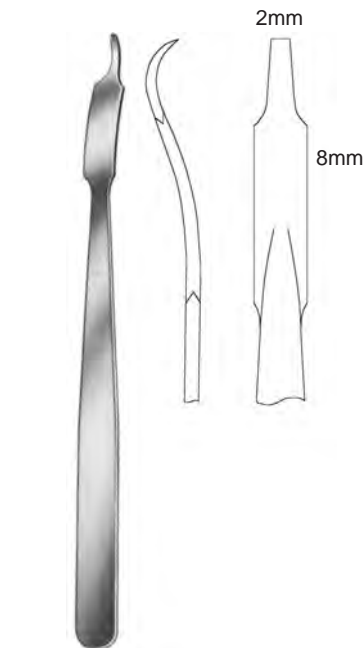

HOHMANN
410-106
 160mm, 6 1/4"



410-108
 160mm, 6 1/4"

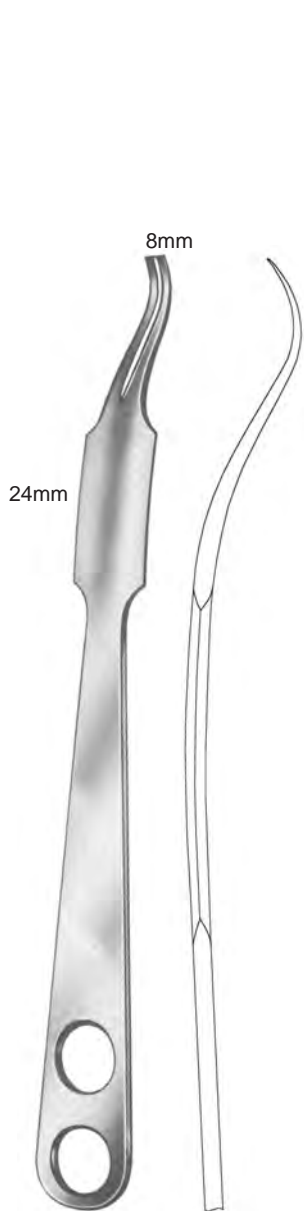

LANGE-HOHMANN
410-200
250mm, 10"

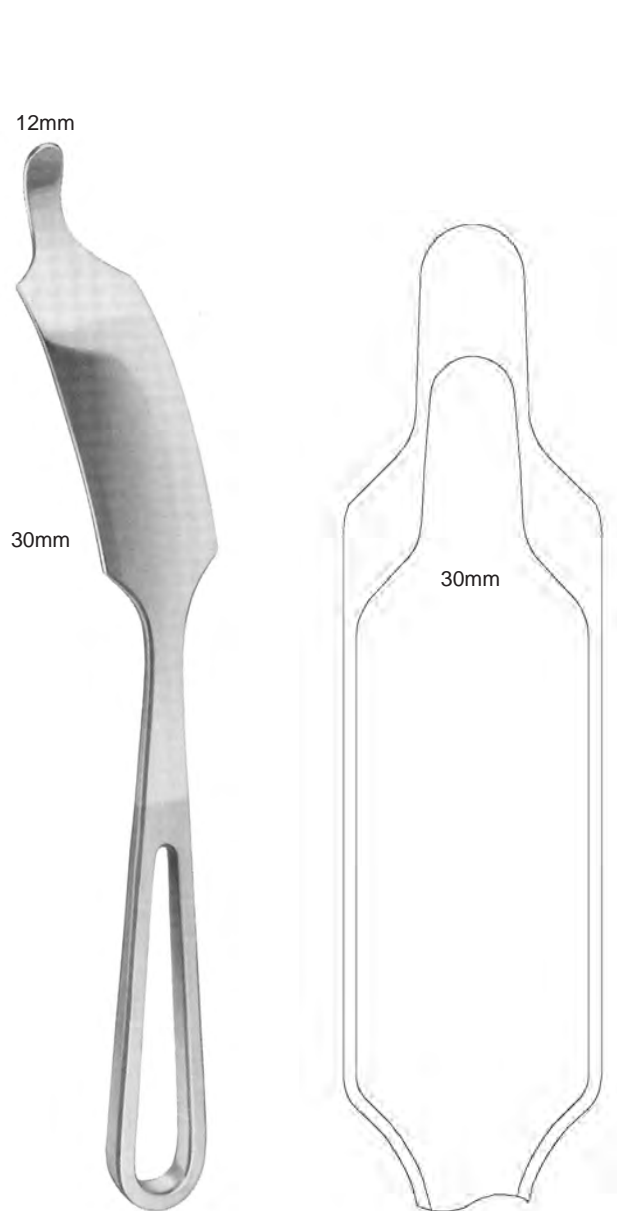

LANGE-HOHMANN
410-202
265mm, 10 1/2"



LANGE-HOHMANN
410-204
290mm, 11 1/2"

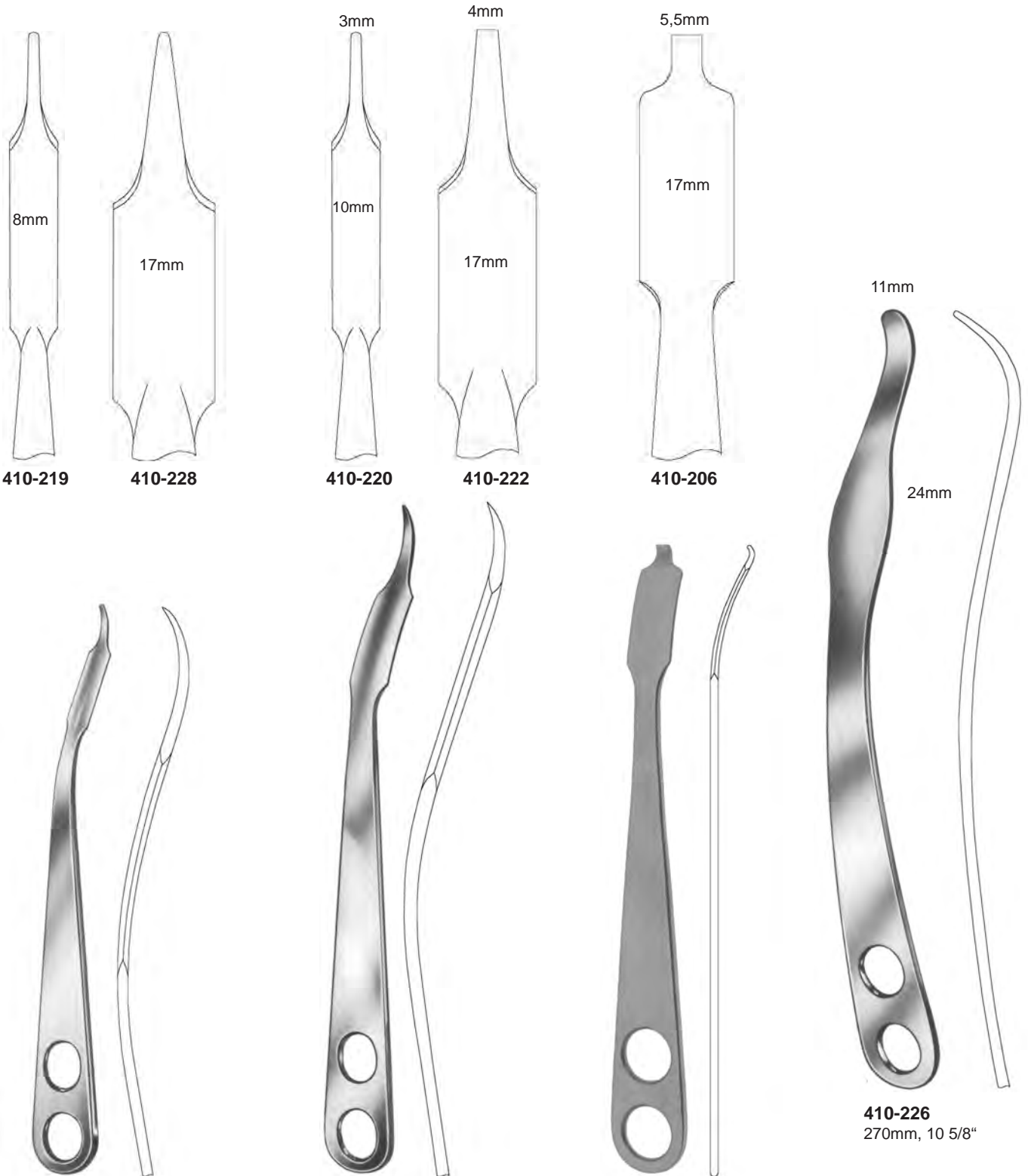

410-219

410-228

410-220

410-222

410-206

410-226
 270mm, 10 5/8"

HOHMANN

410-219 220mm, 8 3/4"

410-228 240mm, 9 1/2"

HOHMANN

410-220 220mm, 8 3/4"

410-222 240mm, 9 1/2"

WAGNER

410-206
 220mm, 8 3/4"

ELCON

410

KNOCHENHEBEL
BONE LEVERS
ELEVADORES PARA HUESO
LEVERS À OS

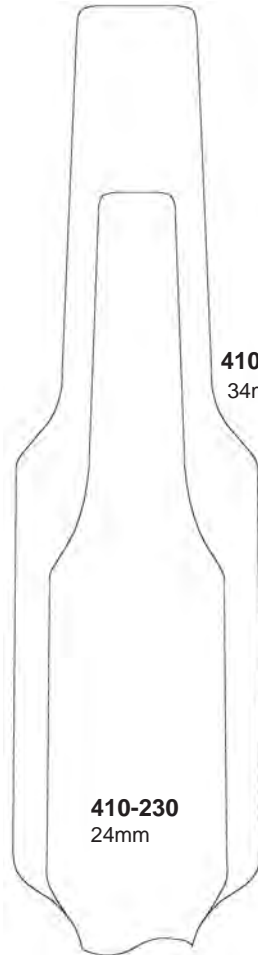
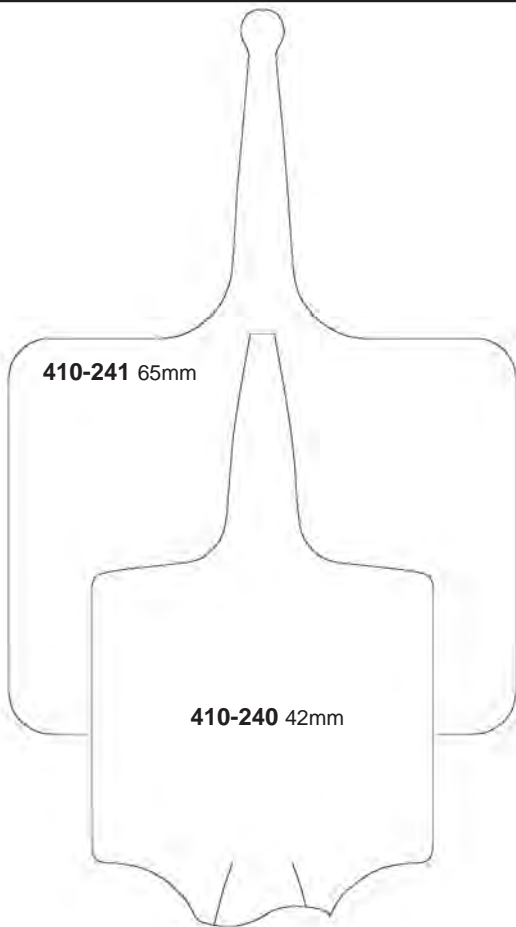

410-240 410-241

HOHMANN

410-230 260mm, 10 1/4"

410-231 290mm, 11 1/2"

VERBRUGGE
410-240 240mm, 9 1/2"
410-241 255mm, 10"

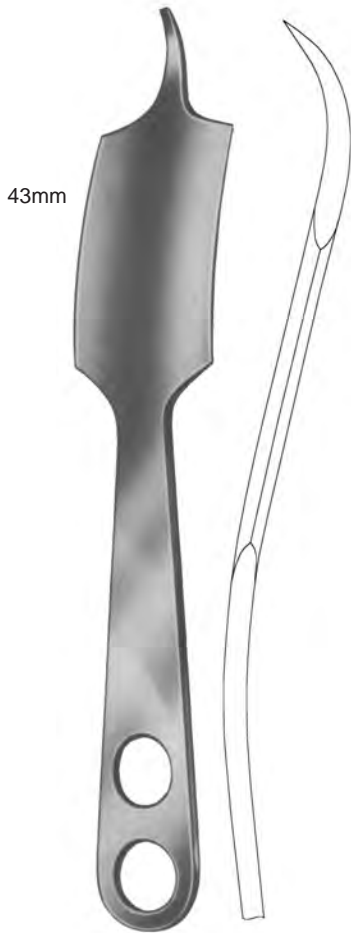

HOHMANN
410-244
245mm, 9 3/4"

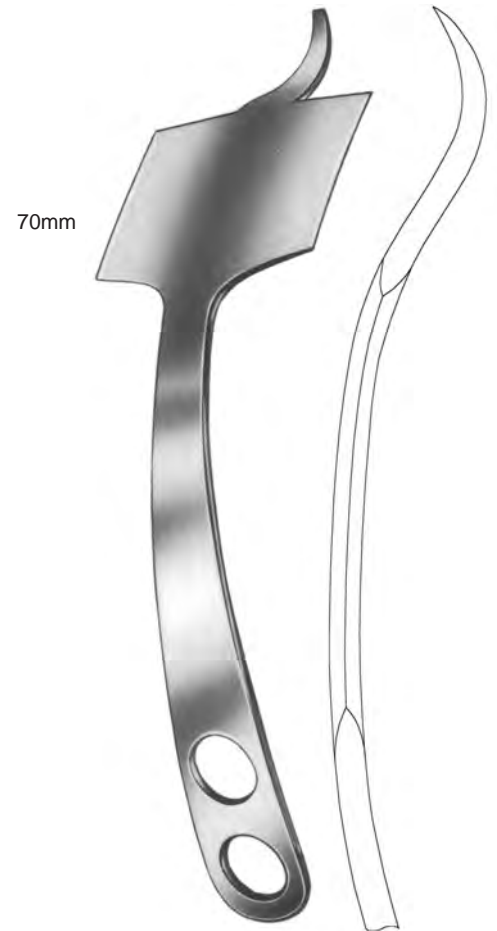

HOHMANN
410-246
250mm, 10"

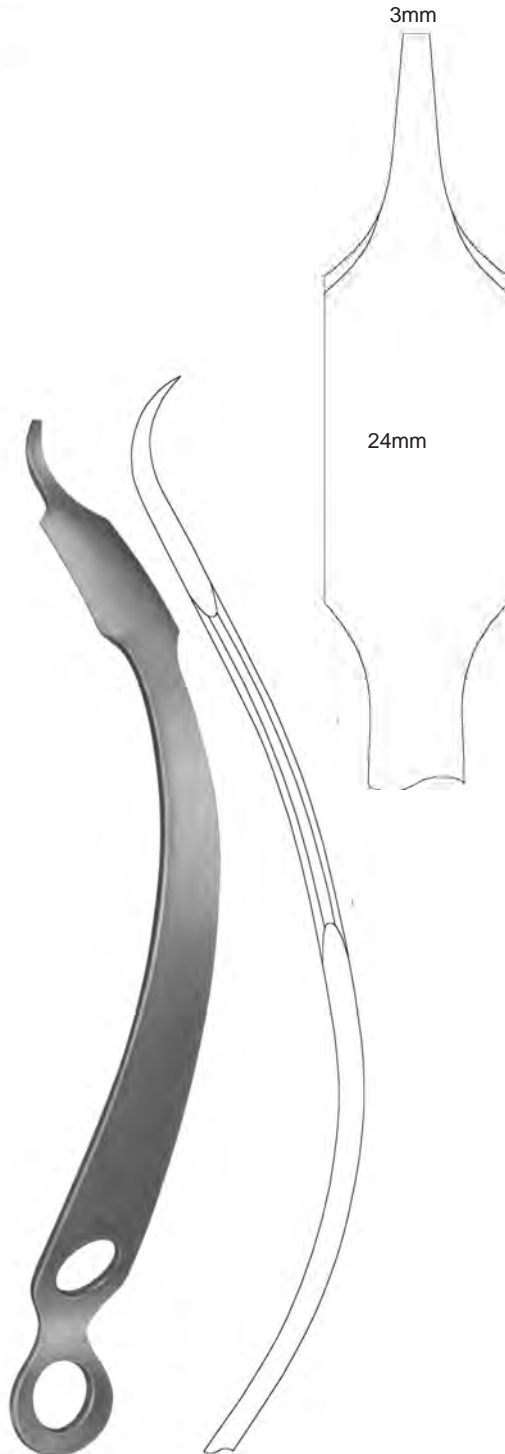

HOHMANN
410-210
270mm, 10 3/4"



**LANE-
THRETHOWAN**
410-256
215mm, 8 1/2"

WATSON-JONES
410-251
280mm, 11"

LANE
410-253
265mm, 10 1/2"

LANE
410-254
255mm, 10"

BRISTOW
410-359 180mm, 7"
410-360 230mm, 9"

BLOUNT
410-262
265mm, 10 1/2"

410-285

glatt, smooth, lisa, lisse
spitz, pointed, agudo, pointu

410-286

gerieft, serrated, estriada, strié
stumpf, blunt, romo, mousse

410-287

glatt, smooth, lisa, lisse
stumpf, blunt, romo, mousse

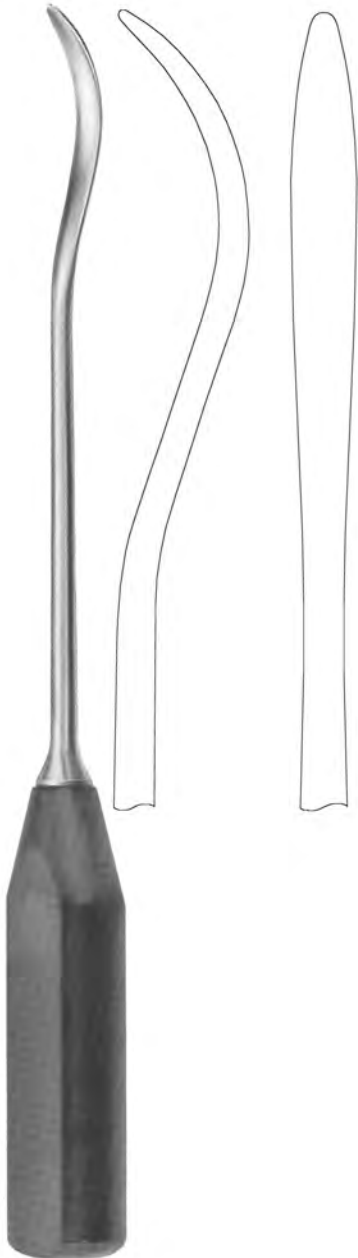

WAGNER
410-265
330mm, 13"



BENNET
410-270 44mm
410-271 64mm
255mm



AUFRANC-COBRA
410-285 - 410-287
280mm, 11"

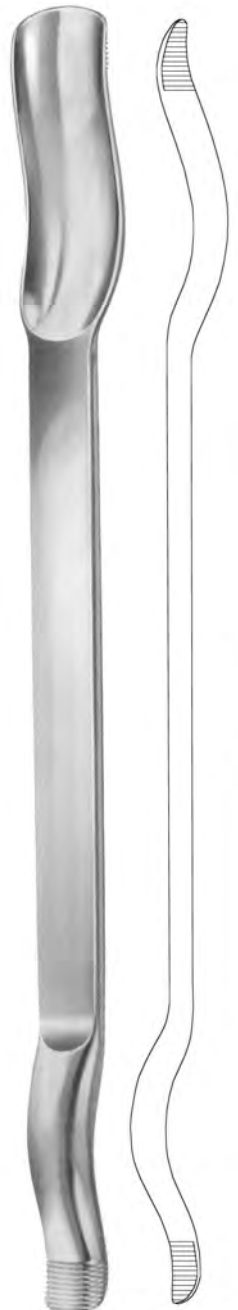

MURPHY-LANE
410-196 30/19mm
310mm, 12 1/4"



WILLIGER
410-300
130mm, 5"



WILLIGER
410-302
160mm, 6 1/4"

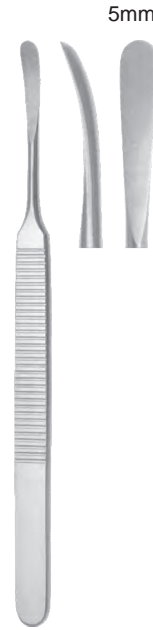

KÖNIG
410-306
155mm, 6"

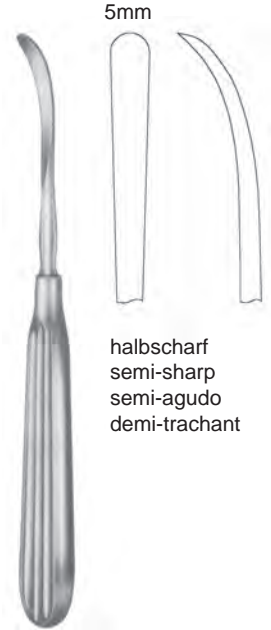

LOVE-ADSON
340-966
170mm, 6 3/4"

halbscharf
semi-sharp
semi-agudo
demi-trachant



ADSON
340-954
165mm, 6 1/2"



CUSHING
340-912 - 340-915

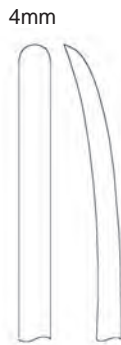

340-912
175mm, 7"

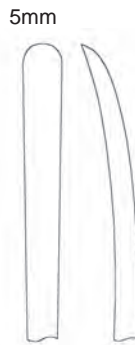

340-913
175mm, 7"



340-914
195mm, 7 3/4"



340-915
195mm, 7 3/4"

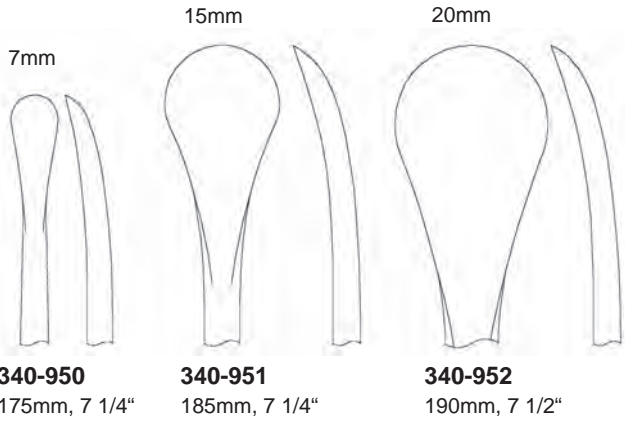

340-950

175mm, 7 1/4"

340-951

185mm, 7 1/4"

340-952

190mm, 7 1/2"

voller Griff
 solid handle
 mango pleno
 manche massive

HOEN
340-950 - 340-952

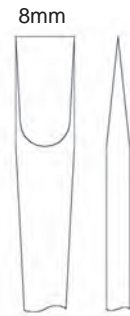

voller Griff
 solid handle
 mango pleno
 manche massive

CUSHING

340-929

170mm, 6 3/4"



6mm

CUSHING
340-910
 150mm, 6"
 (Little Joker)



6mm

PENNYBAKER
340-935
 165mm, 6 1/2"

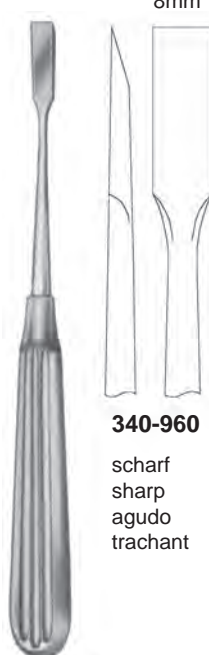

8mm

ADSON
340-960 - 340-963
 170mm, 6 3/4"

340-960

scharf
 sharp
 agudo
 trachant



340-961

stumpf
 blunt
 romo
 mousse



340-962

halbscharf
 semi-sharp
 semi-agudo
 demi trachant

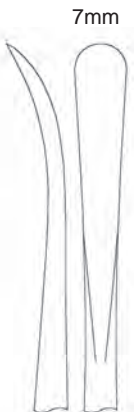

340-963

halbscharf
 semi-sharp
 semi-agudo
 demi tachant

4mm

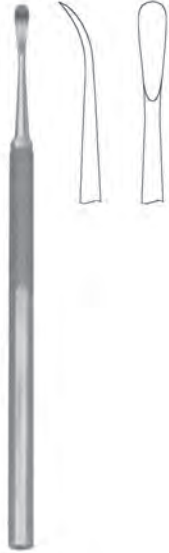

PARTSCH
410-315
145mm, 5 3/4"

5,5mm



WARD
440-614
170mm, 6 3/4"

4mm



450-741

4mm



450-740



ROSE
450-740 - 450-741
140mm, 5 1/2"

6mm

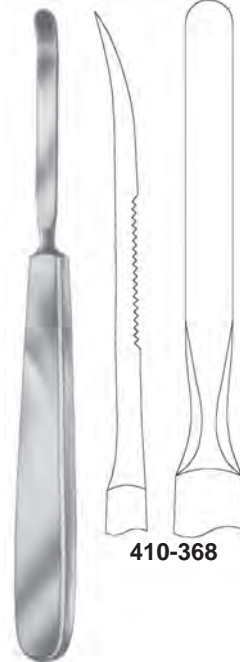

410-368

8mm

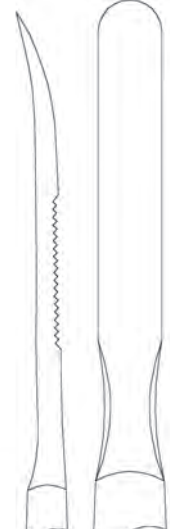

410-369

PLESTER
410-368 - 410-369
170mm, 6 3/4"



HALLE
440-611 160mm, 6 1/4"
440-612 180mm, 7"



ST CLAIR THOMPSON
440-636 160mm, 6 1/4" scharf sharp agudo trachant
440-637 stumpf blunt roma mousse



SEWALL
440-618 200mm, 8"



LEMPERT

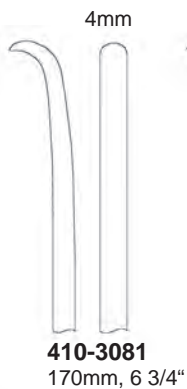

410-3081
 170mm, 6 3/4"

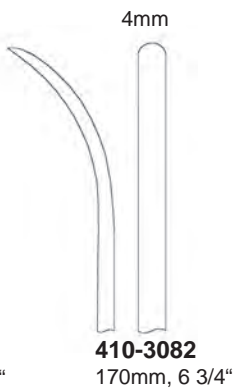

410-3082
 170mm, 6 3/4"

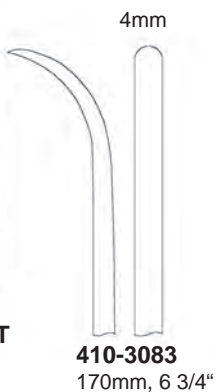

410-3083
 170mm, 6 3/4"

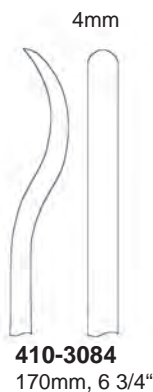

410-3084
 170mm, 6 3/4"



410-393-01

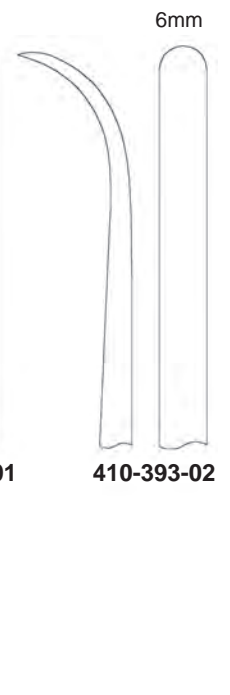

410-393-02

410-393-01 - 410-393-02
 170mm, 6 3/4"

ELCON 410

ELEVATORIEN, RASPATORIEN
ELEVATORS, PERIOSTEAL ELEVATORS
ELEVADORES, PERIOSTOMOS
ELEVATEURS, RUGINE-RASPATOIRES

4,5mm



FREER

440-615

440-616

190mm, 7 1/2"

scharf
sharp
agudo
aigu

stumpf
blunt
romo
mousse

4,5mm

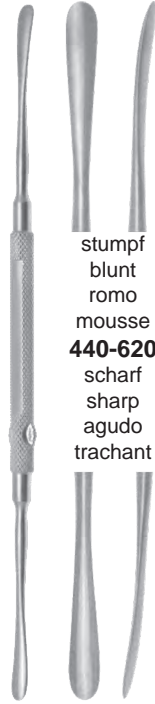

FREER

440-620

185mm, 7 1/4"

440-621

200mm, 8"

stumpf
blunt
romo
mousse
440-620
scharf
sharp
agudo
trachant

6,5mm

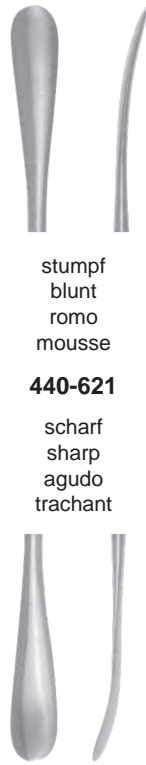

stumpf
blunt
romo
mousse

440-621

scharf
sharp
agudo
trachant



stumpf
blunt
romo
mousse
452-270
stumpf
blunt
romo
mousse

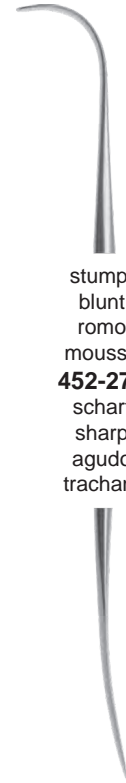

stumpf
blunt
romo
mousse
452-271
scharf
sharp
agudo
trachant

OBWEGGESER-FREER

452-270 210mm, 8 1/4"

452-271 205mm, 8"

4mm

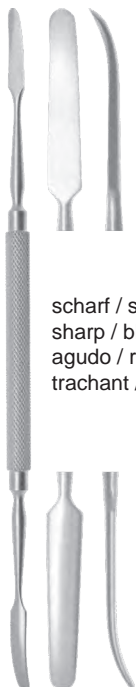

KILLIAN

440-603

180mm, 7"

scharf / stumpf
sharp / blunt
agudo / romo
trachant / mousse

4,5mm

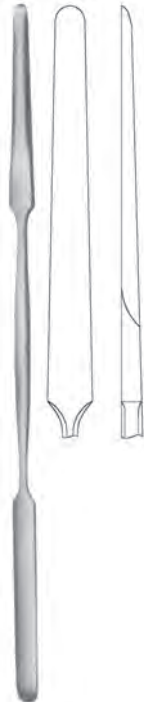

KILLIAN

440-602

185mm, 7 1/4"

scharf / stumpf
sharp / blunt
agudo / romo
trachant / mousse

5,5mm

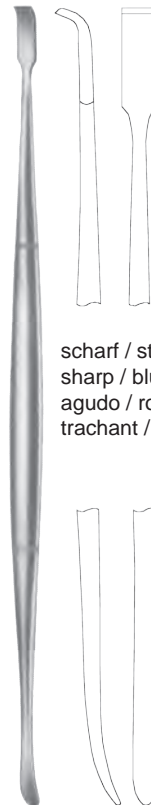

scharf / stumpf
sharp / blunt
agudo / romo
trachant / mousse

HOWARTH

440-626

215mm, 8 1/2"

4,5mm

3mm

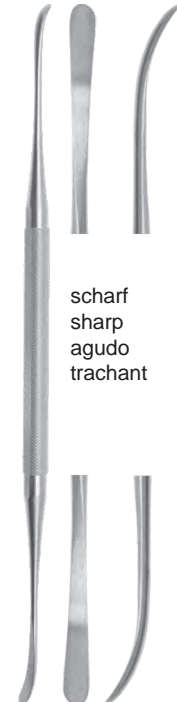

scharf
sharp
agudo
trachant

FREER-YASARGIL

440-627

185mm, 7 1/4"

4,5mm

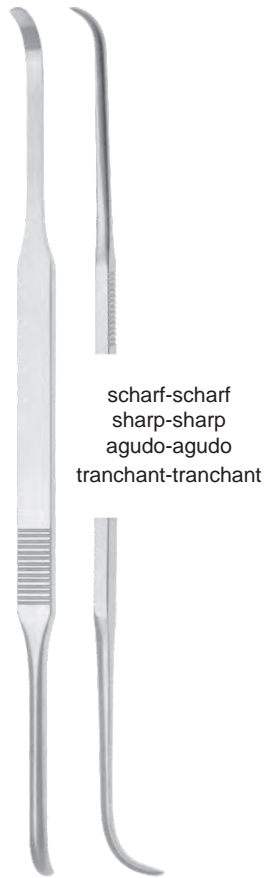

scharf-scharf
 sharp-sharp
 agudo-agudo
 tranchant-tranchant

COTTLE
450-733 230mm, 9"

4mm



COTTLE-McKENTY
450-732 220mm

4mm



stumpf
 blunt
 romo
 mousse

scharf
 sharp
 agudo
 tranchant

5mm

HILL
440-660
 220mm, 8 3/4"

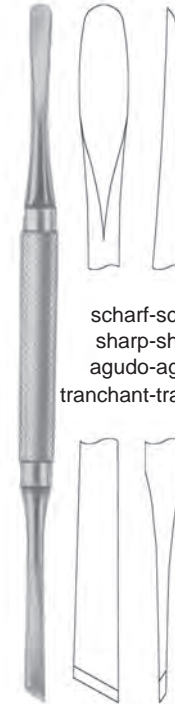

scharf-scharf
 sharp-sharp
 agudo-agudo
 tranchant-tranchant

MEAD
440-666
 165mm, 6 1/4"



scharf-scharf
 sharp-sharp
 agudo-agudo
 tranchant-tranchant

MOLT
440-665
 180mm, 7"

8mm



scharf
 sharp
 agudo
 trachant

COTTLE
450-708
 195mm, 7 3/4"

4,7mm



LANDOLT
410-313
 175mm, 7"

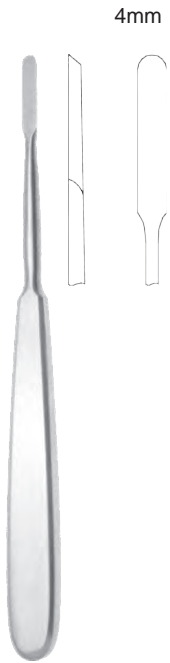

JOSEPH
450-698
160mm, 6 1/4"



JOSEPH
450-706
160mm, 6 1/4"

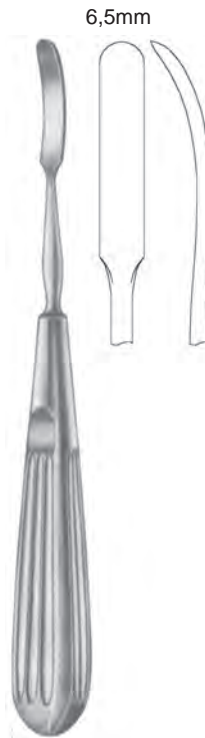

JOSEPH
450-707
180mm, 7"



LEMPERT
431-517
180mm, 7"



LEMPERT
431-515
205mm, 8"



LEMPERT
450-700 - 450-703
170mm, 6 3/4"



450-701

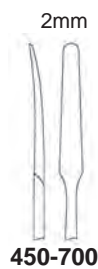

450-700

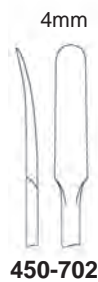

450-702



450-703

15mm

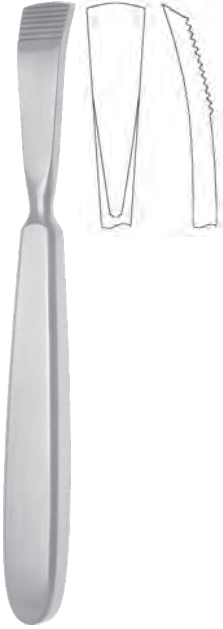

JANSEN
410-324
 165mm, 6 1/2"

13mm

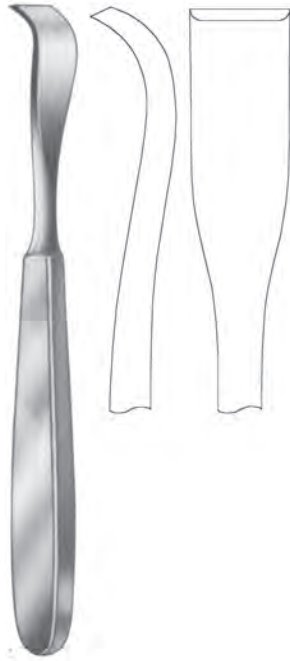

SCHNEIDER
410-325
 175mm, 7"

13mm

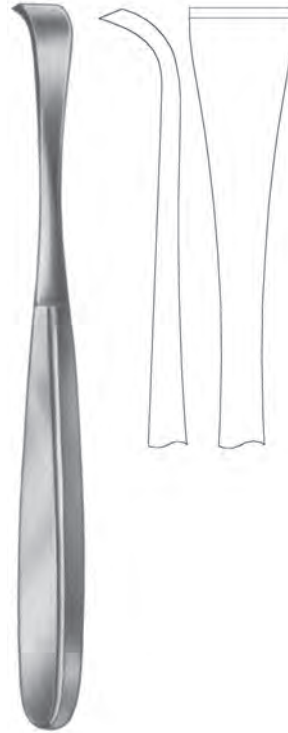

SCHNEIDER-SAUERBRUCH
410-327
 190mm, 7 1/2"

18mm



SEDILLOT
410-345
 185mm, 7 1/4"

14mm

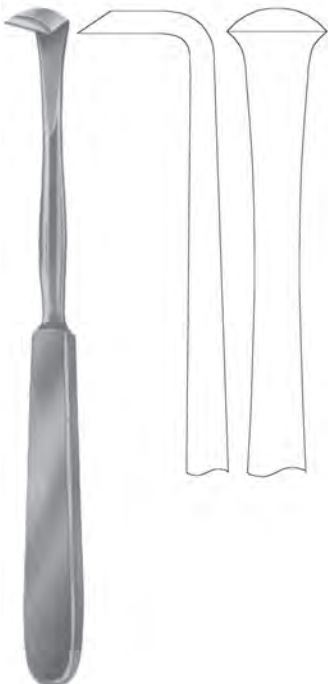

LANGENBECK
410-342
 180mm, 7"

16mm



LANGENBECK
410-340
 190mm, 7 1/2"

15mm

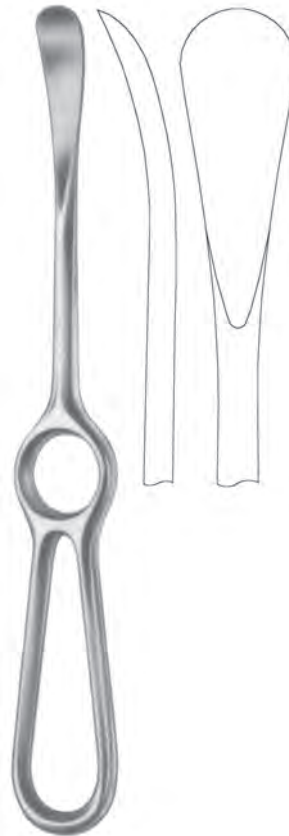

SEDILLOT
410-346
 210mm, 8 1/4"

11mm



MCKISSOCK
410-395
 195mm, 7 3/4"

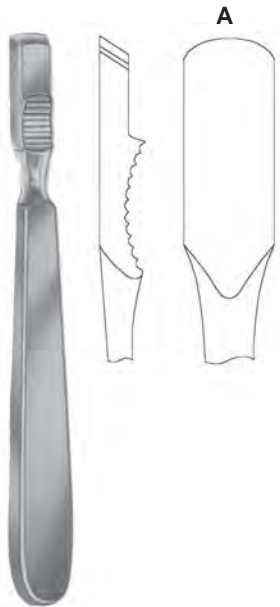

	A mm
410-330-04	4
410-330-06	6
410-330-08	8
410-330-10	10
410-330-12	12
410-330-14	14
410-330-16	16

FARABEU
410-330-04 - 410-330-16
150mm, 6"



FARABEU
410-331-04 - 410-331-16
150mm, 6"



MITCHELLS
410-318
210mm, 8 1/4"

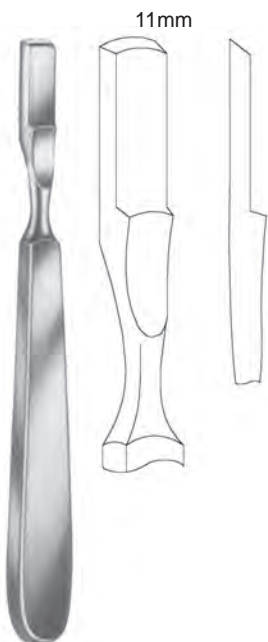

FARABEU-COLLIN
410-336
160mm, 6 1/4"



FARABEU-COLLIN
410-337
160mm, 6 1/4"



410-320
190mm, 7 1/2"



LAMBOTTE
410-350 5mm
410-351 10mm
410-352 15mm
410-353 20mm
410-354 25mm
215mm, 8 1/2"

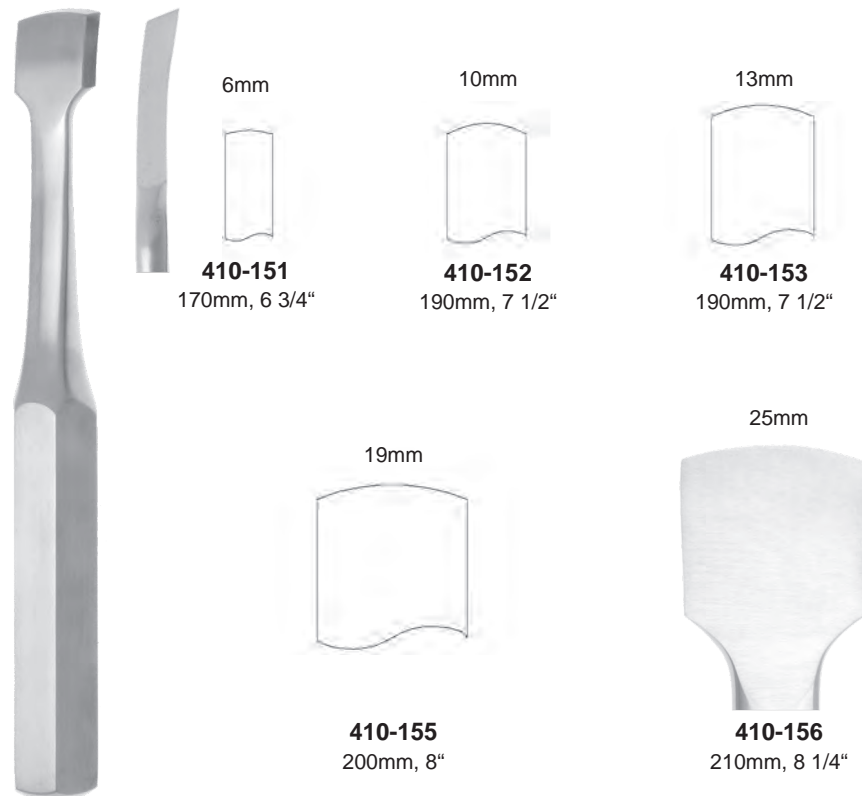

KEY
410-151 - 410-156

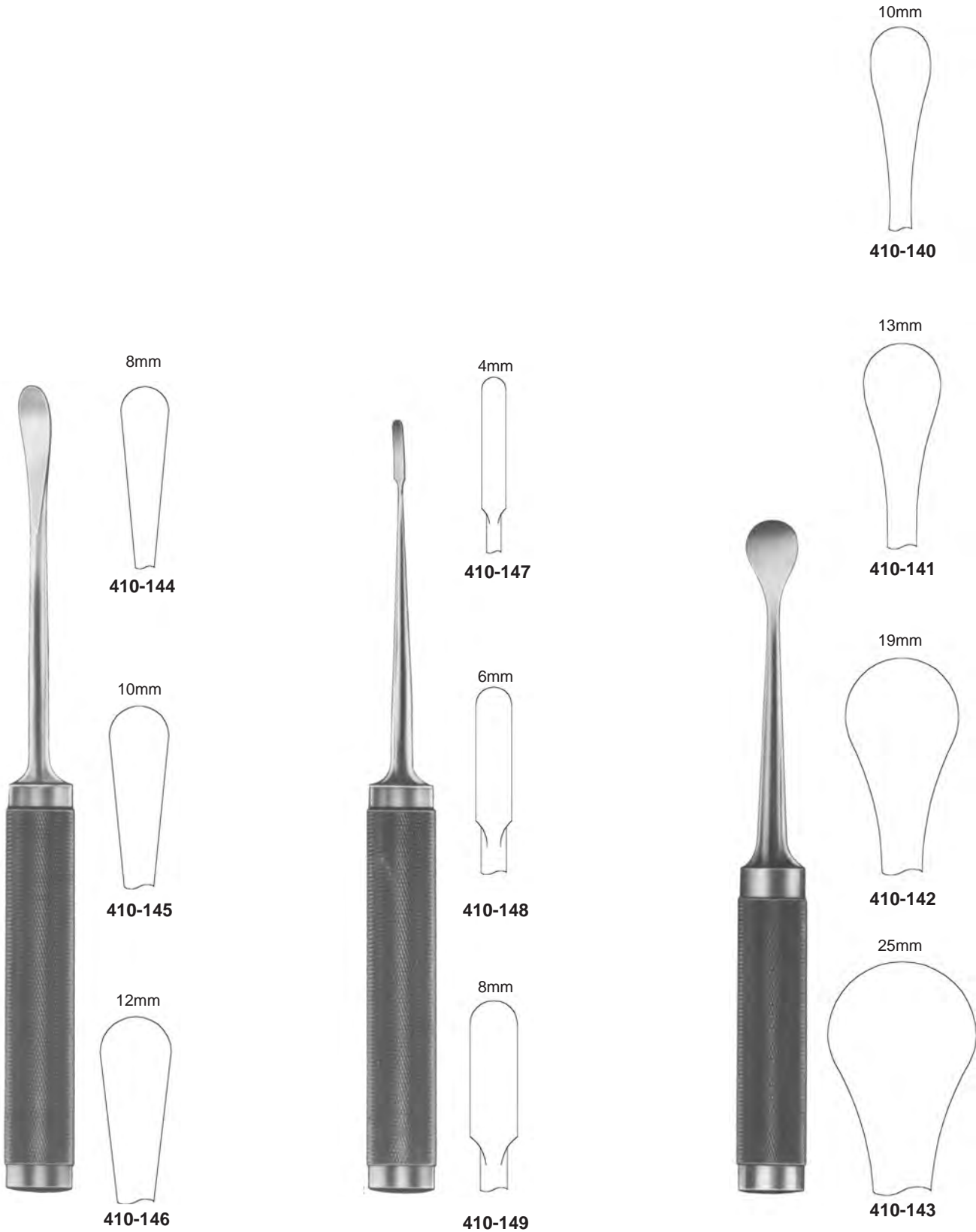

COBB
410-144 8mm
410-145 10mm
410-146 12mm
 280mm, 11"

COBB
410-147 4mm
410-148 6mm
410-149 8mm
 270mm, 10 3/4"

COBB
410-140 10mm
410-141 13mm
410-142 19mm
410-143 25mm
 240mm, 9 1/2"



410-384
190mm, 7 1/2"



410-385
185mm, 7 1/4"



410-382
185mm, 7 1/4"



410-383
185mm, 7 1/4"



410-388
190mm, 7 1/2"



410-380
200mm, 8"



410-381
190mm, 7 1/2"



410-387
200mm, 8"



DOYEN
251-136 **251-137**
240mm, 9 1/2"

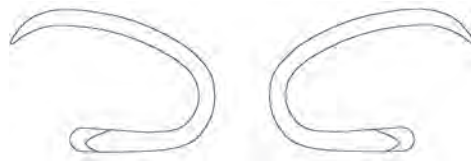

251-132 für Kinder
for children
para niños
pour enfants **251-133**

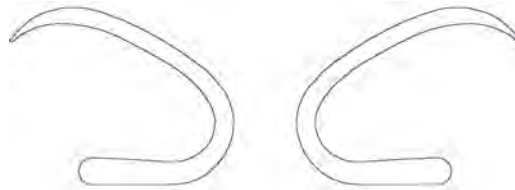

251-134 **251-135**

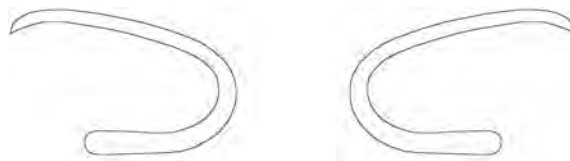

251-136 **251-137**
linksgebogen rechtsgebogen
left curved right curved
curvo a la izquierda curvo a la derecha
courbé à gauche courbé à droite

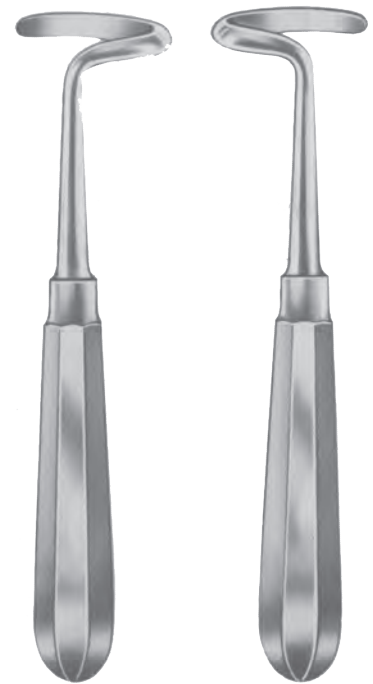

DOYEN
251-132 **251-133**
251-134 **251-135**
175mm, 7"

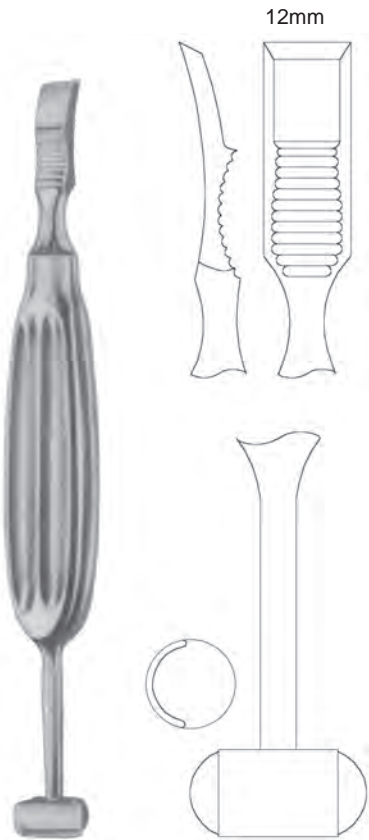

ALEXANDER-FARABEUF
251-122
 210mm, 8 1/4"

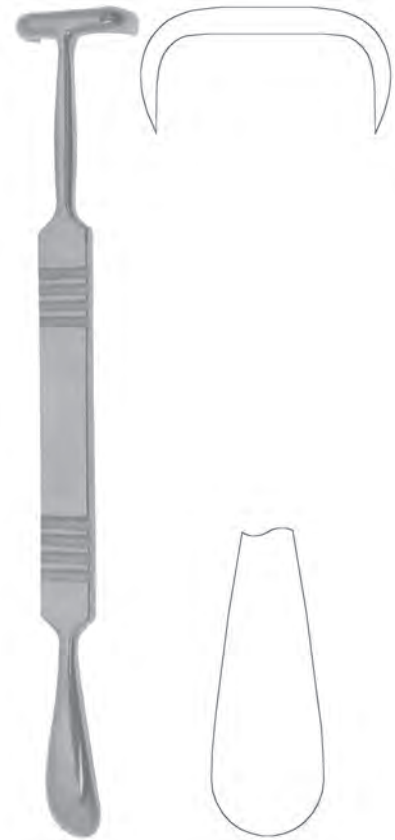

MATSON
251-140
 220mm, 8 3/4"



SEMB
251-100 - 251-107

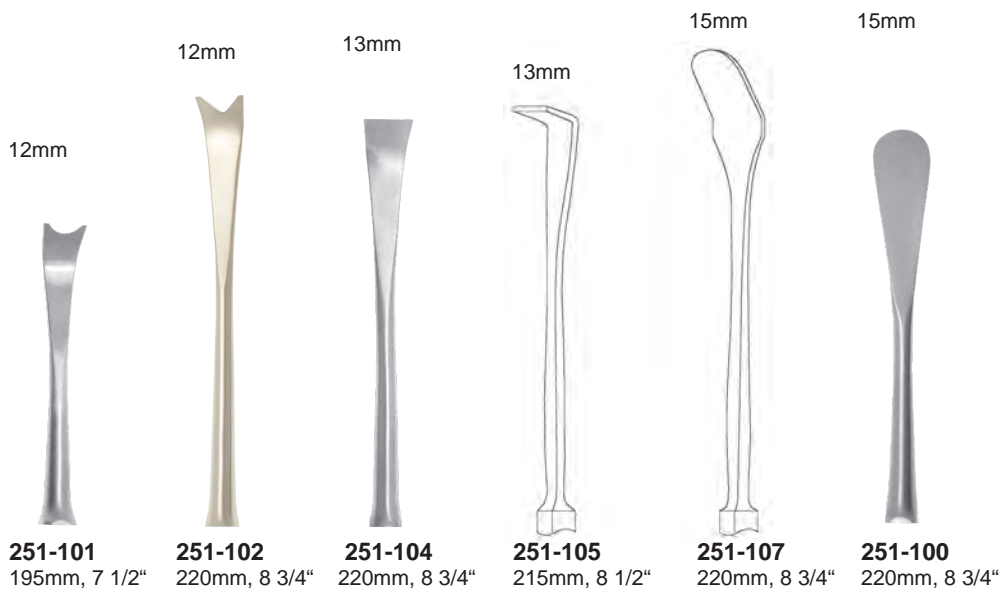

251-101
 195mm, 7 1/2"

251-102
 220mm, 8 3/4"

251-104
 220mm, 8 3/4"

251-105
 215mm, 8 1/2"

251-107
 220mm, 8 3/4"

251-100
 220mm, 8 3/4"

ELCON 410

KNOCHENFEILEN, KNOCHENRASPELN
BONE FILES, BONE RASPS
LIMAS PARA HUESOS, ESCOFINAS PARA HUESO
LIMES A OS, RAPES POUR OS



410-400
245mm, 9 5/8"



**PUTTI
410-410**
270mm, 10 5/8"



**PUTTI
410-411**
300mm, 12"



410-420
280mm, 11"

KNOCHENFEILEN, KNOCHENRASPELN
 BONE FILES, BONE RASPS
 LIMAS PARA HUESOS, ESCOFINAS PARA HUESO
 LIMES A OS, RAPES POUR OS

ELCON
410



410-402
 220mm, 8 3/4"

8mm

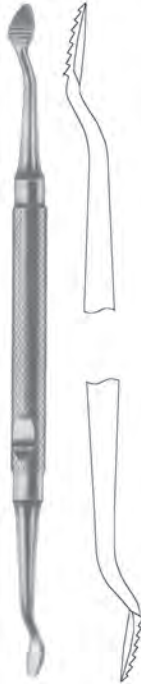

5mm

MILLER
410-432
 180mm, 7"

6mm



4,3mm

MILLER
410-431
 180mm, 7"

6mm

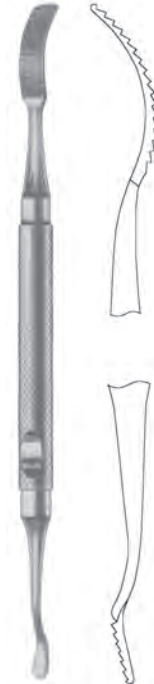

5mm

MILLER
410-430
 180mm, 7"

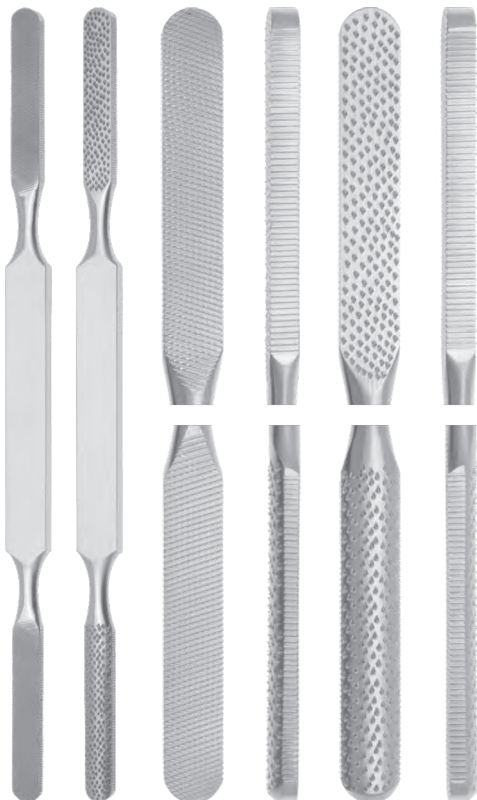

FOMON (KLEINERT KUTZ)
450-548
 210mm, 8 1/4"



FOMON-MASING
450-540
 210mm, 8 1/4"



FOMON-MASING
450-542
 210mm, 8 1/4"



FOMON
450-590 12/14
450-591 16/20
450-592 24/30
450-593 36/44
450-594 52/64
 205mm, 8"

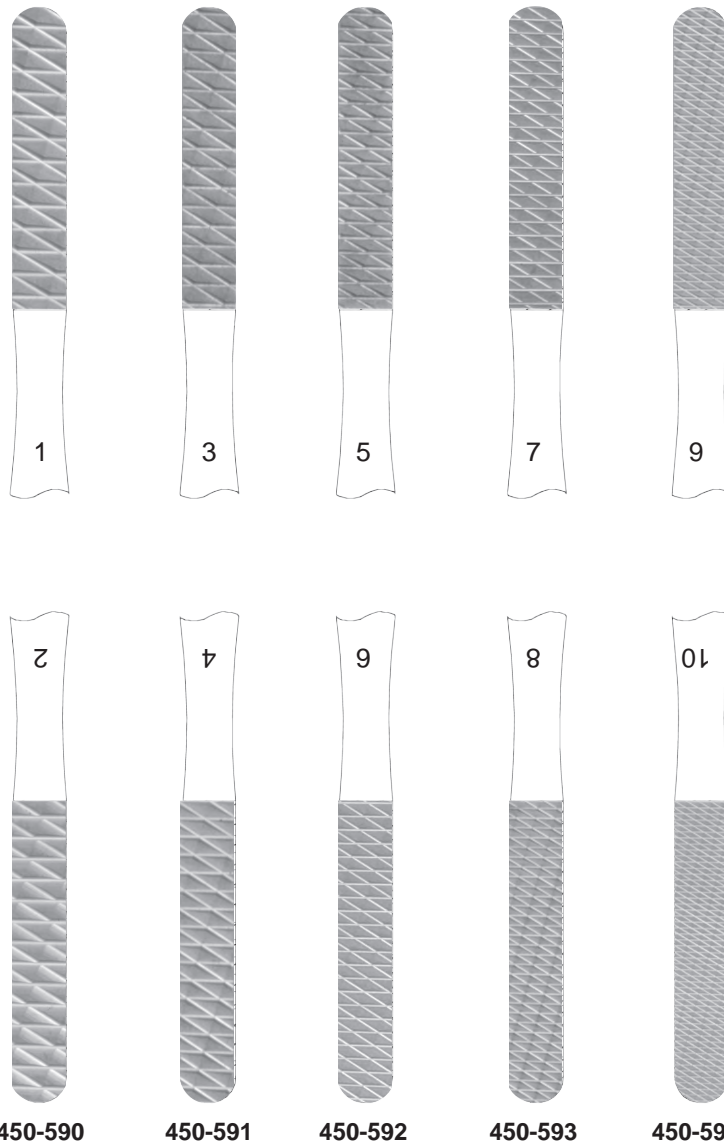

Hartmetalleinlagen
Tungsten carbide inlays
Insertos de carburo tungsteno
Insert de carbure tungstène

- Fig.1 grob / coarse / grueso / grosse
12 Zähne / 12 teeth / 12 dientes / 12 dents
- Fig.2 grob / coarse / grueso / grosse
14 Zähne / 14 teeth / 14 dientes / 14 dents
- Fig.3 grob / coarse / grueso / grosse
16 Zähne / 16 teeth / 16 dientes / 16 dents
- Fig.4 mittel / medium / mediano / moyen
20 Zähne / 20 teeth / 20 dientes / 20 dents
- Fig.5 mittel / medium / mediano / moyen
24 Zähne / 24 teeth / 24 dientes / 24 dents

- Fig.6 mittel / medium / mediano / moyen
30 Zähne / 30teeth / 30 dientes / 30 dents
- Fig.7 fein / fine / fino / fine
36 Zähne / 36 teeth / 36 dientes / 36 dents
- Fig.8 fein / fine / fino / fine
44 Zähne / 44 teeth / 44 dientes / 44 dents
- Fig.9 fein / fine / fino / fine
52 Zähne / 52 teeth / 52 dientes / 52 dents
- Fig.10 fein / fine / fino / fine
62 Zähne / 62 teeth / 62 dientes / 62 dents

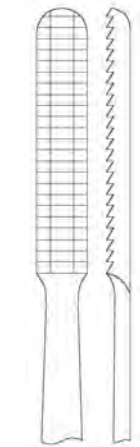

450-518

auf Zug schneidend
 cuts on down stroke
 cortante a tracción
 tranchant à traction

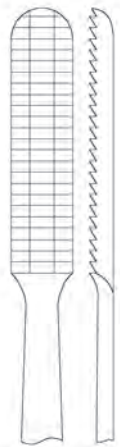

450-519

auf Stoß schneidend
 cuts on up stroke
 cortante a empuje
 tranchant à impact

MALTZ
450-518 - 450-519
 175mm, 7"

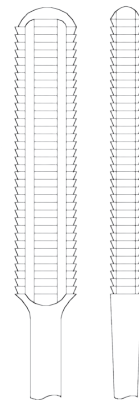

9mm

auf Stoß schneidend
 cuts on up stroke
 cortante a empuje
 tranchant à impact

MALTZ
450-510
 180mm, 7"



9mm



450-530

auf Zug schneidend
 cuts on down stroke
 cortante a tracción
 tranchant à traction



450-531

auf Stoß schneidend
 cuts on up stroke
 cortante a empuje
 tranchant à impact

AUFRICHT
450-530 210mm, 8 1/4"
450-531 210mm, 8 1/4"



8mm

auf Zug schneidend
 cuts on down stroke
 cortante a tracción
 tranchant à traction

COTTLE
450-520
 210mm, 8 1/4"

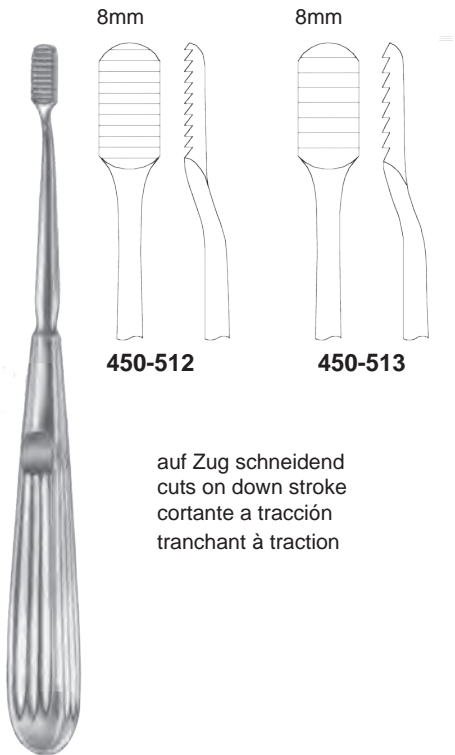

450-512

450-513

auf Zug schneidend
cuts on down stroke
cortante a tracción
tranchant à traction

LEWIS
450-512 - 450-513
180mm, 7"

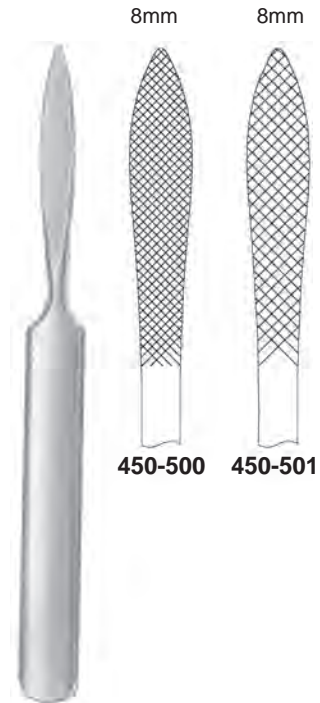

450-500

450-501

JOSEPH
450-500 - 450-501
160mm, 6 1/4"

Ø 5mm Ø 5mm

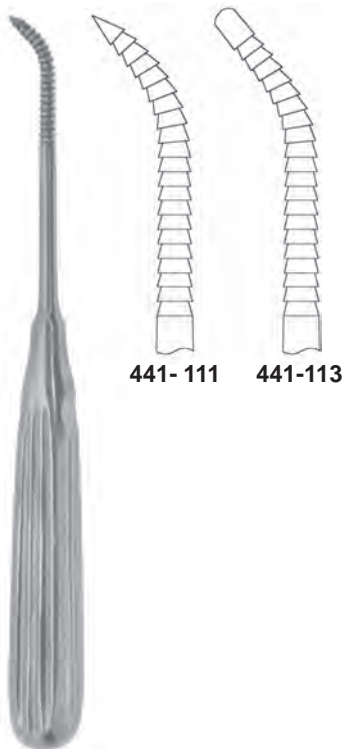

441-111

441-113

WIENER
441-111 - 441-113
180mm, 7"

SCHARFE DOPPELÖFFEL
 BONE CURETTES, DOUBLE ENDED
 CUCHARILLAS DE DOBLE EXTREMO
 CURETTES DOUBLE

ELCON
410

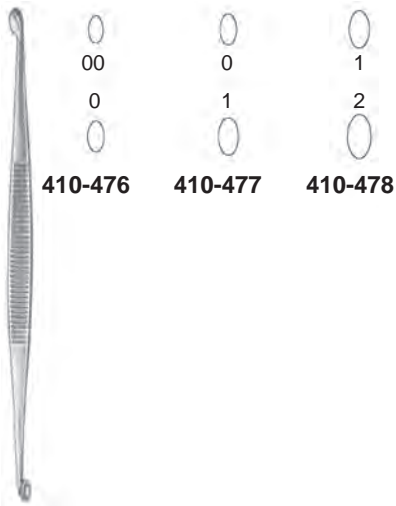

WILLIGER
410-476 Fig. 00/0
410-477 Fig. 0/1
410-478 Fig. 1/2
 135mm, 5 1/4"



HOUSE
 170mm

431-480-01	rund / round / redonda / ronde	Ø1,0mm / Ø1,2mm
431-481-01	oval / oval / oval / ovale	0,8x1,0mm / 1,0x1,2mm
431-481-02	oval / oval / oval / ovale	1,1x1,5mm / 1,3x1,8mm
431-481-03	oval / oval / oval / ovale	1,5x2,2mm / 1,9x2,6mm
431-481-04	oval / oval / oval / ovale	2,3x3,1mm / 2,5x3,3mm
431-482-01	rund / round / redonda / ronde	Ø1,0mm / Ø1,2mm



VOLKMANN
410-480 135mm, 5 1/4"
410-481 145mm, 5 3/4"
410-482 170mm, 6 3/4"



VOLKMANN
410-490
 130mm, 5"



VOLKMANN
410-492
 160mm, 6 1/4"



VOLKMANN
410-494
 200mm, 8"



JACOBSON
410-460
140mm, 5 1/2"



JANSEN
410-462
160mm, 6 1/4"



BARTH
410-498
180mm, 7"



VOLKMANN
410-496
210mm, 8 1/4"



410-485

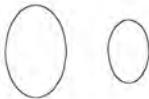

410-486

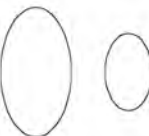

410-487

VOLKMANN
410-485 - 410-487
220mm, 8 5/8"

SCHARFE LÖFFEL
BONE CURETTES
CUCHARILLAS CORTANTES
CURETTES TRANCHANTES

ELCON
410



VOLKMANN
410-540 - 410-549
170mm, 6 3/4"



VOLKMANN
410-5740 - 410-5769 170mm, 6 3/4"
410-5770 - 410-5786 270mm, 10 3/4"

2,8mm



0000
410-540
410-5740
410-5770

3,6mm



000
410-541
410-5741
410-5771

4,4mm



00
410-542
410-5742
410-5772

5,2mm



0
410-543
410-5743
410-5773

6,8mm



1
410-544
410-5744
410-5774

8,5mm



2
410-545
410-5745
410-5775

10mm



3
410-546
410-5746
410-5776

11,5mm



4
410-547
410-5747

13mm



5
410-548
410-5748

14,5mm

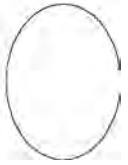

6
410-549
410-5749



BRUNS
410-510 - 410-519
170mm, 6 3/4"

2mm



0000
410-510

3mm



000
410-511

4mm



00
410-512

5mm



0
410-513

6mm



1
410-514

8mm



2
410-515

10mm



3
410-516

12mm

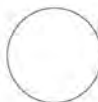

4
410-517

13mm



5
410-518

15mm

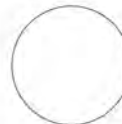

6
410-519

ELCON 410

SCHARFE LÖFFEL
BONE CURETTES
CUCHARILLAS CORTANTES
CURETTES TRANCHANTES



SPRATT
441-290 - 441-297
170mm, 6 3/4"

2,0mm 0000 441-290	2,3mm 000 441-291	3,0mm 00 441-292	3,4mm 0 441-293	4,0mm 1 441-294
	5,5mm 2 441-295	6,2mm 3 441-296	7,0mm 4 441-297	

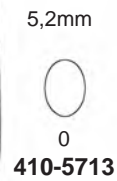
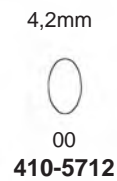
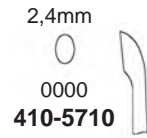

SIMON
410-5711 - 410-5713
240mm, 9 1/2"



2,5mm 000 410-560	3,4mm 00 410-561	4,2mm 0 410-562	5,2mm 1 410-563	6,3mm 2 410-564
7,4mm 3 410-565	8,0mm 4 410-566			

SCHUDE
410-560 - 410-566
170mm, 6 3/4"









2,3mm 00 410-450	3,1mm 0 410-451
4,2mm 1 410-452	5,2mm 2 410-453



WILLIGER
410-450 - 410-453
175mm,

SCHARFE LÖFFEL
BONE CURETTES
CUCHARILLAS CORTANTES
CURETTES TRANCHANTES

ELCON
410

2,5mm	3,0mm	3,5mm	4,0mm	5,0mm	6,0mm	8,0mm	9,0mm	10,5mm
								
000	00	0	1	2	3	4	5	6
410-520	410-521	410-522	410-523	410-524	410-525	410-526	410-527	410-528
410-530	410-531	410-532	410-533	410-534	410-535	410-536	410-537	410-538
341-620	341-621	341-622	341-623	341-624	341-625	341-626	341-627	341-628
341-630	341-631	341-632	341-633	341-634	341-635	341-636	341-637	341-638



SPINAL
341-620 - 341-628
200mm, 8"



SPINAL
341-630 - 341-638
200mm, 8"



BRUNS
410-520 - 410-528
230mm, 9"



BRUNS
410-530 - 410-538
230mm, 9"

ELCON 410

SCHARFE LÖFFEL
BONE CURETTES
CUCHARILLAS CORTANTES
CURETTES TRANCHANTES



CASPAR
414-734 4mm
414-735 5mm
 250mm, 10"
 mit 1 Zahn
 with 1 tooth
 con 1 diente
 avec 1 dent



CASPAR
414-743 3mm
414-744 4mm
 270mm, 10 3/4"
 mit 1 Zahn
 with 1 tooth
 con 1 diente
 avec 1 dent



CASPAR
414-754 4mm
414-755 5mm
414-755 6mm
 220mm, 8 3/4"
 mit 1 Zahn
 with 1 tooth
 con 1 diente
 avec 1 dent



CASPAR
414-643 3,6mm
414-644 4,4mm
414-645 5,2mm
 220mm, 8 3/4"



CASPAR
414-653 3,6mm
414-654 4,4mm
414-655 5,2mm
 220mm, 8 3/4"

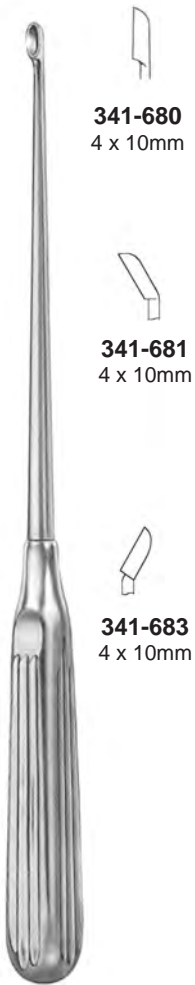

341-680
4 x 10mm

341-681
4 x 10mm

341-683
4 x 10mm

SCOVILLE
341-680 - 341-683
250mm, 10"



410-583
3,6mm

410-584
4,4mm

410-585
5,2mm

410-586
6,8mm

410-583 - 410-586
250mm, 10"



410-593
3,6mm

410-594
4,4mm

410-595
5,2mm

410-596
6,8mm

410-593 - 410-596
250mm, 10"

ELCON 410

HÄMMER
MALLETS
MARTILLOS
MAILLETS



410-618
200mm, 8"

Kopf Ø 30mm
head Ø 30mm
cabeza Ø 30mm
tete Ø 30mm

Gewicht 220g
weight 220g
peso 220g
poids 220g



LUCAE
410-620
190mm, 7 1/2"

Kopf Ø 19mm
head Ø 19mm
cabeza Ø 19mm
tete Ø 19mm

Gewicht 230g
weight 230g
peso 230g
poids 230g

LUCAE
410-621
190mm, 7 1/2"

Kopf Ø 25mm
head Ø 25mm
cabeza Ø 25mm
tete Ø 25mm

Gewicht 260g
weight 260g
peso 260g
poids 260g



410-623
185mm, 7 1/2"

Kopf Ø 25mm
head Ø 25mm
cabeza Ø 25mm
tete Ø 25mm

Gewicht 185g
weight 185g
peso 185g
poids 185g

410-624

Ersatzbacken (Paar), Kunststoff (kein Medizinprodukt)
Spare Facings (pair), plastic (no medical device)
Tapas de repuesto (par), plastico (no es un producto sanitario)
Plaques de rechange (paire), plastique (pas de produit médical)



MEAD
410-625
190mm, 7 1/2"

Kopf Ø 27mm
head Ø 27mm
cabeza Ø 27mm
tete Ø 27mm

Gewicht 320g
weight 320g
peso 320g
poids 320g



410-626

Ersatzbacken (Paar), Kunststoff (kein Medizinprodukt)
Spare Facings (pair), plastic (no medical device)
Tapas de repuesto (par), plastico (no es un producto sanitario)
Plaques de rechange (paire), plastique (pas de produit médical)



DOYEN
410-628
210mm, 8 1/4"

Kopf Ø 30mm
head Ø 30mm
cabeza Ø 30mm
tete Ø 30mm

Gewicht 180g
weight 180g
peso 180g
poids 180g

DOYEN
410-629
210mm, 8 1/4"

Kopf Ø 35mm
head Ø 35mm
cabeza Ø 35mm
tete Ø 35mm

Gewicht 260g
weight 260g
peso 260g
poids 260g



mit Bleifüllung
lead filled
con relleno de plomo
remplissage de plomb

410-604
190mm, 7 1/2"

Kopf Ø 22mm
head Ø 22mm
cabeza Ø 22mm
tete Ø 22mm
Gewicht 165g
weight 165g
peso 165g
poids 165g



HEATH
410-606
185mm, 7 1/4"

Kopf Ø 40mm
head Ø 40mm
cabeza Ø 40mm
tete Ø 40mm
Gewicht 600g
weight 600g
peso 600g
poids 600g

HEATH
410-607
190mm, 7 1/2"

Kopf Ø 45mm
head Ø 45mm
cabeza Ø 45mm
tete Ø 45mm
Gewicht 1000g
weight 1000g
peso 1000g
poids 1000g



mit Bleifüllung
lead filled
con relleno de plomo
remplissage de plomb

410-608
165mm, 6 1/2"

Kopf Ø 20mm
head Ø 20mm
cabeza Ø 20mm
tete Ø 20mm
Gewicht 140g
weight 140g
peso 140g
poids 140g



mit Bleifüllung
lead filled
con relleno de plomo
remplissage de plomb

WILLIGER
410-613
240mm, 9 1/2"

Kopf Ø 28mm
head Ø 28mm
cabeza Ø 28mm
tete Ø 28mm
Gewicht 340g
weight 340g
peso 340g
poids 340g



WILLIGER
410-614
240mm, 9 1/2"

Kopf Ø 30mm
head Ø 30mm
cabeza Ø 30mm
tete Ø 30mm
Gewicht 400g
weight 400g
peso 400g
poids 400g



OMBREDANNE
410-660
250mm, 10"

Kopf Ø 40mm
head Ø 40mm
cabeza Ø 40mm
tete Ø 40mm
Gewicht 550g
weight 550g
peso 550g
poids 550g



PARTSCH
410-616
180mm, 7"

Kopf Ø 22mm
head Ø 22mm
cabeza Ø 22mm
tete Ø 22mm
Gewicht 200g
weight 200g
peso 200g
poids 200g



410-632
265mm, 10 1/2"

Kopf Ø 30mm	Gewicht 450g
head Ø 30mm	weight 450g
cabeza Ø 30mm	peso 450g
tete Ø 30mm	poids 450g



410-634
265mm, 10 1/2"

Kopf Ø 50mm	Gewicht 900g
head Ø 50mm	weight 900g
cabeza Ø 50mm	peso 900g
tete Ø 50mm	poids 900g



410-636
240mm, 9 1/2"

Kopf Ø 37mm	Gewicht 370g
head Ø 37mm	weight 370g
cabeza Ø 37mm	peso 370g
tete Ø 37mm	poids 370g

410-637

Ersatzbacken (Paar), Kunststoff (kein Medizinprodukt)
Spare Facings (pair), plastic (no medical device)
Tapas de repuesto (par), plastico (no es un producto sanitario)
Plaques de rechange (paire), plastique (pas de produit médical)



410-646
260mm, 10 1/4"

Kopf Ø 30mm	Gewicht 450g
head Ø 30mm	weight 450g
cabeza Ø 30mm	peso 450g
tete Ø 30mm	poids 450g



410-648
240mm, 9 1/2"

Kopf Ø 30mm	Gewicht 480g
head Ø 30mm	weight 480g
cabeza Ø 30mm	peso 480g
tete Ø 30mm	poids 480g



410-656
265mm, 10 1/2"

Kopf Ø 30/42mm	Gewicht 650g
head Ø 30/42mm	weight 650g
cabeza Ø 30/42mm	peso 650g
tete Ø 30/42mm	poids 650g

ELCON 410

STÖSSEL, FLACHMEISSEL, OSTEOTOME UND HOHLMEISSEL
TAMPERS, CHISELS, OSTEOTOMES, GOUGES
PUNZONES, CINCELES, OSTEOTOMOS Y GUBIAS
PILONS, CISEAUX-BURINS, OSTEOTOMES ET GOUGES

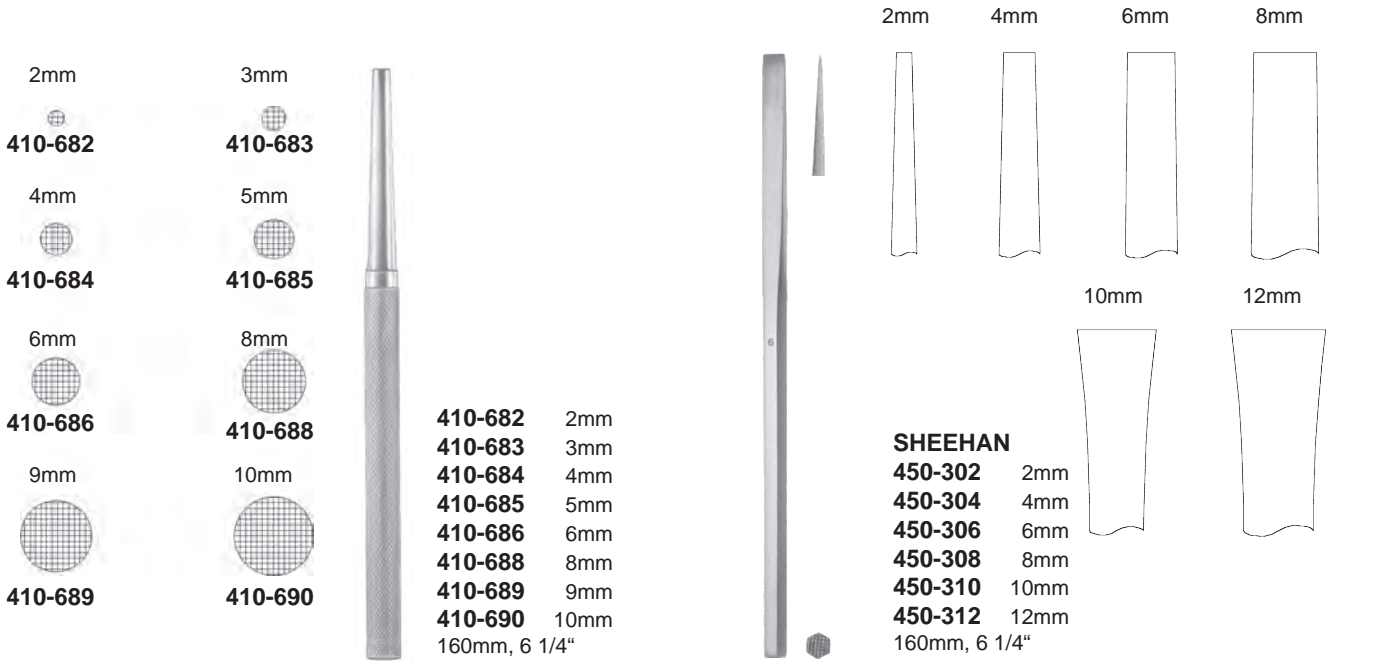

FREER
440-500
165mm, 6 1/2"



FREER
440-501
165mm, 6 1/2"



FREER
440-504
150mm, 6 1/2"



KILLIAN
440-591
160mm, 6 1/4"



KILIAN-CLAUS
440-593
160mm, 6 1/4"

2mm



3mm



4mm



5mm



6mm



PARTSCH

- 410-900** 2mm
 - 410-901** 3mm
 - 410-902** 4mm
 - 410-903** 5mm
 - 410-904** 6mm
- 135mm, 5 1/4"



PARTSCH

- 410-930** 2mm
 - 410-931** 3mm
 - 410-932** 4mm
 - 410-933** 5mm
 - 410-934** 6mm
- 170mm, 6 3/4"

2mm



3mm



4mm



5mm



6mm



PARTSCH

- 410-910** 2mm
 - 410-911** 3mm
 - 410-912** 4mm
 - 410-913** 5mm
 - 410-914** 6mm
- 135mm, 5 1/4"



PARTSCH

- 410-940** 2mm
 - 410-941** 3mm
 - 410-942** 4mm
 - 410-943** 5mm
 - 410-944** 6mm
- 170mm, 6 3/4"



410-960
4mm

410-961
6mm

410-962
8mm

410-963
10mm

410-964
12mm

410-965
14mm

ALEXANDER
410-960 - 410-965
 180mm, 7"



410-970
4mm

410-971
6mm

410-972
8mm

410-973
10mm

410-974
12mm

410-975
14mm

ALEXANDER
410-970 - 410-975
 180mm, 7"

ELCON 410

FLACHMEISSEL, OSTEOTOME
CHISELS, OSTEOTOMES
CINCELES, OSTEOTOMOS
CISEAUX-BURINS, OSTEOTOMES



BUCKLEY

411-2612 2mm
411-2613 3mm
411-2614 4mm
160mm, 6 1/4"

Hohlmeißel
GOUGES
GUBIAS
GOUGES



CARROLL

440-530 3mm
440-532 6mm
440-534 10mm
440-536 12mm
140mm, 5 1/2"



CARROLL

440-540 3mm
440-542 6mm
440-544 10mm
440-546 12mm
140mm, 5 1/2"



LUCAS

410-720-04 4mm
410-720-06 6mm
160mm, 6 1/4"



LUCAS

410-722-03 3mm
410-722-05 5mm
160mm, 6 1/4"



EASTgRINSTEAD

453-103 3mm
453-105 5mm
180mm, 7"



EASTgRINSTEAD

453-113 3mm
453-115 5mm
180mm, 7"

OSTEOTOME
OSTEOTOMES
OSTEOTOMOS
OSTEOTOMES

ELCON 410



MINI-LAMBOTTE

- 411-200 2mm
- 411-201 3mm
- 411-202 4mm
- 411-203 6mm
- 411-204 8mm
- 411-205 10mm
- 411-206 12mm
- 411-207 15mm
- 125mm, 5"



MINI-LAMBOTTE

- 411-210 2mm
- 411-211 3mm
- 411-212 4mm
- 411-213 6mm
- 411-214 8mm
- 411-215 10mm
- 411-216 12mm
- 411-217 15mm
- 170mm, 6 3/4"



LAMBOTTE

- 411-220 4mm
- 411-221 6mm
- 411-222 8mm
- 411-223 10mm
- 411-224 13mm
- 411-225 16mm
- 411-226 18mm
- 411-227 20mm
- 411-228 25mm
- 411-229 30mm
- 411-230 38mm
- 411-231 44mm
- 411-232 50mm
- 240mm, 9 1/2"



LAMBOTTE

- 411-240 4mm
- 411-241 6mm
- 411-242 8mm
- 411-243 10mm
- 411-244 13mm
- 411-245 16mm
- 411-246 18mm
- 411-247 20mm
- 411-248 25mm
- 411-249 30mm
- 411-250 38mm
- 411-251 44mm
- 411-252 50mm
- 240mm, 9 1/2"



COTTLE

- 450-319 2mm
- 450-320 4mm
- 450-321 5mm
- 450-322 6mm
- 450-323 7mm
- 450-324 8mm
- 450-325 9mm
- 450-326 10mm
- 450-328 12mm
- 180mm, 7"



COTTLE

- 450-330 4mm
- 450-332 6mm
- 180mm, 7"

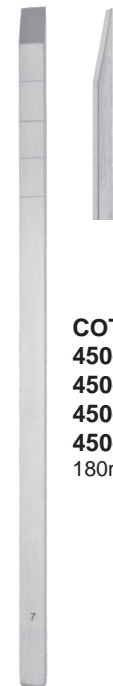

COTTLE

- 450-334 4mm
- 450-335 7mm
- 450-336 9mm
- 450-337 12mm
- 180mm, 7"

6mm

8mm

10mm

12mm

15mm

20mm

25mm

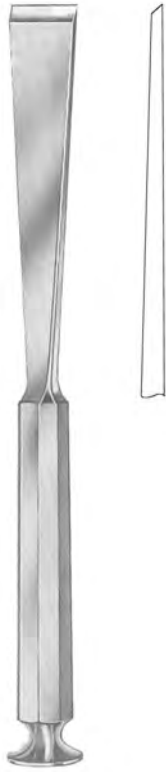
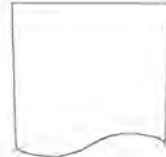

STILLE

410-796 6mm
410-798 8mm
410-800 10mm
410-802 12mm
410-804 15mm
410-806 20mm
410-808 25mm
200mm, 8"

STILLE

410-816 6mm
410-818 8mm
410-820 10mm
410-822 12mm
410-824 15mm
410-826 20mm
410-828 25mm
200mm, 8"

STILLE

410-836 6mm
410-838 8mm
410-840 10mm
410-842 12mm
410-844 15mm
410-846 20mm
410-848 25mm
200mm, 8"

OSTEOTOME, HOHLMEISSEL
 OSTEOTOMES, GOUGES
 OSTEOTOMOS, GUBIAS
 OSTEOTOMES, GOUGES

ELCON
410

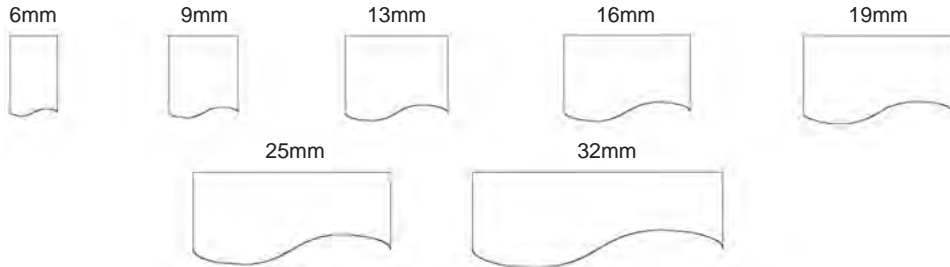

SMITH-PETERSON
411-162-06 6mm
411-162-09 9mm
411-162-13 13mm
411-162-16 16mm
411-162-19 19mm
411-162-25 25mm
411-162-32 32mm
 200mm, 8"

SMITH-PETERSON
411-163-06 6mm
411-163-09 9mm
411-163-13 13mm
411-163-16 16mm
411-163-19 19mm
411-163-25 25mm
411-163-32 32mm
 200mm, 8"

SMITH-PETERSON
411-160-06 6mm
411-160-09 9mm
411-160-13 13mm
411-160-16 16mm
411-160-19 19mm
411-160-25 25mm
411-160-32 32mm
 200mm, 8"

SMITH-PETERSON
411-161-06 6mm
411-161-09 9mm
411-161-13 13mm
411-161-16 16mm
411-161-19 19mm
411-161-25 25mm
411-161-32 32mm
 200mm, 8"

ELCON 410

OSTEOTOME, HOHLMEISSEL
OSTEOTOMES, GOUGES
OSTEOTOMOS, GUBIAS
OSTEOTOMES, GOUGES

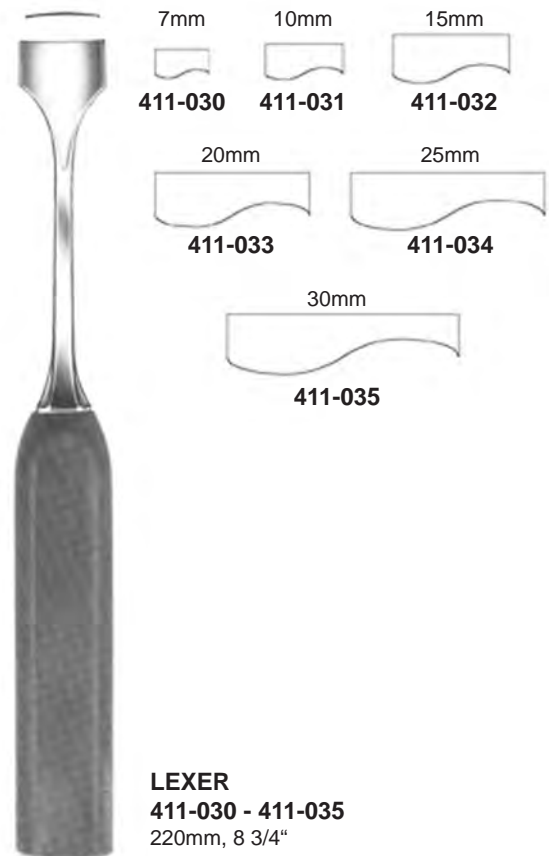
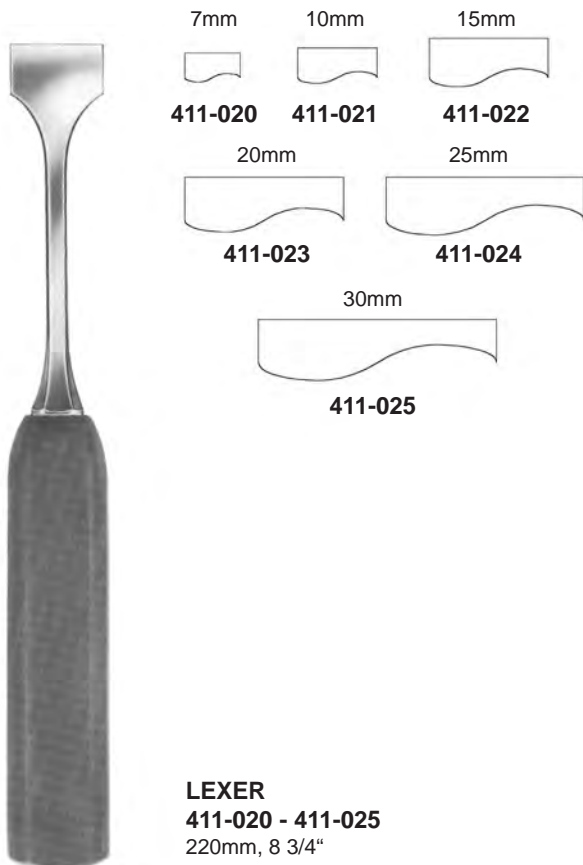
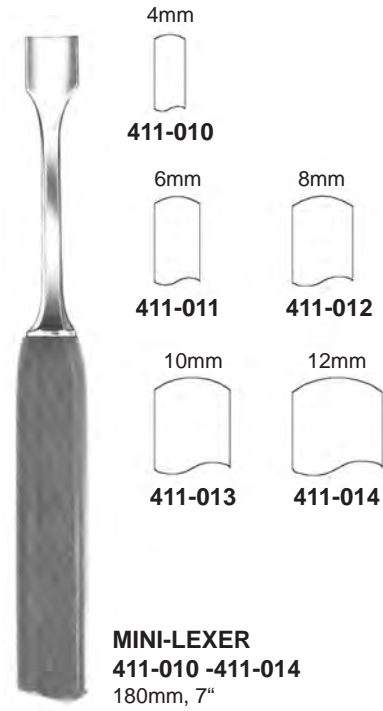
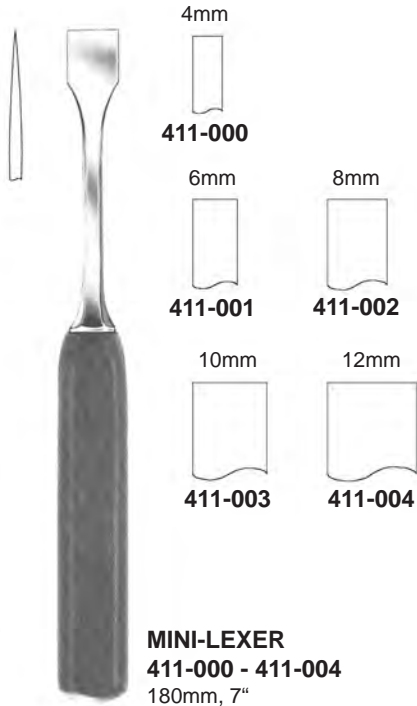

FLACHMEISSEL, HOHLMEISSEL
 CHISELS, GOUGES
 CINCELES, GUBIAS
 CISEAUX-BURIN, GOUGES

ELCON
410



411-2620 4mm
411-2622 6mm
411-2624 10mm
411-2626 15mm
411-2628 20mm,
 200mm,



411-2621 4mm
411-2623 6mm
411-2625 10mm
411-2627 15mm
411-2629 20mm,
 200mm,



5mm



411-050

10mm



411-052

15mm



411-054

LEXER
411-050 - 411-054
 250mm, 10"



5mm



411-051

10mm

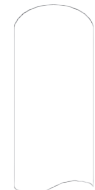

411-053

15mm



411-055

LEXER
411-051 - 411-055
 250mm, 10"



COBB
411-080
280mm, 11"



COBB
411-081
280mm, 11"



COBB
411-082
280mm, 11"



COBB
411-083
280mm, 11"



411-303
130mm, 5 1/4"



411-307
145mm, 5 3/4"



411-308
170mm, 6 3/4"

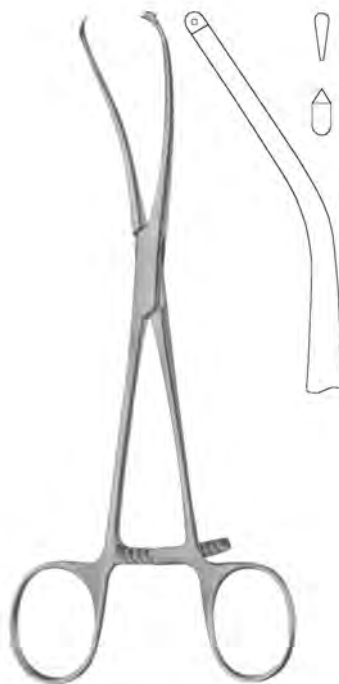

411-3046
170mm, 6 3/4"



411-313
205mm, 8"



DINGMANN
411-310
190mm, 7 ½"



LEWIN
411-330
180mm, 7"



411-309
135mm, 5 ¼"



411-319
140mm, 5 ½"



LANGENBECK
411-322
 210mm, 8 1/4"



FERGUSON
411-324
 210mm, 8 1/4"



411-320
 200mm, 8"

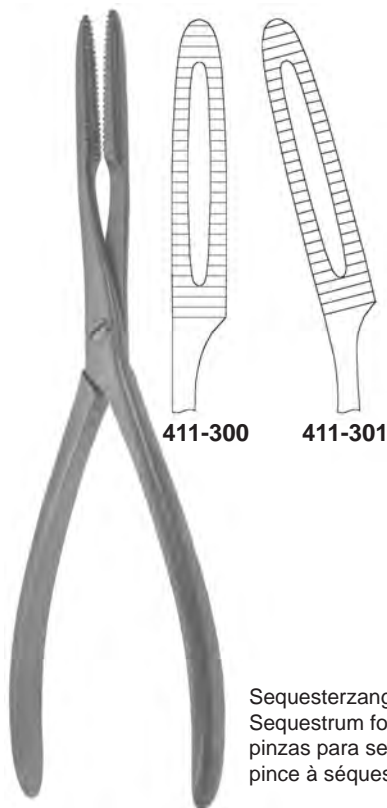

411-300 200mm, 8"
411-301 200mm, 8"

Sequesterzange
 Sequestrum forceps
 pinzas para secuestro
 pince à séquestre



VAN BUREN
411-305
 225mm, 8 3/4"

Sequesterzange
 Sequestrum forceps
 pinzas para secuestro
 pince à séquestre

max. Öffnung 15mm
max. opening 15mm
max. abertura 15mm
max. écartement 15mm



LAHEY
411-316
135mm, 5 ¼"

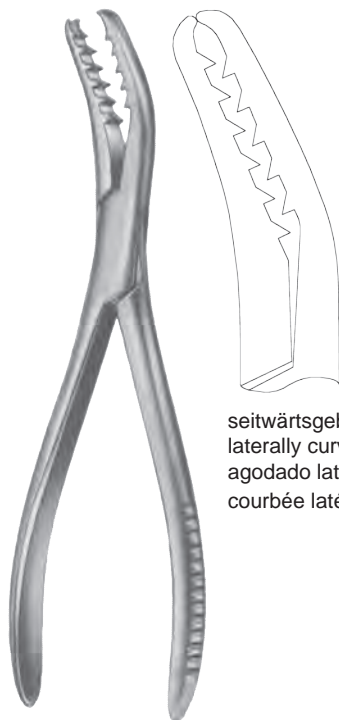

seitwärtsgebogen
laterally curved
agodado lateralmente
courbée latéralement

SEMB
250-900
190mm, 7 ½"



SEMB
250-901
190mm, 7 ½"

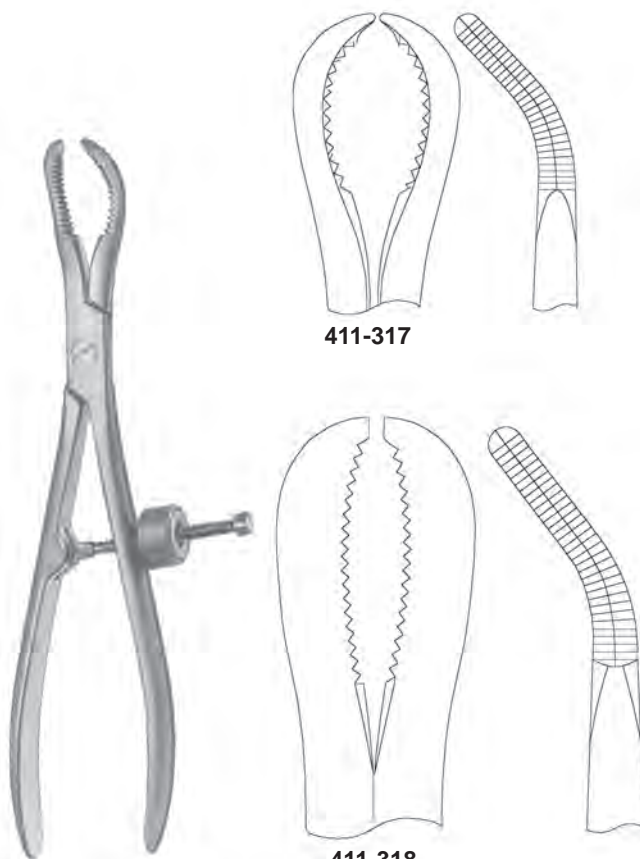

411-317

411-318

411-317 170mm, 6 ¾"
411-318 240mm, 9 ½"

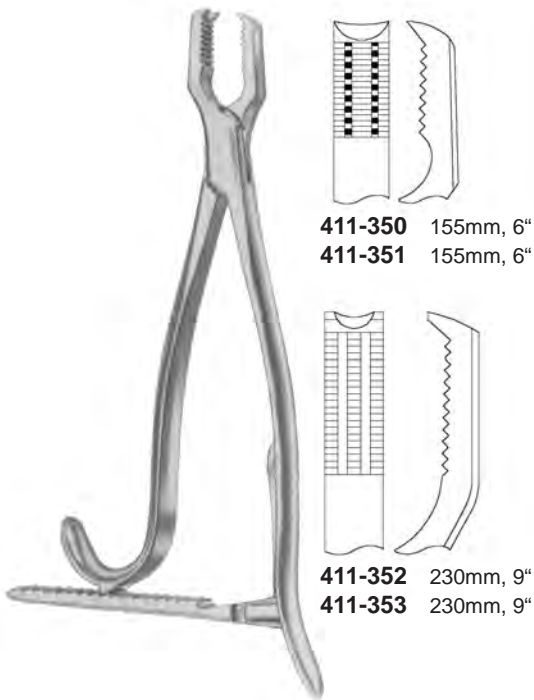

411-350 155mm, 6"

411-351 155mm, 6"

411-352 230mm, 9"

411-353 230mm, 9"

KERN

411-350

411-352

ohne Sperre
 without ratchet
 sin cremallera
 sans crémaillère

411-351

411-353

mit Sperre
 with ratchet
 con cremallera
 avec crémaillère

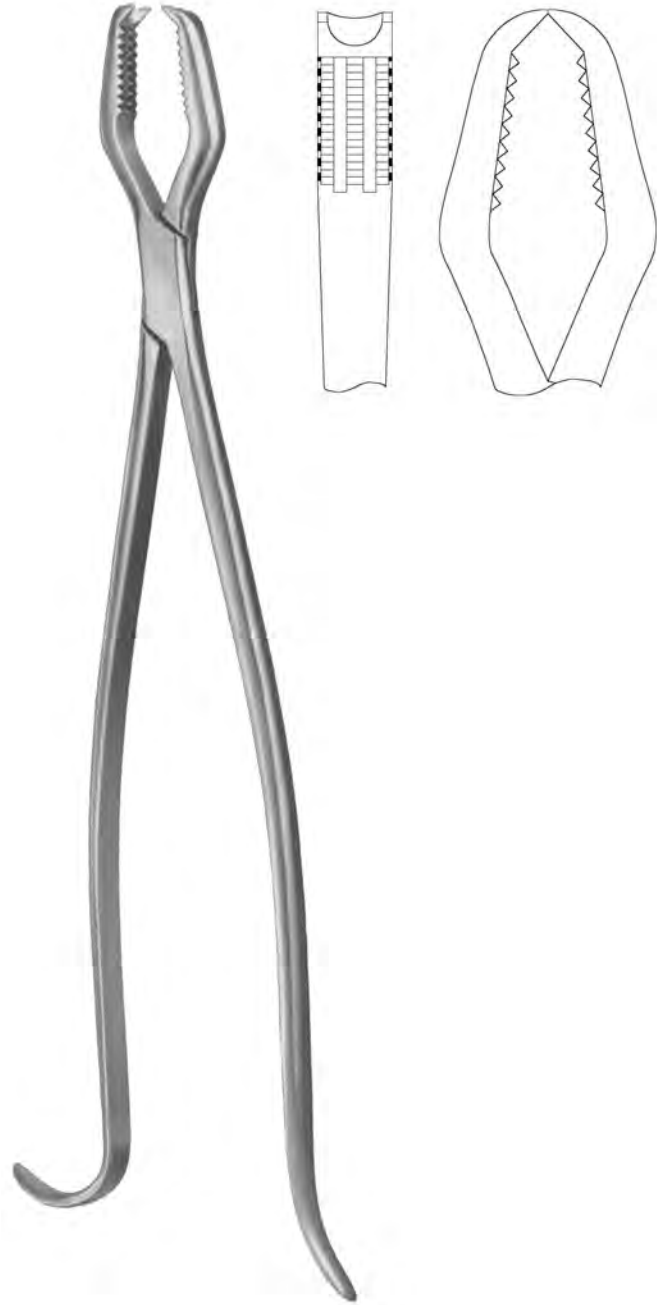

LANE

411-356

330mm, 13"

ohne Sperre
 without ratchet
 sin cremallera
 sans crémaillère

411-357

330mm, 13"

mit Sperre
 with ratchet
 con cremallera
 avec crémaillère

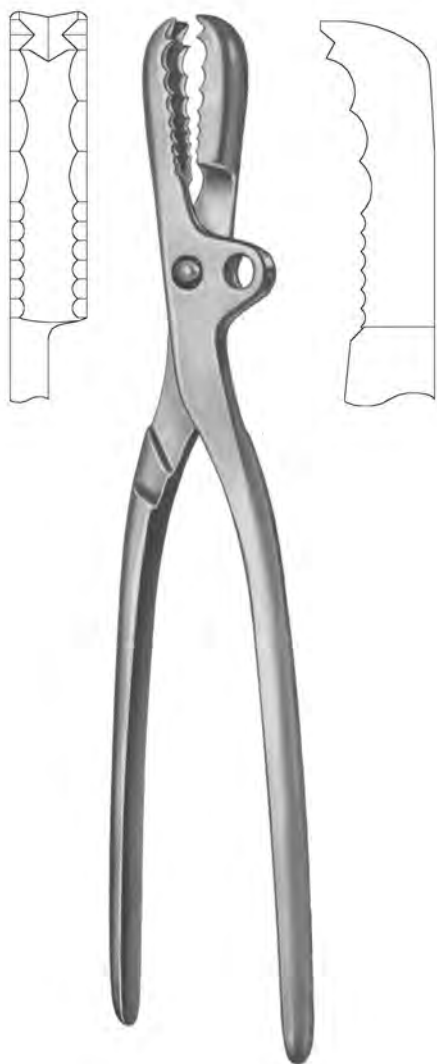

FARABEU

411-341 230mm, 9"

411-342 260mm, 10 1/4"



FARABEU-LAMBOTTE

411-340 260mm, 10 1/4"



411-390
411-391



411-392
411-393

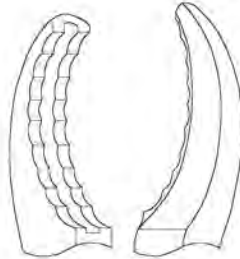

411-394
411-395



ULRICH
411-390 230mm, 9"
411-392 250mm, 10"
411-394 280mm, 11"



ULRICH
411-391 220mm, 8 3/4"
411-393 240mm, 9 1/2"
411-395 270mm, 10 3/4"



HEY-GROVES
411-345 200mm, 8"
411-346 250mm, 10"
411-347 305mm, 12"

ELCON 410

KNOCHENHALTEZANGEN
BONE HOLDING FORCEPS
PINZAS PARA HUESO
DAVIERS PORTE-OS

5mm



411-370

4mm

10mm

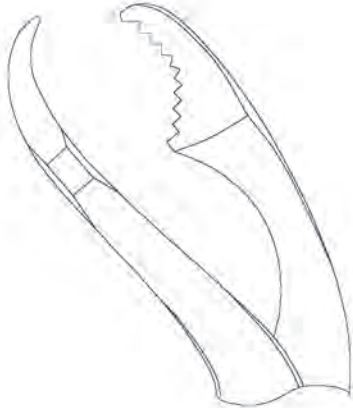

411-371

4,5mm

11mm

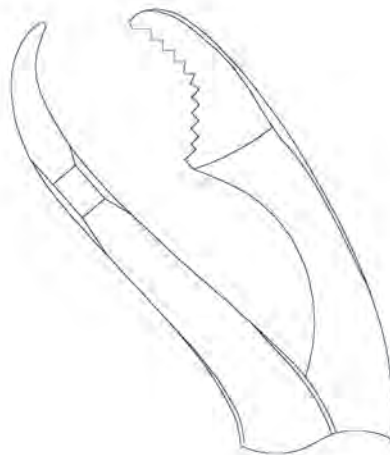

411-372

4,5mm

12mm

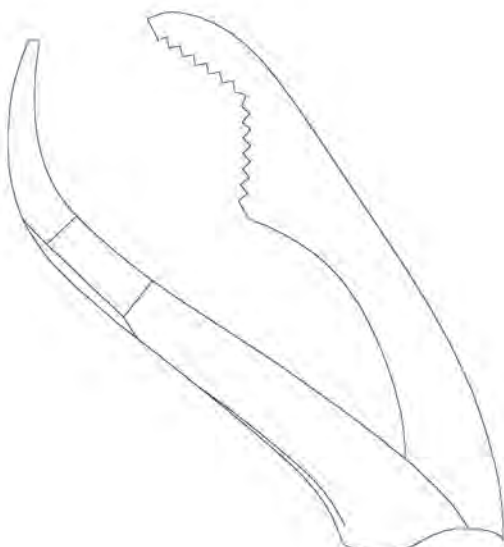

411-373



VERBRUGGE
411-370 175mm, 7"



VERBRUGGE
411-371 255mm, 10"
411-372 265mm, 10 1/2"
411-373 275mm, 10 3/4"



- 411-375** 150mm, 6"
- 411-376** 190mm, 7 1/2"
- 411-377** 240mm, 9 1/2"
- 411-378** 260mm, 10 1/4"
- 411-379** 280mm, 11"

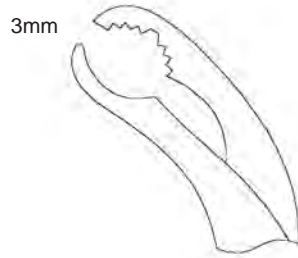

411-375

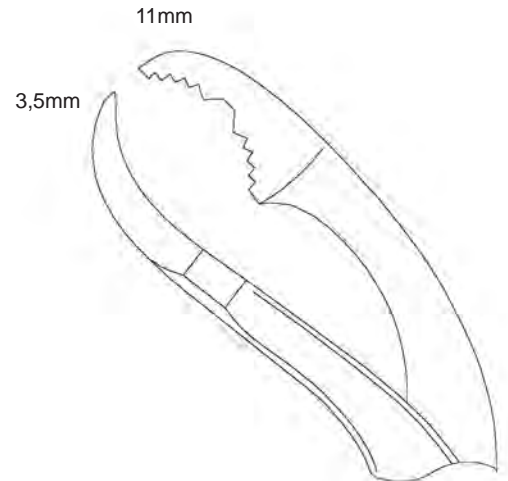

411-378

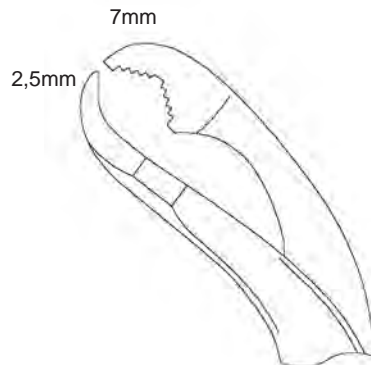

411-376

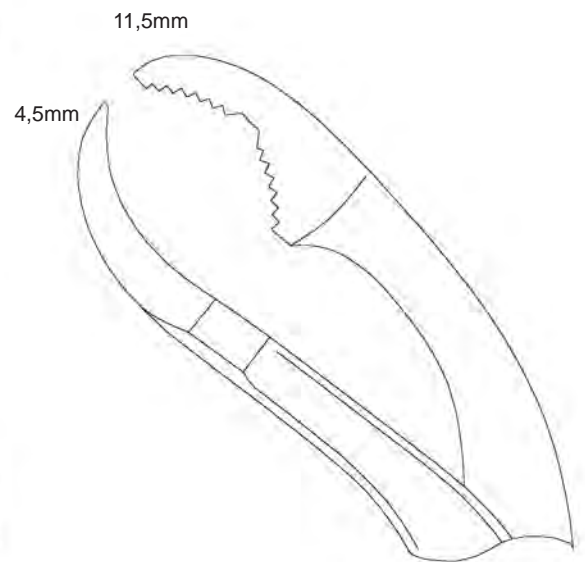

411-379

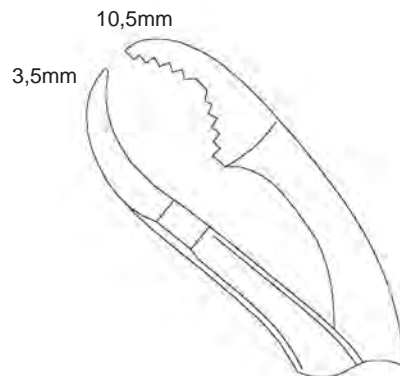

411-377



LOWMAN

- 411-400** 120mm, 4 ¾"
- 411-401** 185mm, 7 ¼"
- 411-402** 200mm, 8"
- 411-403** 220mm, 8 ¾"



beweglich
movable
movible
mobile

LOWMAN-HOGLUND

- 411-411** 185mm, 7 ¼"
- 411-412** 200mm, 8"



**GERSTER
411-450**

Distraktionsklammer für Knochenklemmen.
Traction bar for Lowman bone clamps.
Barra de tracción para pinzas Lowman.
Tracteur pour daviers Lowman.



MINI FRIEDMANN
411-505 125mm, 5"



FRIEDMANN
411-507 135mm, 5 1/4"
411-509 135mm, 5 1/4"



LUER
411-539 145mm, 5 3/4"
411-541 145mm, 5 1/4"
411-543 145mm, 5 3/4"

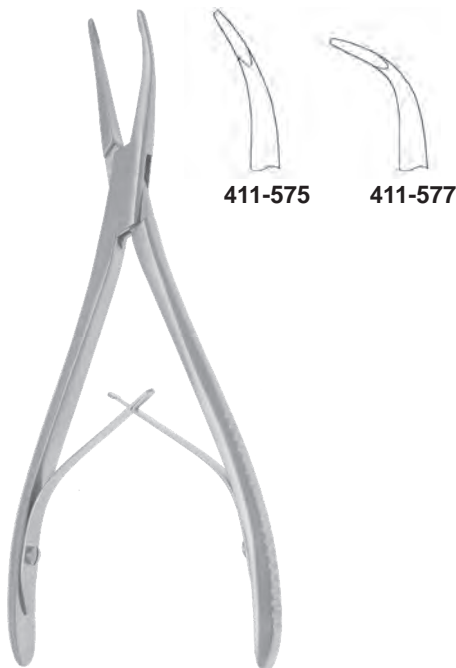

STELLBRINK
411-575 175mm, 6 3/4"
411-577 170mm, 6 3/4"

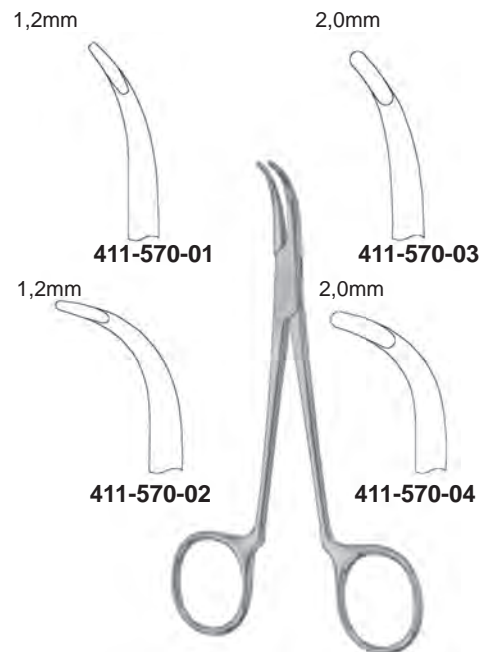

411-570-01 1,2mm
411-570-02 1,2mm
411-570-03 2,0mm
411-570-04 2,0mm
 130mm, 5 1/8"



HARTMANN
411-503 175mm, 6 7/8"

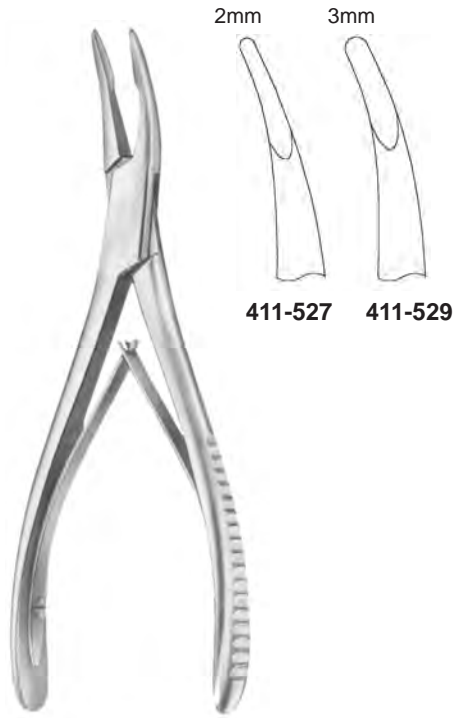

BEYER
411-527 175mm, 6 7/8"
411-529 175mm, 6 7/8"

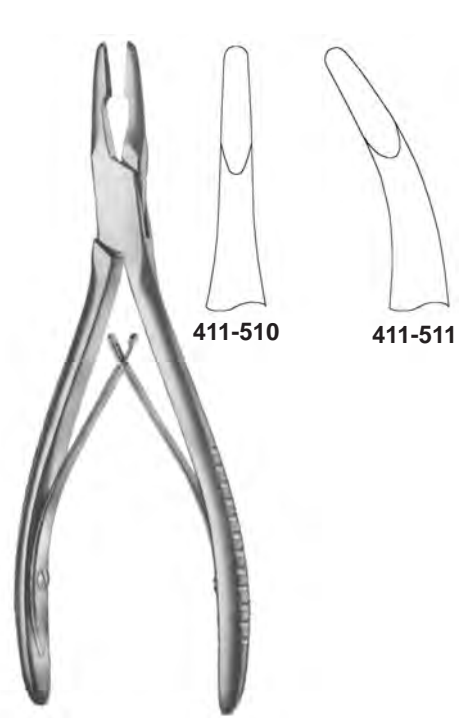

JANSEN
411-510 175mm, 6 7/8"
411-511 175mm, 6 7/8"



BLUMENTHAL
411-565 - 411-569



411-565
155mm, 6 1/8"



411-567
150mm, 6"



411-569
140mm, 5 1/2"

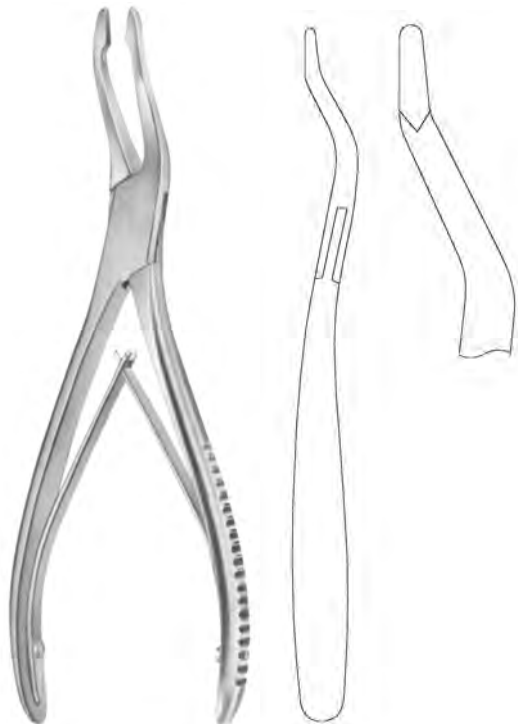

JANSEN
411-513 190mm, 7 1/2"

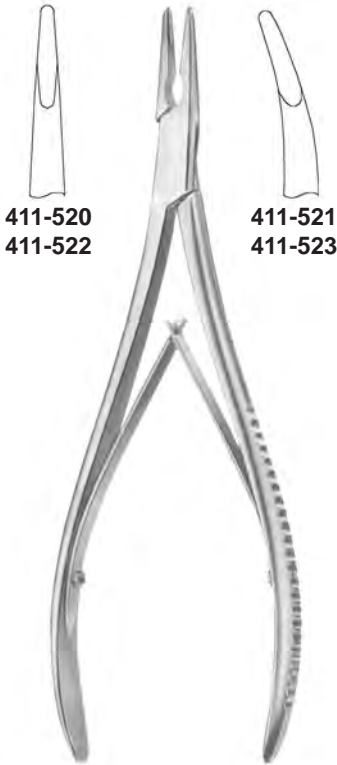

411-520
 411-522

411-521
 411-523

LEMPERT

411-520 160mm, 6 1/4" 411-521
 411-522 190mm, 7 1/2" 411-523



411-583

411-589

MEAD

411-583 165mm, 6 1/2"
 411-589 165mm, 6 1/2"



NORTHFIELD

411-553 210mm, 8 1/4"



8mm
 411-548

8mm
 411-549

LUER

411-548 175mm, 6 7/8"
 411-549 175mm, 6 7/8"



10mm
 411-546

10mm
 411-547

LUER

411-546 180mm, 7"
 411-547 180mm, 7"



ADSON
343-714 205mm, 8"

Schädel Rongeur
Cranial Rongeur
Gubia craneal
Rongeur cranién



OLIVECRONA
411-535 205mm, 8"



CLEVELAND
411-593 135mm, 5 ¼"
411-595 165mm, 6 ½"

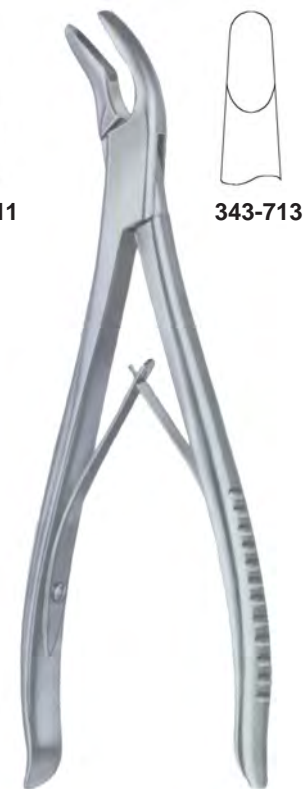

STOOKEY **BACON**
343-711 200mm, 8" **343-713**

Schädel Rongeur
Cranial Rongeur
Gubia craneal
Rongeur cranién

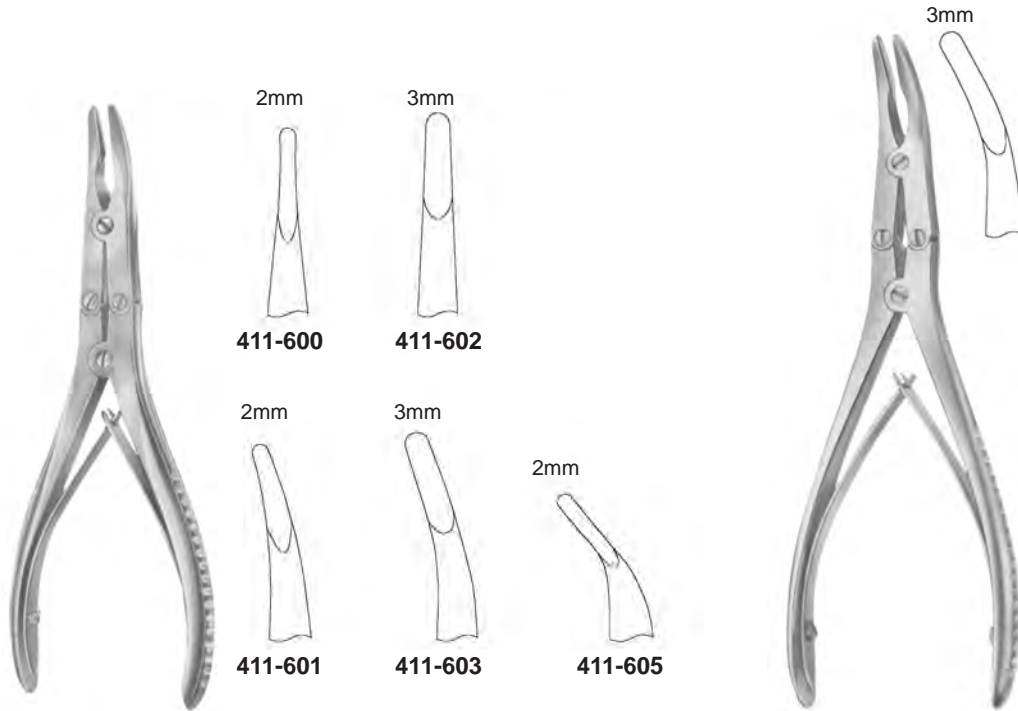

BOEHLER
 411-600 - 411-605
 150mm, 6"

MAYFIELD
 411-611 170mm, 6 3/4"

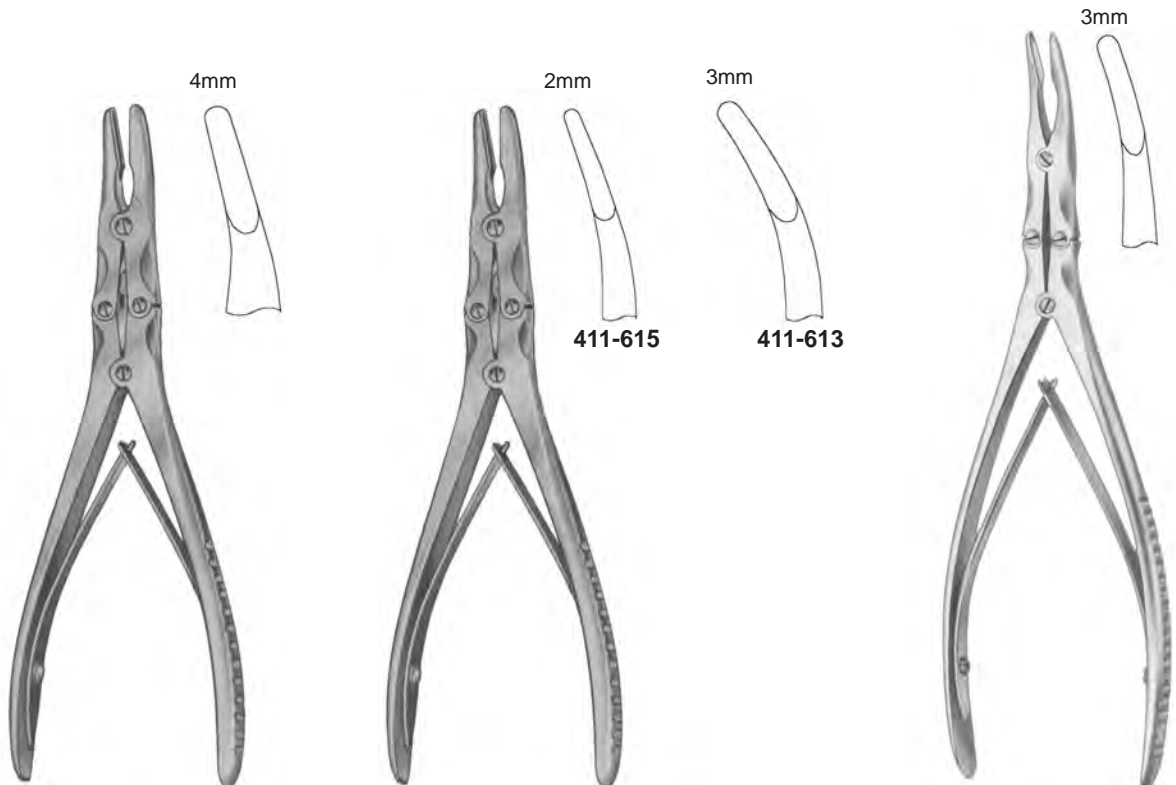

ZAUFAL-JANSEN
 411-617 180mm, 7"

BEYER
 411-613 - 411-615
 180mm, 7"

MARQUART
 411-619 200mm, 8"



4mm



411-620

6mm



411-624

4mm



411-621

6mm



411-625

RUSKIN
411-620 - 411-625
180mm, 7"



5mm



ROETTGEN-RUSKIN
411-631
240mm, 9 1/2"



7mm



411-632

7mm



411-633

RUSKIN-STILLE
411-632-411-633
240mm, 9 1/2"



411-670
 411-672



411-671
 411-673



411-681



411-660



411-661



STILLE LUER
 411-670 230mm, 9" 411-671
 411-672 270mm, 10 1/2" 411-673



SEMB
 411-681 235mm, 9 1/4"



STILLE LUER
 411-660 225mm, 8 3/4" 411-661



STILLE
411-651 230mm, 9"

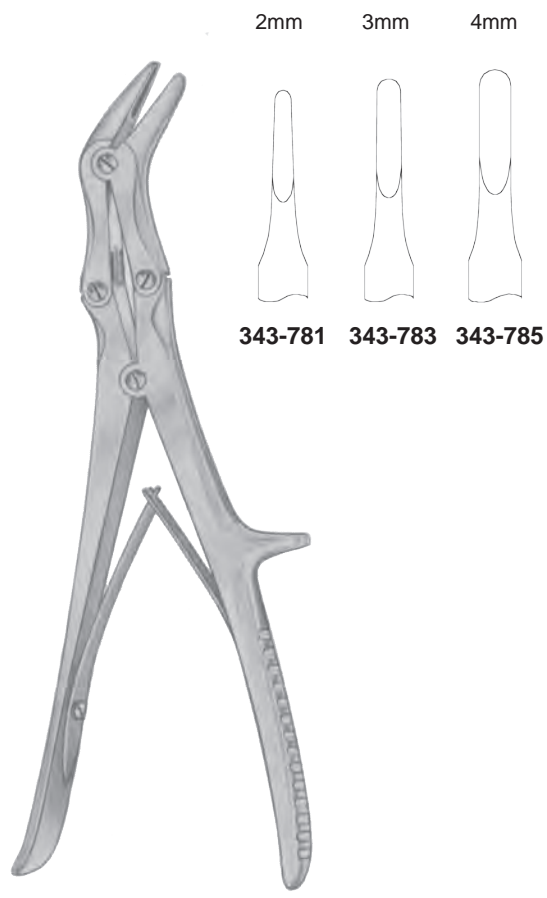

ECHLIN
343-781 - 343-785
230mm, 9"

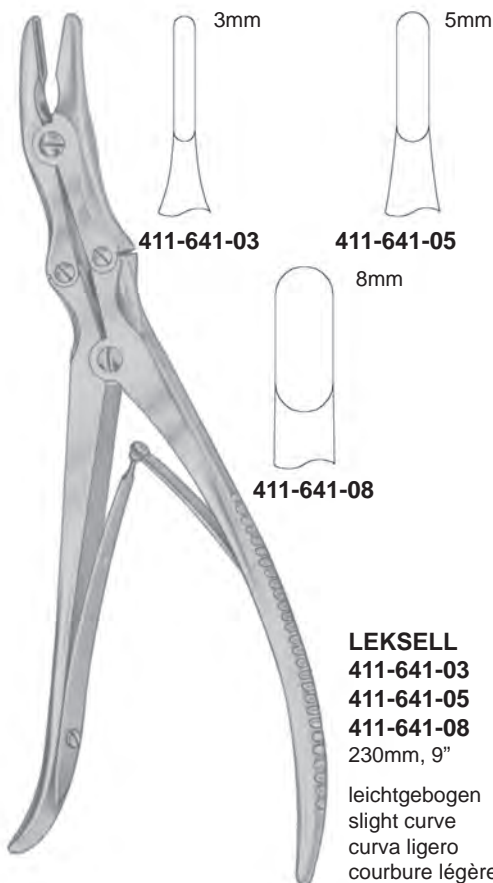

LEKSELL
411-641-03 3mm
411-641-05 5mm
411-641-08 8mm
230mm, 9"
leichtgebogen
slight curve
curva ligero
courbure légère

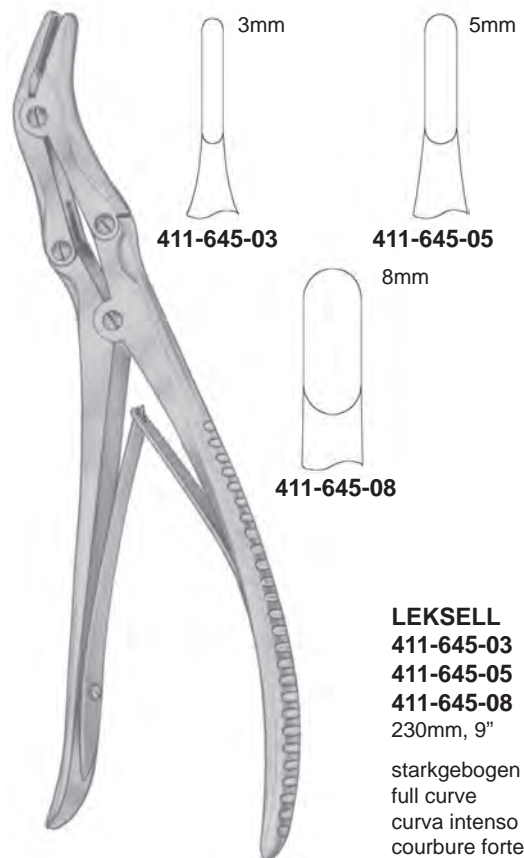

LEKSELL
411-645-03 3mm
411-645-05 5mm
411-645-08 8mm
230mm, 9"
starkgebogen
full curve
curva intenso
courbure forte

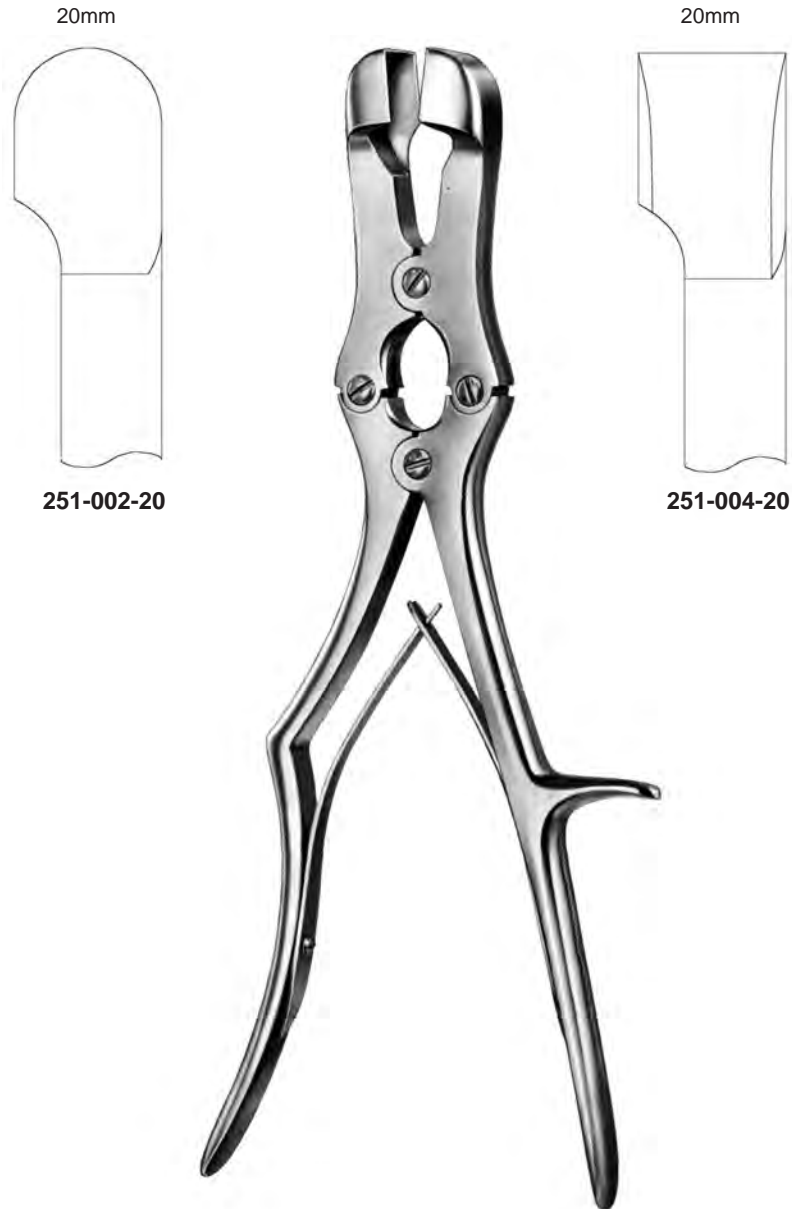

SAUERBRUCH
251-002-20 310mm, 12 1/4" 251-004-20

ELCON 410

KNOCHENSPLITTERZANGEN
BONE CUTTING FORCEPS
PINZAS CORTANTES PARA HUESO
PINCES COUPANTES A OS

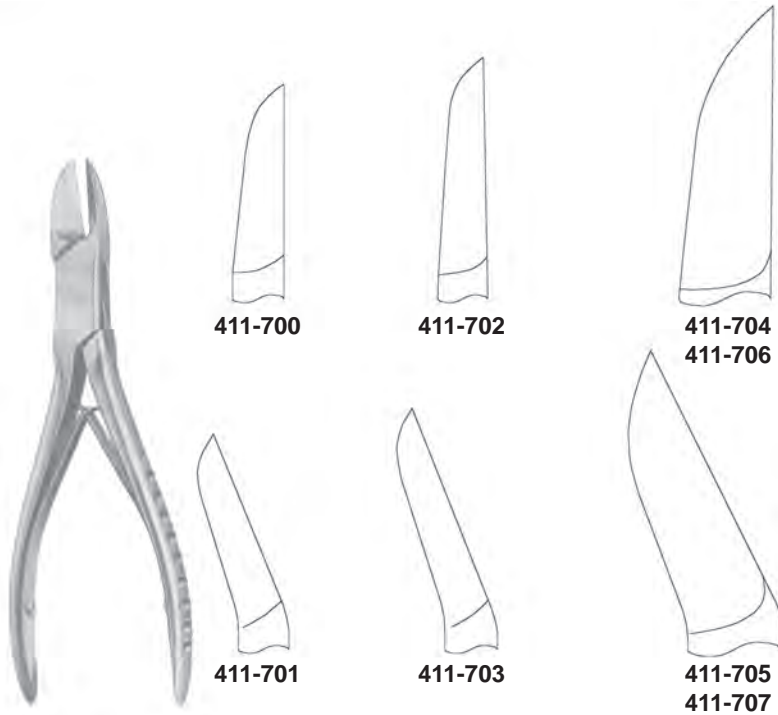

LISTON

- 411-700** 140mm, 5 1/2"
- 411-701** 140mm, 5 1/2"
- 411-702** 170mm, 6 3/4"
- 411-703** 170mm, 6 3/4"
- 411-704** 200mm, 8"
- 411-705** 200mm, 8"
- 411-706** 220mm, 8 3/4"
- 411-707** 220mm, 8 3/4"



LITTAUER-LISTON
411-710
150mm, 6"



CLEVELAND
411-749
150mm, 6"



CLEVELAND
411-751
170mm, 6 3/4"



KAZANJIAN
451-120
185mm, 7 1/4"

KNOCHENSPLITTERZANGEN
BONE CUTTING FORCEPS
PINZAS CORTANTES PARA HUESO
PINCES COUPANTES A OS

ELCON
410



411-800



411-801

BOEHLER
411-800 - 411-801
150mm, 6"



411-810



411-811

MC INDOE
411-810 - 411-811
175mm, 7"



411-822



411-823

RUSKIN-LISTON
411-822 - 411-823
180mm, 7 1/2"



411-820



411-821

ROWLAND
411-820 - 411-821
180mm, 7"



411-830
270mm, 10 3/4"



411-829
235mm, 9 1/4"

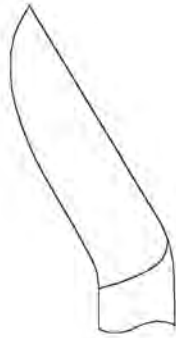

411-831
270mm, 10 3/4"

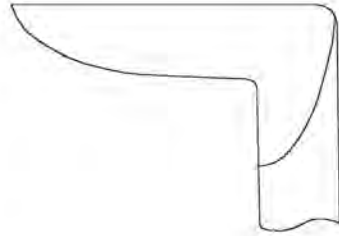

411-833
260mm, 10 1/4"



LISTON
411-829 235mm, 9 1/4"
411-830 270mm, 10 3/4"
411-831 270mm, 10 3/4"



LISTON
411-833
260mm, 10 1/4"

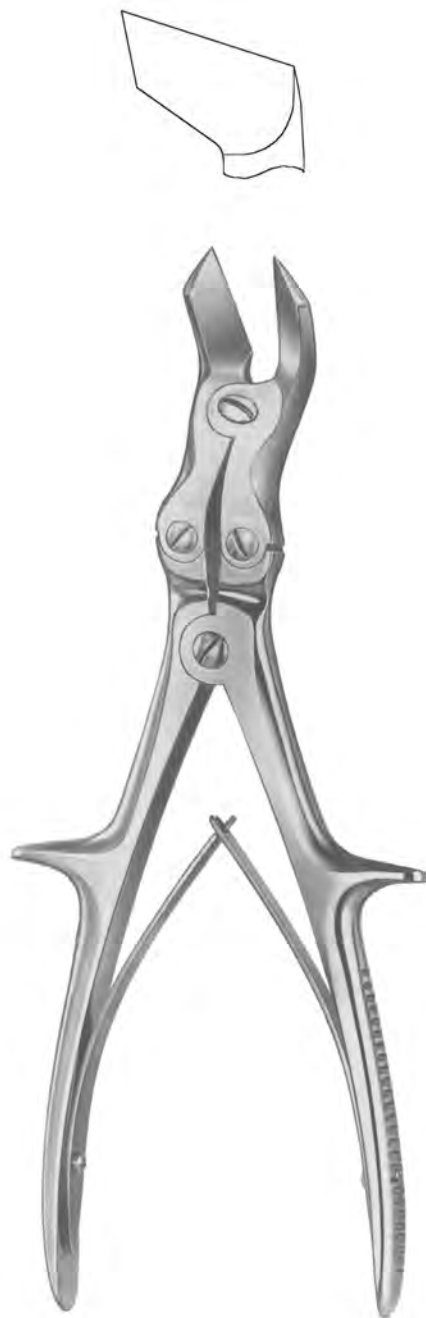

**STILLE-HORSLEY
(TUDOR EDWARDS)**
411-840
260mm, 10 1/4"



SEMB
411-850
240mm, 9 1/2"

ELCON 410

SEHNENFASSZANGEN, SEHNENFLECHTKLEMMEN
TENDON HOLDING AND INTERLACING FORCEPS,
PINZAS PARA COGER Y ENTRECROZAR TENDONES,
PINCES POUR SAISIR ET POUR ENTRELACER LES TENDONS



BRAND
412-180 150mm, 6"
412-182 190mm, 7 1/2"

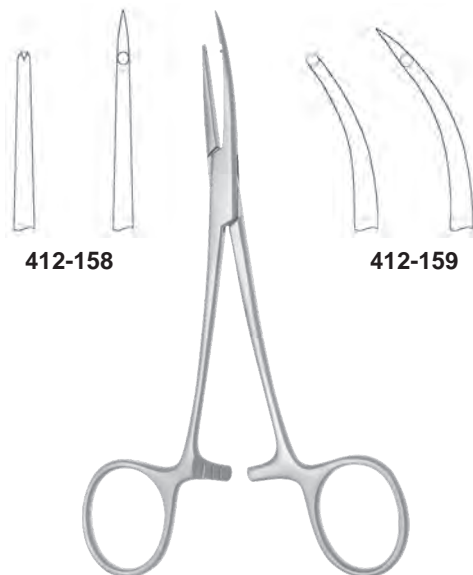

412-158 – 412-159
150mm, 6"



CARROLL
412-127

Nutzlänge 110mm, 4 3/8"
working length 110mm, 4 3/8"
longitud de utilitario 110mm, 4 3/8"
longeur utilitaire 110mm, 4 3/8"



längs durchbohrt
cannulated
barrenado oblongo
perforation axiale

mit Schlüssel
with key
con llave
avec clef

412-538 130mm

Spannweite bis Ø 6,35mm
for shanks up to 6,35mm
apertura hasta Ø 6,35mm
passage jusqu'a Ø 6,35mm



412-586 160mm, 6 1/4"



412-588 140mm, 5 4/8"



PERTHES

412-580 180mm, 7"

412-581 215mm, 8 1/2"



**BUNNEL
412-500**

längsdurchbohrt, Spannweite bis Ø 4mm mit Schlüssel (412-501)
cannulated for shanks up to 4mm with key (412-501)
barrenado oblongo, apertura hasta Ø 4mm on llave (412-501)
passage jusqu'a Ø 4mm, avec clef (412-501)



**RALK
412-520**

längsdurchbohrt, Spannweite bis Ø 6,35mm mit Schlüssel (412-521)
cannulated for shanks up to 6,35mm with key (412-521)
barrenado oblongo, apertura hasta Ø 6,35mm con llave (412-521)
passage jusqu'a 6,35mm, avec clef (412-521)



412-510
275mm, 10 1/4"

Spindel längsdurchbohrt, Spannweite bis 6,00mm
Cannulated spindle for shanks up to 6,00mm
huso barrenado oblongo, apertura hasta Ø 6,00mm
passage de fuseau et mâchoire jusqu'a 6,00mm

2,5mm

3,5mm



412-604 170mm, 6 3/4"
412-606 250mm, 10"

412-600 250mm, 10"
412-601 200mm, 8"

412-602 250mm, 10"
412-603 200mm, 8"

412-608 250mm, 10"

PHILIPS
412-610 250mm, 10"

ELCON 410

STAHLDRAHT, DRAHTUMFÜHRUNGSINSTRUMENTE, DRAHTSPANNER
BONE WIRE, WIRE GUIDES, WIRE TIGHTENER
HILOS DE CERCLAJE, AGUJAS PASA-HILO, TENSOR CIERRA-HILO
FIL POUR CERCLAGE, AIGUILLES PASSE-FILS, TENDEUR SERRE-FIL



gewebeverträglich
tissue compatible
inofensivo para tejido
bien toléré par les tissus

Ømm	Ø gauge	
0,2	31G	413-002
0,3	29G	413-003
0,4	27G	413-004
0,5	25G	413-005
0,6	23G	413-006
0,7	22G	413-007
0,8	21G	413-008
0,9	20G	413-009
1,0	19G	413-010
1,2	18G	413-012
1,5		413-015

Cerclage-Drähte, weich, Ringe zu 10 m
Bone wires, soft, coils of 10 m
Hilos de cerclaje blandos rollos de 10 m
Fil pour cerclage, souple, rouleaux de 10 m



LOUTE
413-100
210mm, 8 1/4"



DEMEL
413-120
280mm, 11"

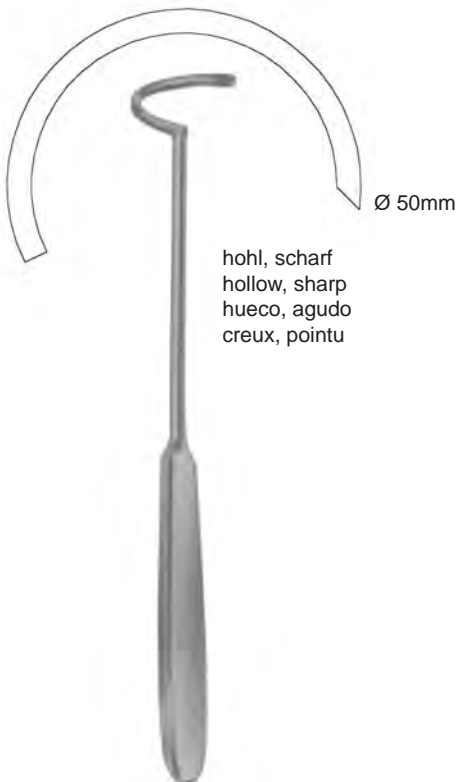

hohl, scharf
hollow, sharp
hueco, agudo
creux, pointu

DEMEL
413-072
230mm, 9"

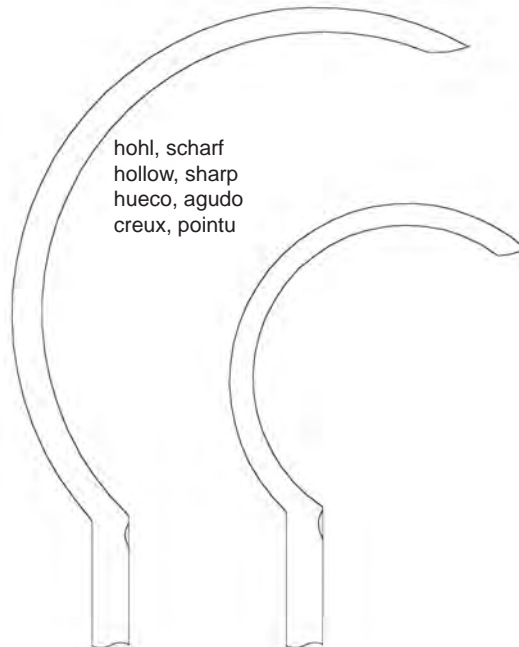

hohl, scharf
hollow, sharp
hueco, agudo
creux, pointu

413-065
Ø 80mm

413-062
Ø 45mm



DEMEL
413-062 240mm, 9 1/2"
413-065 270mm, 10 3/4"

TUNGSTENGRIP DRAHTSPANNZANGE
 TUNGSTENGRIP WIRE TWISTER
 TUNGSTENGRIP PINZAS PARA TORCER ALAMBRE
 TUNGSTENGRIP PINCES A TORCER LE FIL

ELCON
410

TUNGSTENGRIP

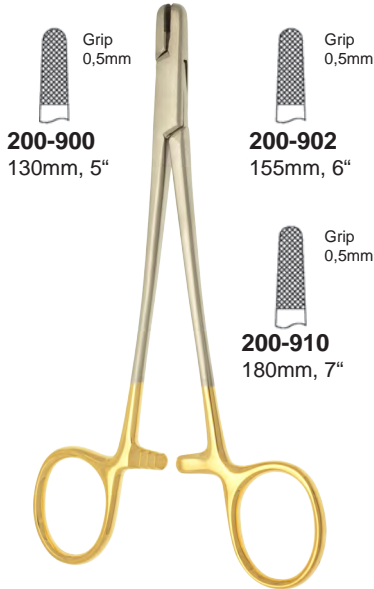

200-900
 130mm, 5"

200-902
 155mm, 6"

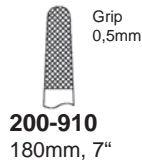

200-910
 180mm, 7"

200-900
200-902
200-910



200-926
 155mm, 6"

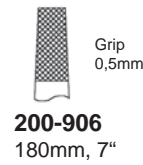

200-906
 180mm, 7"

200-906
200-926



200-904
 155mm, 6"

200-904



200-908
 200mm, 8"

200-908

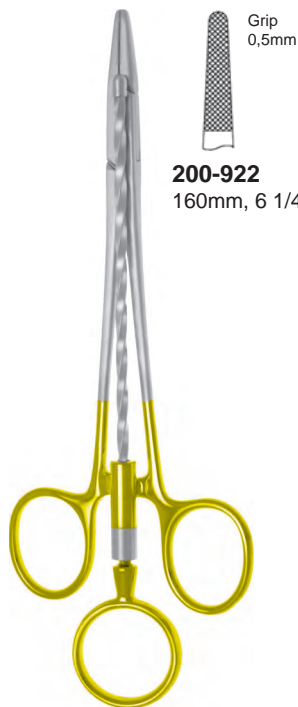

200-922
 160mm, 6 1/4"

CORWIN
200-922 160mm, 6 1/4"

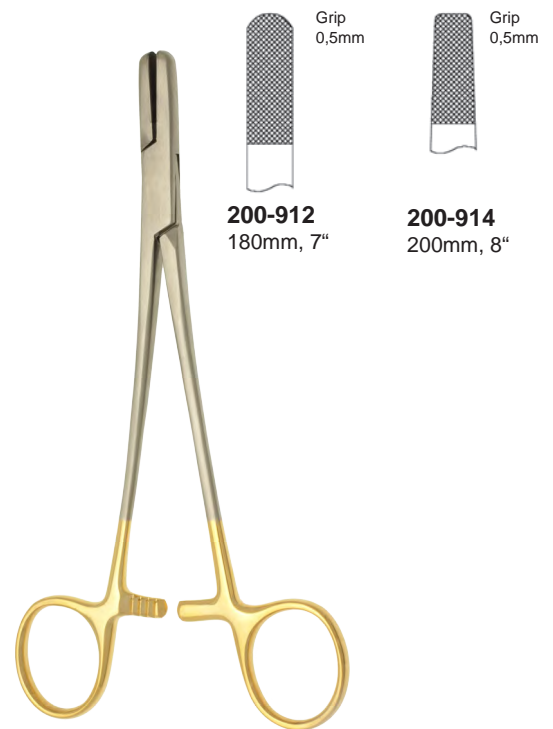

200-912
 180mm, 7"

200-914
 200mm, 8"

200-912 - 200-914

ELCON 410

EXTENSIONSBÜGEL
TRACTION BOWS
EXTRIBOS PARA EXTENSION
EXTRIERIS A EXTENSION

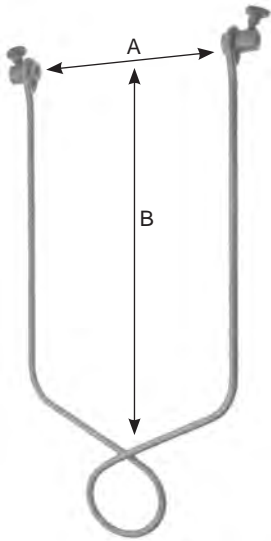

BÖHLER 413-600 90 x 160mm 3 1/2" x 6 1/4" für Arm for arm para brazo pour bras	BÖHLER 413-601 110 x 210mm 4 3/8" x 8 1/4" für Oberschenkel und Knie for thigh and knee para muslo y de la rodilla, pour femur et genou	BÖHLER 413-602 150 x 210mm 6" x 8 1/4" für Oberschenkel und Knie for thigh and knee para muslo y de la rodilla pour femur et genou
---	--	---



413-631



413-661 - 413-663

mit 3 Zughaken
with 3 traction hooks
con 3ganchos de tracción
avec 3 crochets de traction



413-650 - 413-651

STEINMANN

mm	Ø 4mm
80	416-0508
100	416-0510
120	416-0512
140	416-0514
150	416-0515
160	416-0516
180	416-0518
200	416-0520
210	416-0521
250	416-0525
300	416-0530

mit Trokarspitze und 3kant Schaft
aus Implantatstahl DIN 17443

with trocar point and triangular shaft,
implant stainless steel to DIN 17443

con punta trocar y vastago triangular,
para acero inoxidable, conforme a DIN 17443

à pointe triangulaire, extrémité triangulaire,
acier inoxydable, à la norme DIN 17443

KIRSCHNER			
	A		A
413-661	65 - 120mm	413-650	40 - 135mm
413-662	90 - 200mm	413-651	70 - 190mm
413-663	90 - 250mm		

für Kirschner Drähte bis Ø 2,5mm; for Kirschner wires up to 2,5mm diam.
para agujas Kirschner hasta Ø 2,5mm; pour broches Kirschner jusqu'à 2,5mm Ø

TROKARSPITZE, TROCAR POINT
PUNTAS DE TROCAR, POINTE DE TROCARTÉ

Ømm diam.	100mm 4"	150mm 6"	310mm 12 ½"
0,8	419-0038	419-0138	419-0308
1,0	419-0040	419-0140	419-0310
1,2	419-0042	419-0142	419-0312
1,4	419-0044	419-0144	419-0314
1,5	419-0045	419-0145	419-0315
1,6	419-0046	419-0146	419-0316
1,8	419-0048	419-0148	419-0318
2,0	419-0050	419-0150	419-0320
2,2	419-0052	419-0152	419-0322
2,5	419-0055	419-0155	419-0325
3,0	419-0060	419-0160	419-0330

RUNDES ENDE, ROUND SHAFT
CON VASTAGO, REDONDO, A EXTREMITE RONDE

TROKARSPITZE, TROCAR POINT
PUNTAS DE TROCAR, POINTE DE TROCARTÉ

Ømm diam.	150mm 6"	310mm 12 ½"
0,8	419-1138	419-1308
1,0	419-1140	419-1310
1,2	419-1142	419-1312
1,4	419-1144	419-1314
1,5	419-1145	419-1315
1,6	419-1146	419-1316
1,8	419-1148	419-1318
2,0	419-1150	419-1320
2,2	419-1152	419-1322
2,5	419-1155	419-1325
3,0	419-1160	419-1330

MIT FLACHEM ENDE, WITH FLAT SHAFT
CON TERMINO PLANMO, A EXTREMITE PLATE

Sämtliche Bohrdrähte auch in anderen Längen lieferbar!
On request, available in any other length needed!
Entregable en otras medidas!
Livrables, sur demande, dans toute autre longueur!

Packungen zu je 10 Stück.
packages of 10 pieces.
Paquete de 10 piezas.
Paquets de 10 pièces.

BEIDSEITIG TROKAR, DOUBLE TROCAR POINT
PUNTAS DE TROCAR, DOBLE, POINTE DE TROCARTÉ, DOUBLE

Ømm diam.	100mm 4"	150mm 6"	230mm 9"	310mm 12 ½"
0,8	419-2038	419-2138	419-2208	419-2308
1,0	419-2040	419-2140	419-2210	419-2310
1,2	419-2042	419-2142	419-2212	419-2312
1,4	419-2044	419-2144	419-2214	419-2314
1,5	419-2045	419-2145	419-2215	419-2315
1,6	419-2046	419-2146	419-2216	419-2316
1,8	419-2048	419-2148	419-2218	419-2318
2,0	419-2050	419-2150	419-2220	419-2320
2,2	419-2052	419-2152	419-2222	419-2322
2,5	419-2055	419-2155	419-2225	419-2325
3,0	419-2060	419-2160	419-2230	419-2330

Bohrdrahtspender für Bohrdrähte Ø x Länge
Wire dispenser for wire drills diam.x length
Dispensador para agujas Ø x longitudud
Distributeur pour broches Ø x longueur
Distributore per Ø e lunghezza punta

Ø mm	180mm 7"	330mm 13 ½"
0,8	419-5418-08	419-5433-08
1,0	419-5418-10	419-5433-10
1,2	419-5418-12	419-5433-12
1,4	419-5418-14	419-5433-14
1,6	419-5418-16	419-5433-16
1,8	419-5418-18	419-5433-18
2,0	419-5418-20	419-5433-20
2,2	419-5418-22	419-5433-22
2,5	419-5418-25	419-5433-25

ELCON 410

FLACH- UND KOMBINATIONSZANGEN, DRAHTKNEIFZANGEN
COMBI- FLAT NOSE PLIERS, WIRE CUTTING PLIERS
ALICATES DE PLANO, ALICATES PARA CORTAR ALAMBRE
COMBI-PINCES ET PINCES PLATES, PINCES A COUPER LE FIL



413-177
180mm, 7"

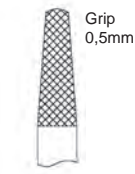

413-178
180mm, 7"

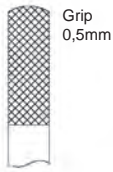

413-179
180mm, 7"



413-170 - 413-174



413-170
145mm, 5 3/4"



413-171
180mm, 7"



413-172
180mm, 7"



413-173
180mm, 7"



413-174
180mm, 7"

TUNGSTENGRIP 413-177 – 413-179

mit Hartmetalleinlagen,
with tungsten carbide inserts
con capas de carburo tungsteno
avec inserts en carbure de tungstène



413-153 – 413-154



413-153
130mm, 5"



413-154
180mm, 7"



413-150
150mm, 6"



413-152
150mm, 6"

FLACHZANGEN
 FLAT NOSE PLIERS
 ALICATES DE PICO PLANO
 PINCES PLATES

ELCON
410



413-158
 140mm, 5 1/2"



413-160



413-161



413-165
 190mm, 7 1/2"



413-134
 185mm, 7 1/4"



413-135
 170mm, 6 3/4"

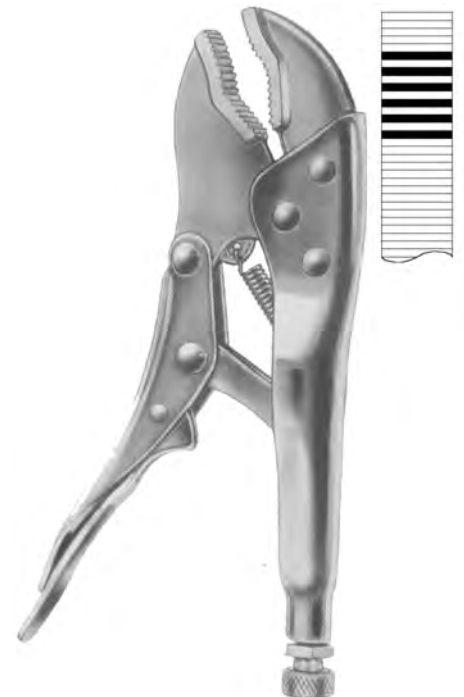

413-130
 185mm, 7 1/4"

ELCON 410

TUNGSTENCUT DRAHTKNEIFZANGEN
TUNGSTENCUT WIRE CUTTING PLIERS
TUNGSTENCUT ALICATES PARA CORTAR ALAMBRE
TUNGSTENCUT PINCES A COUPER LE FIL

TUNGSTENCUT



Kopf- und Seitenschneider
front and lateral cutter
Alicata de corte frontal y lateral
Pince a couper frontale et latérale

$\frac{2,0}{1,5}$

413-192
180mm, 7"

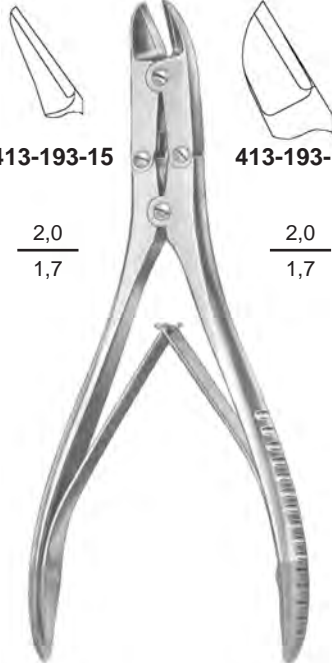

413-193-15

413-193-18

$\frac{2,0}{1,7}$

$\frac{2,0}{1,7}$

413-193-15 155mm, 6 1/4"
413-193-18 180mm, 7"

für weichen Draht bis Ømm
for soft wire up to mm diam.
para blandos hasta Ømm
pour couper les fils doux jusqu'à Ømm

für harten Draht bis Ømm
for hard wire up to mm diam.
para duros hasta Ømm
pour couper les fils durs jusqu'à Ømm



$\frac{0,6}{0,4}$

413-140
125mm, 5"



$\frac{2,0}{1,5}$

413-146
150mm, 6"



$\frac{3,5}{2,5}$

413-186
220mm, 8 3/4"



$\frac{2,8}{2,2}$

413-195
230mm, 8 3/4"

TUNGSTENCUT DRAHTKNEIFZANGEN
TUNGSTENCUT WIRE CUTTING PLIERS
TUNGSTENCUT ALICATES PARA CORTAR ALAMBRE
TUNGSTENCUT PINCES A COUPER LE FIL

ELCON
410

TUNGSTENCUT

Kopfschneider
head cutter
alicate para corte frontal
pince coupante, tranchant frontal



413-202
380mm, 15"
für Kirschner Drähte bis 4mm Ø
for Kirschner wire up to 4mm Ø
para agujas de Kirschner hasta 4mm Ø
pour broches de Kirschner jusqu'à 4mm Ø



413-198 460mm, 18 1/4"
413-199 560mm, 22"
Bolzenschneider zum Abzwicken von Drähten,
Schrauben und Nägel bis 6mm
Cutter for cutting wires, screws and pins up to 6mm
Alicates cortar alambres, tornillos y calvos hasta 6mm
Pince à couper les fils, pivots et clous jusqu'à 6mm



Kompressorium
comprimeter
compressor
compresseur

412-090SS
100mm, 4"

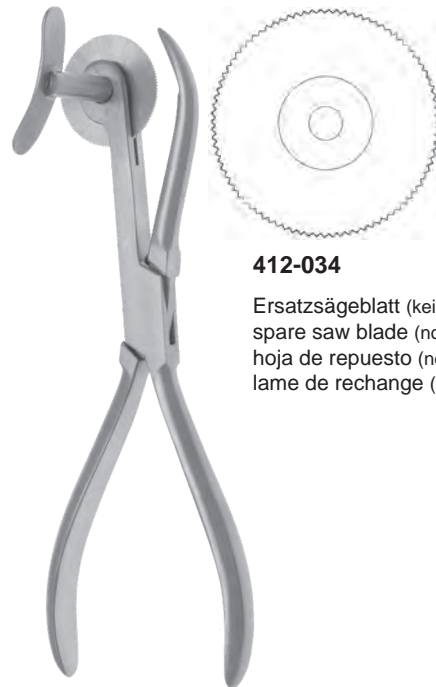

412-034

Ersatzsägeblatt (kein Medizinprodukt)
spare saw blade (no medical device)
hoja de repuesto (no es un producto sanitario)
lame de rechange (pas de produit médical)

412-033
170mm, 6 3/4"



RADOLF
412-010
135mm, 5 1/4"

Nagelausreißzange
nail extracting forceps
pinzas arrance-unas
pince pour arracher les ongles



412-006
130mm, 5 1/4"

Nagelspaltzange
nail splitting forceps
pinzas corta-unas
pince pour fender les ongles

ELCON

MEDICAL INSTRUMENTS GmbH

D - 78532 Tuttlingen Dr. Karl-Storz-Str. 26
Tel: +49 7461 9281-0
info@elcon-medical.de www.elcon-medical.com