

**POWER SYSTEM** for MEDIUM AND LARGE BONE SURGERY  
**MOTEUR** pour CHIRURGIE OS MEDIUM ET LARGE  
**MAQUINA** para CIRUGIA HUESO MEDIO Y LARGO

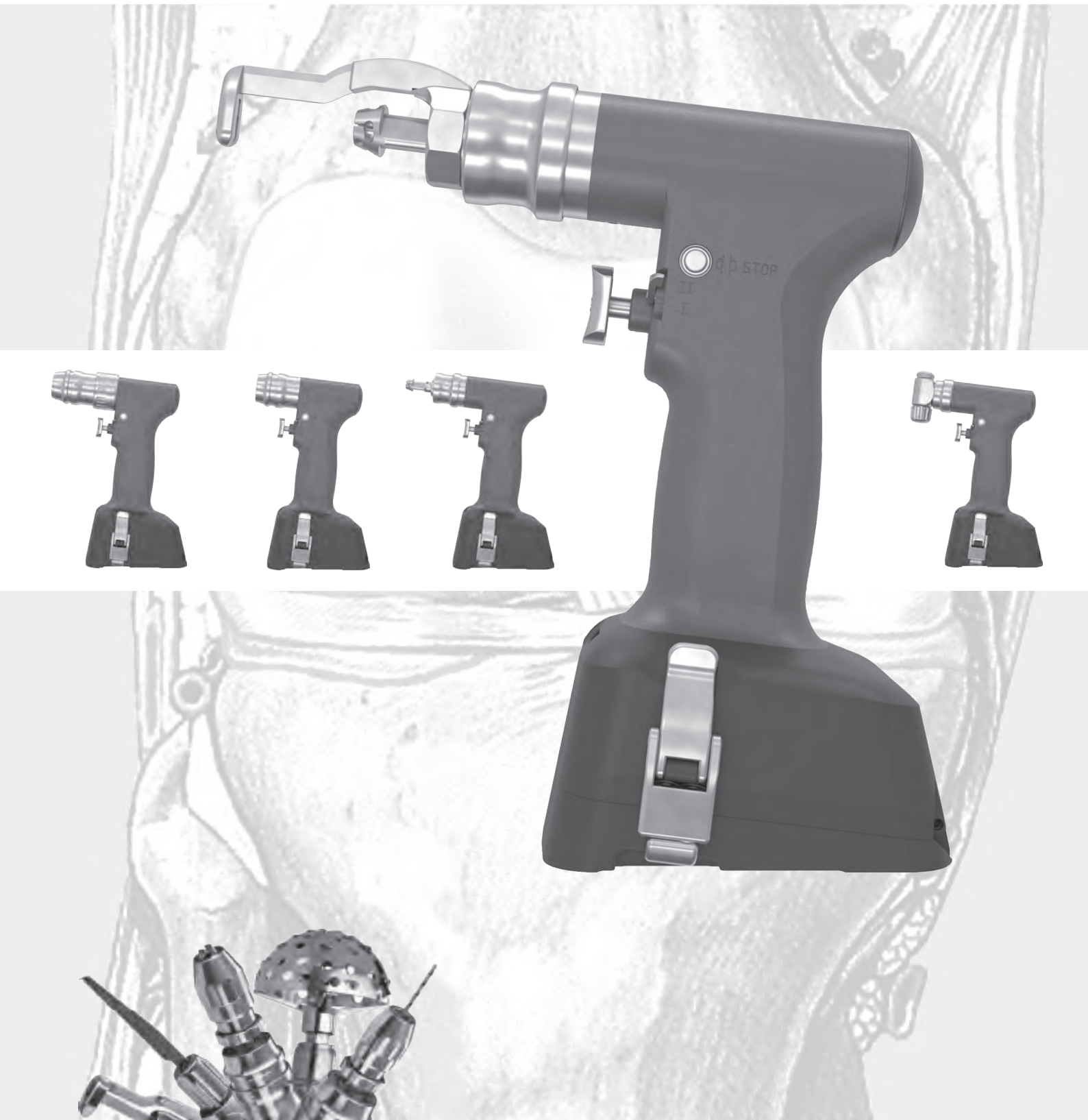

# ELCON 412

*... wide range of top quality instruments*

A revolutionary design separates the non sterile POWER PACK (consisting of motor, electronic parts and battery) from the rest of the system.

By using a sterile funnel, the staff can change the POWER PACK without contaminating the hermetically sealed housing.

The outer housing can be sterilised by means of validated steam sterilisation (ISO 17665). Tests were performed up to a temperature of 143°C for 22 min.



Un design révolutionnaire garantit la séparation du POWER PACK non-stérile (composé de moteur, pièces électroniques et batteries) du reste du système.

En utilisant une douille stérile, le personnel peut échanger le POWER PACK sans contamination du boîtier hermétiquement scellé.

Le boîtier extérieur peut être stérilisé par vapeur (validée d'après ISO 17665). Des tests ont été faits jusqu'à une température de 143°C pendant 22 minutes.

Un diseño revolucionario asegura la separación del POWER PACK non-estéril (conteniendo motor, partes electrónicos y pilas) del resto del sistema.

Utilizando un aplico estéril, el personal puede cambiar el POWER PACK sin contaminar la caja herméticamente cerrada.

La caja exterior puede ser esterilizado a través de esterilización vapor (validado según ISO 17665). Ese fue probado hasta una temperatura de 143°C durante 22 minutos.



# **ELCON**

## MOT 01 - MOT 12

# 412

**POWER TOOLS  
MOTEURS  
MAQUINAS**



Grau dargestellte Artikelnummern bezeichnen „distributed by ELCON“ Produkte  
Article numbers shown in grey indicate „distributed by ELCON“ products  
Los numeros de articulos mostrados en gris indican productos „distribuidos por ELCON“  
Les numéros d'articles affichés en gris indiquent les produits « distribués par ELCON »

412-355 UNIVERSAL DRILL  
412-355 UNIVERSAL MOTEUR  
412-355 UNIVERSAL TALADRO

NEW drill system with  
small handpiece for all  
drill attachments incl.  
Kirschner pin driver.

WITH RIGHT / LEFT ROTATION

LOCK POSITION

CONTINUOUSLY ADJUSTABLE ROTATION



## TECHNICAL DATA / DATES TECHNIQUES / DATOS TECNICOS

power supply / alimentation / alimentación:

PowerPack - Lithium Ion technology

speed range / vitesse de rotation / velocidad de rotación:

0 - 1000rpm (stepless)

cannulation / cannulation / canulación:

Ø 4.3mm

dimensions / dimensions / dimensiones:

137 x 93 x 197mm

weight / poids / peso:

1660g

standard / standard / estándar:

B, EN60601-1

### 412-361

wire / pin driver for drill (412-355) / Ø 1.0 to 4.0mm

guide fil métallique / broche pour moteur (412-355) / Ø 1,0 à 4,0mm

guía alambre / clavo para taladro (412-355) / Ø 1,0 hasta 4,0mm

### 412-363

safety pin for 412-360 + 412-361

douille de sécurité pour 412-360 + 412-361

aplique de seguridad para 412-360 + 412-36



**412-356 DRILL & REAMER**  
**412-356 MOTEUR POUR PERCAGE ET ALESAGE**  
**412-356 TALADRO PARA TALADRAR Y FRESAR**

NEW universal Drill &  
Reamer system for all  
orthopaedic indications  
and large bone surgery. .



WITH RIGHT / LEFT (forward / backward rotation)

LOCK POSITION

OSCILLATING MODE ON/OFF

CONTINUOUSLY ADJUSTABLE ROTATION

DRILL WITH 2 SPEED RANGES

TECHNICAL DATA / DATES TECHNIQUES / DATOS TECNICOS

power supply / alimentation / alimentación:

speed range / vitesse de rotation / velocidad de rotación:

cannulation / cannulation / canulación:

dimensions / dimensions / dimensiones:

weight / poids / peso:

standard / standard / estándar:

PowerPack - Lithium Ion technology

0 - 1000rpm / drill (stepless)

0 - 250rpm / reamer (stepless)

Ø 4.3mm

162 x 93 x 198mm

1850g

B, EN60601-1

**412-360**

wire / pin driver for drill / reamer (412-356) / Ø 1.0 to 4.0mm

guide fil métallique / broche pour moteur alésage (412-356) / Ø 1,0 à 4,0mm

guía alambre / clavo para taladro fresadora (412-356) / Ø 1,0 hasta 4,0mm

**412-363**

safety pin for 412-360 + 412-361

douille de sécurité pour 412-360 + 412-361

aplique de seguridad para 412-360 + 412-361



ATTACHMENTS - DRILL / REAMER  
ACCESSOIRES - PERCAGE / ALESAGE  
APLIQUES - TALADRO / FRESADORA



#### 412-372

Röhms - 3 jaw drill chuck, up to 7.0mm, with key  
Röhms - mandrin de serrage à 3 mors, jusqu'à 7,0mm, avec clé  
Röhms - portabroca con 3 garras, hasta 7,0mm, con llave



#### 412-373

Jacobs chuck, small with key (max. Ø 4.0mm)  
Jacobs mandrin, petit, avec clé (Ø max. 4,0mm)  
Jacobs portabroca, pequeña, con llave (Ø max. 4,0mm)



#### 412-374

Jacobs chuck, large with key (max. Ø 6.5mm)  
Jacobs mandrin, grand, avec clé (Ø max. 6,5mm)  
Jacobs portabroca, grande, con llave (Ø max. 6,5mm)



#### 412-375

quick action chuck with lock (max. Ø 6.5mm)  
mandrin à serrage rapide avec blocage (max. Ø 6,5mm)  
portabroca a sujeción rápida con bloqueo (max. Ø 6,5mm)



#### 412-376

quick action chuck without lock (max. Ø 6.5mm)  
mandrin à serrage rapide sans blocage (Ø max. 6,5mm)  
portabroca a sujeción rápida sin bloqueo (Ø max. 6,5mm)

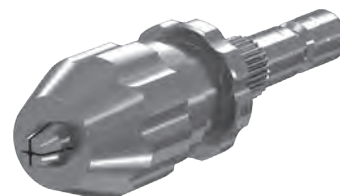

#### 412-377

Albrecht quick action chuck, small (max. Ø 3.5mm)  
Albrecht mandrin à serrage rapide, petit (Ø max. 3,5mm)  
Albrecht portabroca a sujeción rápida, pequeña (Ø max. 3,5mm)

ATTACHMENTS - DRILL / REAMER  
ACCESSOIRES - PERCAGE / ALESAGE  
APLIQUES - TALADRO / FRESADORA



**412-369**

adapter for AO attachments, small  
adaptateur pour inserts AO, petit  
adaptador para conexion AO, pequeño



**412-365**

adapter for AO attachments, big  
adaptateur pour inserts AO, grand  
adaptador para conexion AO, grande



**412-368**

adapter for Harris chuck  
adaptateur pour mandrin Harris  
adaptador para portabroca Harris



**412-367**

adapter for Hudson chuck  
adaptateur pour mandrin Hudson  
adaptador para portabroca Hudson



**412-371**

adapter 1/4"  
adaptateur 1/4"  
adaptador 1/4"



**412-366**

adapter for hexagonal attachment SW6  
adaptateur pour insert hexagonal SW6  
adaptador para conexion hexagonal SW6



**412-370**

adapter DIN  
adaptateur DIN  
adaptador DIN



**412-364**

adapter for radiolucent drill guide  
adaptateur pour guide fil métallique radiotransparent  
adaptador para guía alambre radiopermeable

412-357 SAGITTAL OSCILLATING SAW  
412-357 SCIE OSCILLANTE SAGITTALE  
412-357 SIERRA OSCILANTE SAGITAL



WITH ROTATABLE SAW BLADE CLAMPING IN 45° STEPS  
(8 POSITIONS)

MANUAL SPEED ADJUSTMENT AND OSCILLATING MODE

SHIFT LEVER FOR OPERATING IN TWO DIFFERENT SPEEDS

4° LATERAL SAW BLADE MOVEMENT

FOR SYNTHES / AO SAW BLADES

## TECHNICAL DATA / DATES TECHNIQUES / DATOS TECNICOS

power supply / alimentation / alimentación:

speed range / vitesse de rotation / velocidad de rotación:

dimensions / dimensions / dimensiones:

weight / poids / peso:

standard / standard / estándar:

PowerPack - Lithium Ion technology

0 - 9000rpm in pos. 1 (stepless)

0 - 11000rpm in pos. 2 (stepless)

166 x 111 x 211mm

1760g

B, EN60601-1

## SYNTHES / AO connection/raccordement/conexión \*

### 412-341

sternum saw blade for revision sternotomy





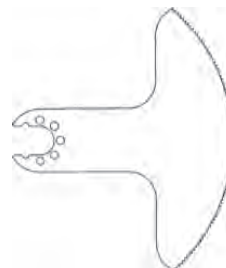

lame de scie sternum pour sternotomie de reprise

hoja de sierra esternón para esternotomía de revisión

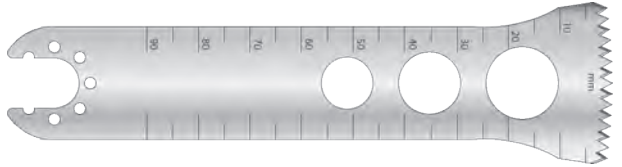
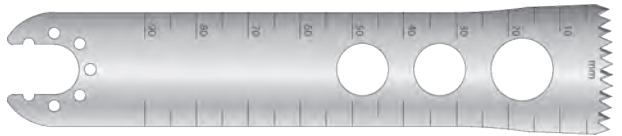

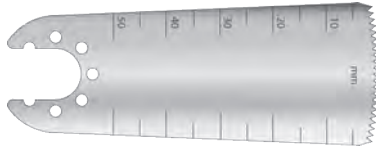

SYNTHESES / AO connection/raccordement/conexión \*

	cutting thickness épaisseur de coupe epesor del corte	depth profondeur profundidad	width largeur anchura	
412-321-09	0.89mm	90mm	31mm	
412-321-12	1.27mm			
412-320-09	0.89mm	90mm	25mm	
412-320-10	1.00mm			
412-320-11	1.19mm			
412-320-12	1.27mm			
412-320-13	1.37mm			
412-320-14	1.47mm			
412-322-09	0.89mm	90mm	19mm	
412-322-10	1.00mm			
412-322-12	1.27mm			
412-322-13	1.37mm			
412-323-09	1.00mm	90mm	13mm	
412-323-12	1.27mm			
412-328	0.4 / 0.6mm	48mm	27mm	
412-329	0.6 / 0.8mm	68mm	27mm	
412-327	0.4 / 0.6mm	48mm	14mm	
412-326-10	0.4 / 0.6mm	25mm	10mm	
412-325	0.4 / 0.6mm	27mm	6mm	

\* blades have to be ordered separately / minimum order quantity 5pcs / item no.

\* lames à commander séparément / quantité minimum à commander 5 pièces / no. d'article

\* hojas a pedir separadamente / cantidad minima a pedir 5 piezas / no. artículo

412-358 STERNUM / RECIPROCATING SAW  
412-358 SCIE STERNUM / SCIE A GUICHET  
412-358 SIERRA ESTERNON / SIERRA DE VAIVEN

Sternum saw with protection sleeve and keyless chuck with continuously adjustable rotation speed and switch lever from Step I to II. Basic model can be used as reciprocating saw.

EASY ASSEMBLING OF SAW BLADES - NO TOOLS REQUIRED

FOR SAW BLADES WITH STRYKER CONNECTION

ATTACHEMENT OF PROTECTION SLEEVE IN 4 DIFFERENT POSITIONS (locking at 90°)

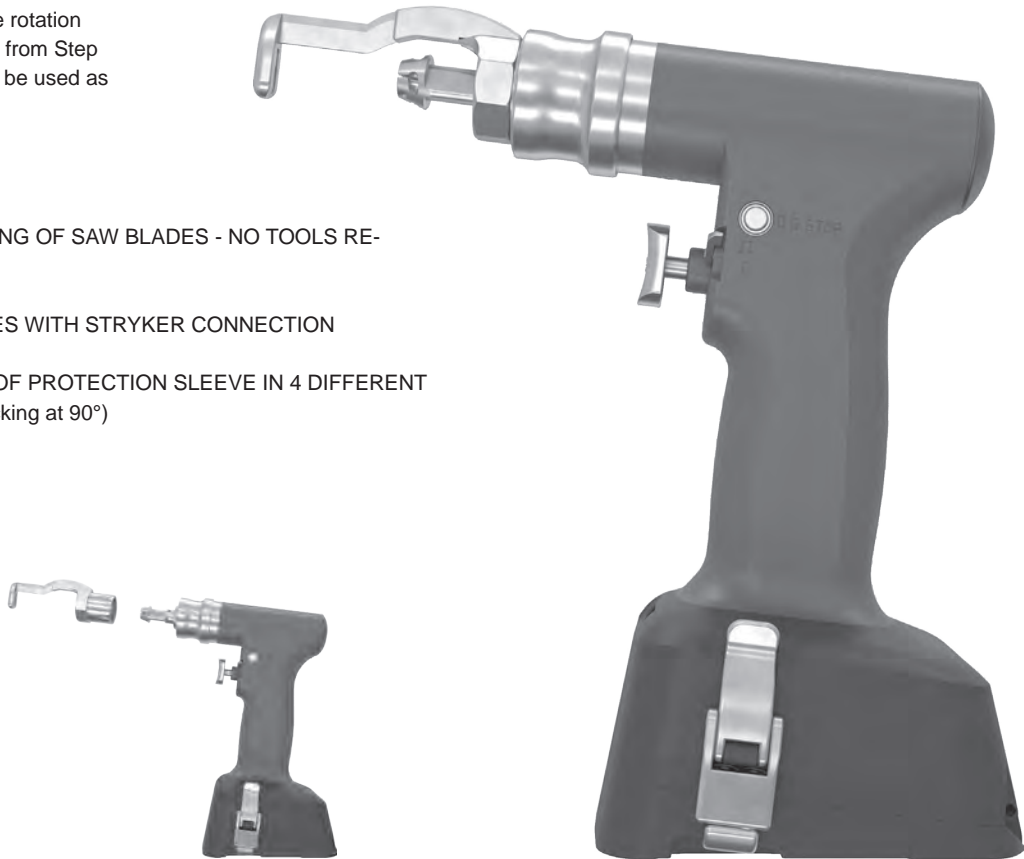

## TECHNICAL DATA / DATES TECHNIQUES / DATOS TECNICOS

power supply / alimentation / alimentación:

speed range / vitesse de rotation / velocidad de rotación:

dimensions / dimensions / dimensiones:

weight / poids / peso:

standard / standard / estándar:

PowerPack - Lithium Ion technology

0 - 7500rpm in pos. 1 (stepless)

0 - 10000rpm in pos. 2 (stepless)

188 x 111 x 206mm

1750g

B, EN60601-1



### 412-353-S

blade for reciprocating saw  
lame pour scie à guichet  
hoja para sierra de vaivén



### 412-354-S

blade for sternum saw  
lame pour scie sternum  
hoja para sierra esternón

**412-380 PowerPack**  
**412-380 PowerPack**  
**412-380 PowerPack**

The „ALL IN ONE“ PowerPack can be used together with all handpieces and comprises motor, electronic, software and accumulator in one ergonomic device.

Le PowerPack „ALL IN ONE“ peut être utilisé avec tous les pièces à main et contient moteur, électronique, software et accumulateur dans un dispositif ergonomique.

El PowerPack „ALL IN ONE“ puede ser utilizado con todas piezas de mano y contiene motor, electrónica, software y acumulador en dispositivo ergonómico.

High-capacity and long lasting accumulator with over-heat protection and without memory effect

Accumulateur de haute capacité et longue durée avec protection de surchauffe et sans effet de mémoire

Acumulador a gran capacidad y larga duración con protección de sobrecalentamiento y sin efecto memoria

Software and electronics for automatic recognition of the handpiece and settings

Software et électronique pour identification automatique de la pièce à main et paramètres

Software y electrónica para identificación automática de la pieza a mano y regulación

Complete PowerPack to be entered into the machine through a sterile funnel

Le PowerPack complet doit être inséré à travers une douille stérile dans la pièce à main.

El PowerPack completo debe ser insertado a través un aplicador estéril en la pieza a mano.



LED display shows the status of loading and illuminates the operating field during surgery

Un affichage LED montre l'état de charge et illumine la site opératoire pendant l'intervention.

Un indicador LED muestra el estado de carga y ilumina la área de operación durante la intervención.

TECHNICAL DATA / DATES TECHNIQUES / DATOS TECNICOS

type / type / tipo:	Li-ion
max. voltage / tension maximale / tensión máxima:	16.8V
operating voltage / tension de service / tensión de servicio	14.4V
capacity / capacité / capacidad	2.1AH
standard charging time / temps de charge standard / tiempo de carga estándar	< 90min
dimensions / dimensions / dimensiones:	89 x 87 x 102mm
weight / poids / peso:	760g

## CHARGER / CHARGEUR / CARGADOR



**412-381**  
charger for one battery, 220V  
chargeur pour une batterie, 220V  
cargador para una pila, 220V



**412-382**  
charger for two batteries, 220V  
chargeur pour deux batteries, 220V  
cargador para dos pilas, 220V



**412-383**  
charger for four batteries, 220V  
chargeur pour quatre batteries, 220V  
cargador para cuatro pilas, 220V

## SERVICE



**412-385**  
lubrication service frame  
support pour la lubrification  
soporte para la lubricación



**412-384**  
sterilising funnel for battery  
douille pour insertion stérile de la batterie  
aplique para inserción estéril de la pila

## RINSE ADAPTER



**412-390-2**  
rinse adapter for drills 412-355 / 356  
adaptateur rinçage pour broches 412-355 / 356  
adaptador para enjuague para brocas 412-355 / 356

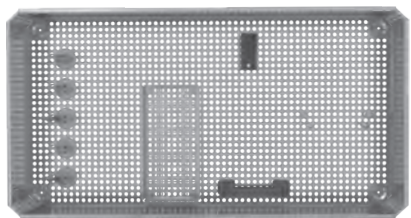

**561-0700-2**

tray with lid for 1 handpiece  
panier avec couvercle pour 1 pieces a main  
bandeja con tapa para 1 pieza de mano

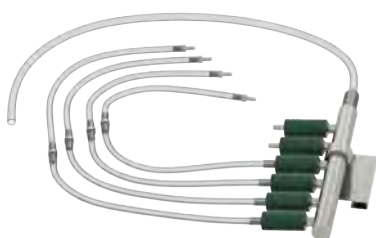

**412-391**  
rinsing set  
set rinçage  
set enjuaje

**561-0700-3**

tray with lid for 2 handpieces  
panier avec couvercle pour 2 pieces a main  
bandeja con tapa para 1 piezas de mano

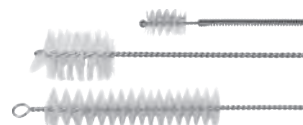

**412-392**  
cleaning brush set  
set brosses de nettoyage  
set cepillos de lavaje

## 1/1 SIZE CONTAINER

**Boden / Bottom / Fond / Fondo**



Boden ohne Filter  
Bottom without filter  
Fond sans filtre  
Fondo sin filtro

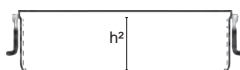

h 235 mm | h² 229 mm **562-5626-B**



**562-5752**  
paper, single use



**562-5753**  
PTFE, 2000 cycles

**Deckel / Lid / Couvercle / Tapa**



- 562-5601-LFS**
- 562-5601-LFY**
- 562-5601-LFG**
- 562-5601-LFB**
- 562-5601-LFR**
- 562-5601-LFD**
- 562-5601-LFP**
- 562-5601-LFM**

# **ELCON**

*MEDICAL INSTRUMENTS GmbH*

D - 78532 Tuttlingen  
Tel: +49 7461 9281-0  
info@elcon-medical.de

Dr. Karl-Storz-Str. 26  
Fax: +49 7461 9281-29  
www.elcon-medical.com