



HNO CHIRURGIE
ENT SURGERY
OTO-RINO-LARINGOLOGIA
OTO-RHINO-LARYNGOLOGIE

ELCON
MEDICAL INSTRUMENTS GmbH

430 - 480
HNO CHIRURGIE
ENT SURGERY
OTO-RINO-LARINGOLOGIA
OTO-RHINO-LARYNGOLOGIE



Grau dargestellte Artikelnummern bezeichnen „distributed by ELCON“ Produkte
Article numbers shown in grey indicate „distributed by ELCON“ products
Los numeros de articulos mostrados en gris indican productos „distribuidos por ELCON“
Les numéros d’articles affichés en gris indiquent les produits « distribués par ELCON »

ELCON

A

Abraham, tonsil knife	95
Adenoid curette	101
Adenoid forceps	102
Adneotome	100
Agnew, tympanum perforator	17
Alar hooks	63
Alar retractor	64
Aluminium, tuning fork	8
Antrum cannula	71
Antrum curette	73, 74
Antrum grasping forceps	83
Antrum hook	33
Antrum punch	76, 78, 79
Antrum trocar needle	70
Asch, septum straightening forceps	55
Aufricht, glabella rasp	67
Aufricht, glabella rasp tungsten	66
Aufricht, nasal bridge retractor	65
Aufricht, nasal rasp diamond	68

B

Ballenger, septum swivel knife	56
Ballenger, tonsil forceps	93
Ballenger-Hajek, elevator	58
Baracani, laryngeal forceps tip	109
Barbara, needle	29
Barnes, suction tube	25
Barnhill, andenoid curette	101
Baron, suction tube	25
Becker, septum scissors	54
Beckmann, andenoid curette	101
Beckmann, nasal speculum	41
Belluci, micro ear scissors	36
Beyer, antrum punch	76
Billeau, ear loop	15
Binner, polyp grasping forceps	84
Biopsy forceps	82, 83
Bipod suspension	92
Blakesley, nasal forceps	50, 51, 80
Blohmke, tonsil forceps	93
Bone cutting forceps	54
Bone punch	77
Bose, tracheal hook	130
Bougie, frontal sinus	71
Bronchoscope	6
Bronchoscopy forceps	126, 127, 128
Bruenings, laryngeal forceps tip	109
Bruenings, septum forceps	53
Bruenings, tongue depressor	86
Bruenings, tonsil knife	95
Bruenings, tonsil snare	97
Buchwald, tongue depressor	86
Buck, ear curette	15

C

Caliper	34
Cannula, antrum	71
Cannula, laryngeal	103
Cannula, tonsil	103
Caplan, nasal scissors	54
Carilage slitting knife	62
Caroll, osteotome	59
Chest support	92
Chisel	59, 60, 61
Chisel, Septum	59
Cinelli, osteotome	60
Circular cutting forceps	84
Coakley, antrum curette	74
Colver, tonsil forceps	93

Colver, tonsil knife	95
Concotome	48, 79
Converse, alar hook	41
Converse, rhinoplastic knife	62
Cordes, laryngeal forceps tip	110
Cottle, alar retractor	64
Cottle, bone and cartilage crusher	69
Cottle, chisel	60, 61
Cottle, elevator	58
Cottle, finger ring hook	63
Cottle, hook	64
Cottle, mallet	61
Cottle, nasal hook	63
Cottle, nasal rasp diamond	68
Cottle, nasal rasp	67
Cottle, nasal retractor	64
Cottle, nasal scissors	47
Cottle, nasal speculum	43
Cottle, osteotome	60
Cottle, raspatory	58
Cottle, septum knife	56
Cottle-Neivert knife guide	64
Cottle-Neivert, retractor	64
Cottle-Walsham, septum straightening forceps	55
Craig, septum forceps	53
Crusher, bone and cartilage	69
Curette	27, 32, 73
Curette, andenoid	101
Curette, antrum	73, 74
Curette, frontal sinus	73
Curettes, ear	15

D

Daubenspeck	74
Davis-Boyle, mouth gag	88
Davis-Boyle, tongue depressor	90
Davis-Meyer, mouth gag	88
Davis-Meyer, tongue depressor	90
Diagnostic set fiber optic	11
Diagnostic set	11
Diamond nasal rasp	68
Dieter, malleus nipper	38
Dilator, tracheal	129
Dingmann, mouth gag	89
Dingmann, tongue depressor	91
Director, goitre	129
Dissector	33
Dissector, tonsil	96
Drafin, bipod suspension	92

E

Ear cures	15
Ear dressing forceps	19
Ear forceps	20, 21, 22, 35
Ear hook, micro	29, 30
Ear hooks	16
Ear knife	17, 31
Ear knife, micro	31
Ear loop	15
Ear needle, micro	29, 30
Ear snare wires	18
Ear snare	18
Ear spatula	16
Ear speculum	11, 12, 13
Ear syringe	9
Ear, micro cup forceps	37
Ear, micro forceps	35, 37, 38
Ear, micro scissors	36
Eicken, antrum cannula	71
Eicken, antrum trocar needle	70
Elcon, nasal scissors	47

Elevator	57, 58
Elevator, suction	57
Epiglottis holder	106
Esophagoscopy forceps	127, 128
Eve, tonsil snare	97
Extension tube	108

F

Farrior, ear speculum	13
Faulkner, antrum curette	74
Fenestra hook	33
Fisch, caliper	34
Fisch, dissector	33
Fisch, micro ear forceps	35
Fisch, micro ear scissors	36
Fisch, perforator	33
Fisch, sickle knife	31
Fisch, suction tube	25
Fisch-Belluci, micro ear scissors	36
Fisch-McGee, wire crimper forceps	38
Fisher, tonsil knife	95
Flap knife	31
Fomon, allar hook	63
Fomon, nasal rasp diamond	68
Fomon, nasal rasp tungsten	66
Fomon, nasal rasp	67
Fomon, nasal scissors	47
Fomon-Masing, nasal rasp	67
Footplate hook	33
Forceps, septum morcelizer	55
Forceps, adenoid	102
Forceps, antrum grasping	83
Forceps, biopsy	82, 83
Forceps, bone cutting	54
Forceps, bronchoscopy	126, 127, 128
Forceps, ear dressing	19
Forceps, ear	20, 21, 22, 35, 37, 38
Forceps, esophagoscopy	127, 128
Forceps, giraffe	81
Forceps, goitre grasping	130
Forceps, piston introducing	38
Forceps, laryngeal	108
Forceps, micro laryngeal	115, 116, 117, 118, 119, 120
Forceps, miniature laryngeal	111, 112, 113, 114
Forceps, nasal cutting	48
Forceps, nasal dressing	44
Forceps, nasal	45, 48, 49, 50, 51, 80
Forceps, polyp grasping forceps	84
Forceps, septum straightening forceps	55
Forceps, septum	53, 54
Forceps, tonsil abscess	94
Forceps, tonsil	93, 94
Forceps, turbinate crushing	55
Forceps, wire crimper	38
Formby, ear hook and spoon	16
Fraenkel, laryngeal forceps tip	109
Frazier-Ferguson, suction tube	23
Freer, elevator	57
Freer-Yasargi, elevator	57
Freer, hook	63
Freer, mucosal knife	56
Freer, septum chisel	59
Freer, septum knife	56
Frontal sinus bougie	71
Frontal sinus curette	73
Frontal sinus punch	85
Frontal sinus seeker	72
Fuller, piston introducing forceps	38

G

Giraffe forceps	81
-----------------	----

Glabella rasp tungsten	66
Glabella rasp	67
Goitre director	129
Goitre grasping forceps	130
Goitre scissors	129
Gorny, suction elevator	57
Gouge	59
Gouge, septum	59
Graft holder	32
Greven, wire crimper forceps	38
Gross, ear hook/curette	16
Gruber, ear speculum	12
Gruenwald, ear forceps	20
Gruenwald, nasal forceps	45
Gruenwald-Henke, nasal cutting forceps	48

H

Hajek, mallet	61
Hajek-Kofler, sphenoid punch	75, 76
Hall, antrum curette	73
Halle, elevator	58
Handle, laryngeal mirror	104
Hartman, nasal cutting forceps	48
Hartmann, ear dressing forceps	19
Hartmann, ear forceps	21, 22
Hartmann, ear speculum	11
Hartmann, nasal dressing forceps	44
Hartmann, nasal speculum	41
Hartmann, tongue depressor	86
Hartmann, tuning fork	8
Hartmann-Halle, nasal speculum	42
Hartmann-Noyes, ear forceps	21
Hartmann-Wullstein, ear forceps	21, 22
Hause, caliper	34
Henke, tonsil dissector	96
Heymann, nasal scissors	47
Hoffmann, ear forceps	22
Holmgren, ear speculum	10
Hook, antrum	33
Hook, fenestra	33
Hook, footplate	33
Hook, laryngeal	122, 123
Hook, tracheal	130
Hooks	63, 64, 65
Hooks, alar	63
Hooks, ear	16
Hooks, nasal	63, 64, 65
House measuring rod	34
House suction/irrigation tube	25
House, curette	27
House, suction canula	24
House, suction handle	24
Huber, universal handle	108
Hurd, tonsil dissector	96
Hurd, tonsil needle	95

I

Incision knife	31
Injection needle, laryngeal	124
Introducer, prothesis	34

J

Jansen, ear forceps	20
Jansen, nasal forceps	45
Jansen, septum forceps	54
Jansen-Middleton, septum forceps	54
Jennings, mouth gag	87
Joseph, hook	63
Joseph, nasal saw	69

Joseph, rhinoplastic knife	62	Malleus nipper	38
Jospeh, nasal rasp	67	Maltz, nasal rasp tungsten	66
Jurasz, adenoid forceps	102	Maltz, nasal rasp	67
		Masing cartilage slitting knife	62
K		Masing, elevator	58
Kazanjan, bone cutting forceps	54	Masing, osteotome	60
Kerrison, bone puch	77	Maxillary ostium seeker	72
Killian, elevator	57	Mc Gee, wire crimper forceps	38
Killian, nasal speculum	42	Mc Ivor, mouth gag	88
Killian-Claus, septum gouge	59	Mc Ivor, tongue depressor	90
Killian-Struycken, nasal speculum	43	Mc Kenty, sphenoid punch	75
Kilner, alar hook	63	McKenty, elevator	57
Kilner, retractor	65	McKenty, rasptory	58
Kilner-Doughty, mouth gag	89	Measuring rod	34
Kleinert-Kutz, nasal rasp	67	Michel, rhinoscopic mirror	104
Kleinsasser, knot tier	123	Micro dissector	33
Kleinsasser, laryngeal hook	122, 123	Micro ear cup forceps	37
Kleinsasser, laryngeal knife	122	Micro ear forceps	35
Kleinsasser, micro laryngeal instruments	122, 123	Micro ear hook	29, 30, 33
Kleinsasser, needle guide	123	Micro ear knife	31
Kleinsasser, suction elevator	123	Micro ear needle	29, 30
Kleinsasser, universal handle	123	Micro ear scissors	36
Knife guide	64	Micro laryngeal forceps	115, 116, 117, 118, 119, 120
Knife, cartilage slitting	62	Micro laryngeal hook	122, 123
Knife, ear	17, 31, 32	Micro laryngeal knife	122
Knife, flap	31	Micro laryngeal knot tier	123
Knife, incision	31	Micro laryngeal needle guide	123
Knife, lancet	31	Micro laryngeal scissors	118
Knife, laryngeal	122	Micro laryngeal suction elevator	123
Knife, mucosal	56	Micro laryngeal universal handle	123
Knife, rhinoplastic	62	Micro laryngoscope	4
Knife, round	31, 122	Micro raspatory	32
Knife, septum	56	Miller, nasal rasp tungsten	66
Knife, sickle	17, 31, 74, 122	Miniature laryngeal forceps	111, 112, 113, 114
Knife, swivel	56	Miniature laryngeal scissors	112
Knife, tonsil	95	Mirror, laryngeal	104, 105
Knot tier, laryngeal	123	Mirror, rhinoscopic	104
Kocher, goitre director	129	Molt, mouth gag	87
Koenig, syringe	103	Moritz-Schmidt, tongue depressor	86
Krause, ear snare	18	Mouth gag	87, 88, 89
Krause, laryngeal forceps tip	110	Mucosal knife	56
Krause, nasal snare	46		
Kressner, turbinate crushing forceps	55		
		N	
L		Nager, pillar retractor	96
La Force, adenotome	100	Nager, tonsil needle	95
Laborde, tracheal dilator	129	Nasal bridge retractor	65
Lahey, goitre grasping forceps	130	Nasal cutting forceps	48
Lancet knife	31	Nasal dressing forceps	44
Lange, laryngeal forceps tip	109	Nasal forceps	45, 48, 49, 50 51, 80
Laryngeal forceps	108	Nasal hook	63, 64, 65
Laryngeal injection needle	124	Nasal rasp	66, 67, 68
Laryngeal mirror	104, 105	Nasal rasp, diamond	68
Laryngoscope	4,5	Nasal rasp, tungsten	66
Lempert, curette	27	Nasal saw	69
Lempert, raspatory	28	Nasal scissors	47
Lempert, raspatory	58	Nasal seculum	41, 42, 43
Light source	8	Nasal snare	46
Lichtwitz, antrum cannula	71	Nasal, retractor	63, 64, 65
Loop, ear	15	Naso-Pharyngoscope	7
Luc, septum forceps	53	Neddle guide, laryngeal	123
Lucae, ear forceps	20	Needle antrum	70
Lucae, ear hook	16	Needle, septum	70
Lucae, tuning fork	8	Needle, tonsil	95
Lucae, tympanum perforator	17	Negus, chest support	92
Luer, suction tube	23, 24	Negus, tonsil forceps	94
		Neivert knife guide	64
		Neivert, alar retractor	64
		O	
M		Oespphagoscope	6
Mallet	61	Osteotome	59, 60, 61
		Otoscope	1

Otoscope, semiflex 3

P

Pennington, elevator 58
Perforator 33
Pillar retractor 96
piston introducing forceps 38
Plester, antrum hook 33
Plester, flap knife 31
Plester, footplate hook 33
Plester, hook 33
Plester, incision knife 31
Plester, prosthesis introducer 34
Plester, scraper 33
Plester, sickle knife 31
Plester, suction tube 23
Politzer, ear speculum 12
Politzer, tympanum perforator 17
Polyp grasping forceps 85
Prosthesis introducer 34
Punch, antrum 76, 78, 79
Punch, bone 77
Punch, circular cutting 84
Punch, frontal sinus 85
Punch, sphenoid 75, 76

R

Ragnell, retractor 65
Rasp 66, 67, 68
Rasp, glabella tungsten 66
Rasp, glabella 67
Rasp, nasal diamond 68
Rasp, nasal tungsten 66
Rasp, nasal 66, 67, 68
Raspatory 28, 32, 58
Reichert, epiglottis holder 106
Retractor 63, 64, 65
Retractor, alar 64
Retractor, nasal bridge 65
Retractor, nasal 63, 64, 65
Retractor, pillar 96
Retractor, thyroid 130
Rhinoplastic knife 62
Rhinoscopic mirror 104
Ring, tongue depressor 91
Ritter, frontal sinus bougie 71
Rod, measuring 34
Rosen, curette 32
Rosen, fenestra hook 33
Rosen, lancet knife 31
Rosen, needle 29
Rosen, raspatory 32
Rosen, round knife 31
Rosen, round knife 31
Round knife 29
Rubin, osteotome 59
Rubin, osteotome 60
Rubin, septum morcelizer 55
Russel-Davis, tongue depressor 91

S

Saw, nasal 69
Scheinmann, laryngeal forceps tip 109, 110
Schnidt, tonsil forceps 94
Schoemaker, goitre scissors 129
Schoenborn, thyroid retractor 130
Schuhknecht, hook 30
Schuhknecht, needle 30
Schuhknecht, suction tube 26

Schuhknecht, wire bending die 40
Schuhmacher, laryngeal forceps tip 110
Scissors, goitre 129
Scissors, micro ear 36
Scissors, micro laryngeal 118
Scissors, miniature laryngeal 112
Scissors, nasal 47, 54
Scraper 33
Seeker, ball end 16
Seeker, frontal sinus 72
Seeker, maxillary ostium 72
Seiffert, laryngeal forceps tip 109
Senn-Miller, retractor 65
Septum forceps 53, 54
Septum knife 56
Septum morcelizer 55
Septum needle 70
Septum scissors 54
Septum straightening forceps 55
Sexton-Gerzog, tympanum perforator 17
Shambaugh, hook 29
Shambough-Derlacki, rasptory 28
Shapleigh, ear curette 15
Shea-Belluci, micro ear scissors 36
Sheehan, osteotome 59
Sickel knife 17, 31, 74
Silver, osteotome 60
Sinuscope 1, 2
Sinuscope, semiflex 3
Sludder-Ballenger, tonsillotome 99
Snare wires 18, 46, 98
Snare, ear 18
Snare, nasal 46
Snare, tonsil 97
Snellen, ear loop 15
Spatula, ear 16
Speculum, ear 10, 11, 12, 13
Speculum, nasal 41, 42, 43
Speculum, tracheal 129
Sphenoid punch 75, 76
St. Clair-Thomson, adnoid curette 101
Stammberger, antrum punch 78, 79
Stammberger, biopsy forceps 83
Stapes caliper 34
Struempel, ear forceps 22
Struempel-Voss, nasal forceps 49
Struyken, conchotome 79
Struyken, nasal cutting forceps 48
Suction canula 24
Suction elevator 57, 123
Suction elevator, laryngeal 123
Suction handle 24
Suction tube 23, 24, 25, 26
Swivel knife 56
Syringe 9, 103
Syringe, ear 9

T

Takahashi, nasal forceps 49, 51
Telelaryngoscope 5
Thilenius, tonsil abscess forceps 94
Thyroid retractor 130
Tieck-Halle, nasal speculum 41
Tilley, ear dressing forceps 19
Tilley, nasal dressing forceps 44
Tobey, antrum puch 79
Tobold, tongue depressor 86
Tongue depressor 86, 90, 91
Tonsil abscess forceps 94
Tonsil cannula 103
Tonsil forceps 93, 94
Tonsil knife 95
Tonsil needle 95

Tonsil snare	97
Tonsil, dissector	96
Tonsillotome	99
Tracheal dilator	129
Tracheal hook	130
Tracheal speculum	129
Trocar, antrum needle	70
Troeltsch, ear forceps	20
Troeltsch, nasal forceps	45
Trouseau, tracheal dilator	129
Tungsten nasal rasp	66
Tuning fork	8
Turbinate crushing forceps	55
Tyding, tonsil forceps	93
Tyding, tonsil snare	97
Tympanum perforator	17

V

Verhoeven, suction tube	25
Vickers, mallet	61
Vienna, nasal speculum	41

W

Wagner, ear hook	16
Walsham, septum straightening forceps	55
Walter, gouge	59
Walter, nasal bridge retractor	65
Walter, Osteotome	59
Watson-Williams, nasal forceps	49
Weerda, tracheal speculum	129
Weingaertner, ear forceps	22
White, tonsil forceps	93
Wieder, tongue depressor	86
Wien, nasal speculum	41
Wire bending die	40
Wire crimper forceps	38
Wuerzburg, tongue depressor	90
Wullstein, needle	29
Wullstein, raspatory	28
Wullstein, sickle knife	31
Wullstein, suction handle	24
Wullstein, suction tube	25

Z

Zaufal, ear spatula	16
Zoellner, ear speculum	12
Zoellner, suction tip	26
Zoellner, suction tube	26

120		198-816	103	230-86-030	6	430-120-05	8	430-297	13
125-101	47					430-132	8	430-298	13
125-105	47	200		300		430-133	8	430-299	13
125-105Z	47	203-101	129	301-455	130	430-134	8	430-340	11
125-561	129	230-34-000	1	301-456	130	430-135	8	430-341	11
125-800	47					430-136	8	430-342	11
125-813	47	230		340		430-137	8	430-343	11
		230-34-000SF	3	341-929	23	430-144	8	430-344	11
140		230-34-030	1	341-930	23	430-170-00	12	430-345-00	11
141-300	20	230-34-030SF	3	341-931	23	430-171	12	430-346-00	11
141-301	20	230-34-045	1	341-932	23	430-172	12	430-347-00	11
141-311	45	230-34-070	1	341-933	23	430-173	12	430-348	11
141-312	45	230-34-100	1	341-934	23	430-180-00	11	430-349	11
141-330	20	230-34-130	1	341-935	23	430-181	11	430-391	10
141-340	20	230-35-000	2	341-936	23	430-182	11	430-392	10
141-340	45	230-35-030	2	344-011	77	430-183	11	430-393	10
141-344	20	230-35-070	2	344-012	77	430-200	11	430-500	15
141-344	45	230-36-000SF	3	344-013	77	430-201	11	430-501	15
		230-36-030SF	3	344-014	77	430-202	11	430-502	15
		230-36-045	2	344-015	77	430-203	11	430-503	15
150		230-36-045SF	3	344-041	77	430-204	11	430-504	15
151-621	94	230-36-070SF	3	344-042	77	430-205-00	11	430-507	15
151-623	94	230-436-000	2	344-043	77	430-206-00	11	430-510	15
		230-436-030	2	344-044	77	430-208-00	11	430-511	15
160		230-436-070	2	344-045	77	430-244-00	12	430-512	15
160-300	65	230-58-000	2	344-051	77	430-245-00	12	430-513	15
160-301	65	230-58-000SF	3	344-052	77	430-246	12	430-514	15
160-381	130	230-58-030	2	344-053	77	430-247	12	430-517	15
160-382	130	230-58-030SF	3	344-054	77	430-248	12	430-520	15
160-383	130	230-58-045	2	344-055	77	430-249	12	430-521	15
160-384	130	230-58-070	2	344-071	77	430-260-00	12	430-522	15
160-391	130	230-59-000	2	344-072	77	430-2651	12	430-523	15
160-392	130	230-59-030	2	344-073	77	430-2652	12	430-524	15
160-393	130	230-59-045	2	344-074	77	430-2653	12	430-527	15
160-394	130	230-59-070	2	344-075	77	430-2654	12	430-530	15
160-439	130	230-62-070	5	344-141	77	430-2654	12	430-531	15
		230-62-090	5	344-142	77	430-2655	12	430-532	15
180		230-62-370	5	344-143	77	430-2656	12	430-532	15
180-900	23	230-62-390	5	344-144	77	430-2661	13	430-533	15
180-901	23	230-63-070	4	344-145	77	430-2662	13	430-534	15
180-902	23	230-63-090	4			430-2663	13	430-537	15
180-903	23	230-63-170	4	410		430-2664	13	430-540	15
181-122	23	230-63-190	4	410-610	61	430-2665	13	430-541	15
181-123	23	230-63-270	4	410-623	61	430-2666	13	430-542	15
181-124	23	230-63-370	5	410-624	61	430-2667	13	430-543	15
181-126	23	230-63-390	5	430-100-05	8	430-2668	13	430-544-01	15
		230-64-070	4			430-2669	13	430-544-02	15
190		230-70-280	7	430		430-281	13	430-544-03	15
190-460	70	230-70-340	7	430-101	8	430-282	13	430-545	15
190-461	70	230-81-000	1	430-102	8	430-283	13	430-546	15
190-462	70	230-81-030	1	430-103	8	430-284	13	430-547	15
190-470	70	230-82-000	1	430-104	8	430-285	13	430-559	16
190-471	70	230-82-000S	1	430-105	8	430-286	13	430-560-01	16
190-472	70	230-82-030	1	430-106	8	430-287	13	430-560-02	16
198-204	103	230-84-000	6	430-107	8	430-288	13	430-560-03	16
198-810	103	230-84-030	6	430-112	8	430-289	13	430-560-04	16
198-811	103	230-84-100	6	430-113	8	430-291	13	430-560-05	16
198-812	103	230-84-130	6	430-114	8	430-292	13	430-560-05	16
198-813	103	230-85-000	6	430-115	8	430-293	13	430-560-06	16
198-813	70	230-85-030	6	430-116	8	430-294	13	430-560-06	16
198-814	103	230-86-000	6	430-117	8	430-295	13	430-560-07	16
						430-296	13	430-576	16

NUMERISCHER INDEX
 NUMERIC INDEX
 ÍNDICE NUMÉRO
 INDEX NUMERIQUE



430-577	16	431-519-02	28	433-601	25	433-830-15	29	433-935R	33
430-578	16	431-533	28	433-602	25	433-830-20	29	433-937L	33
430-580	16	431-535	28	433-603	25	433-830-25	29	433-937R	33
430-581	16	432-022	35	433-604	25	433-833	33	433-940-03	33
430-584	16	432-030	35	433-605	25	433-840	30	433-940-04	33
430-594	16	432-052	35	433-612	25	433-841	30	433-940-05	33
430-610	17	432-053	35	433-613	25	433-850-03	30	433-940-06	33
430-611	17	432-055	35	433-614	25	433-850-06	30	433-960	33
430-613	17	432-057	35	433-620	25	433-850-10	30	433-962-02	33
430-625	17	432-060	35	433-622	25	433-855-03	30	433-962-04	33
430-630	17	432-062	35	433-624	25	433-855-06	30	433-962-06	33
430-631	17	432-063	35	433-639	25	433-855-10	30	433-970	33
430-643	17	432-065	35	433-640	25	433-860-03	30	433-971	33
430-700	18	432-067	35	433-641	25	433-860-06	30	433-978	34
430-730-20	18	432-152	38	433-642	25	433-860-10	30	433-994-04	34
430-730-25	18	432-300	36	433-643	25	433-865-03	30	433-994-06	34
430-730-30	18	432-303	36	433-644	25	433-865-06	30	433-995-04	34
430-732-20	18	432-305	36	433-645	25	433-865-10	30	433-995-06	34
430-732-25	18	432-320	36	433-666	26	433-870-02	30	433-995-08	34
430-732-30	18	432-340	36	433-667	26	433-870-03	30	433-996-35	34
430-900	9	432-341	36	433-668	26	433-870-06	30	433-996-40	34
430-901	9	432-343	36	433-679	26	433-870-10	30	433-996-45	34
430-902	9	432-345	36	433-681	26	433-875-02	30	433-996-50	34
430-903	9	432-360	36	433-681-05	26	433-875-03	30		
430-905	9	432-381	36	433-681-07	26	433-875-06	30	440	
430-906	9	432-383	36	433-681-09	26	433-875-10	30	440-200	41
430-908	9	432-530	37	433-681-12	26	433-899	31	440-201	41
431-010	21	432-531	37	433-730-15	26	433-900-10	31	440-202	41
431-011	21	432-533	37	433-730-20	26	433-900-15	31	440-210	41
431-013	21	432-535	37	433-731-15	26	433-900-18	31	440-210AS	41
431-015	21	432-580	37	433-731-20	26	433-900-20	31	440-211	41
431-016	21	432-581	37	433-732-15	26	433-900-23	31	440-211AS	41
431-020-10	22	432-583	37	433-732-20	26	433-900-25	31	440-212	41
431-020-15	22	432-585	37	433-800	29	433-901-10	31	440-212AS	41
431-020-20	22	432-720	38	433-801	29	433-901-14	31	440-220	42
431-020-25	22	432-722	38	433-810	29	433-901-16	31	440-220AS	42
431-020-30	22	432-723	38	433-811	29	433-901-20	31	440-221	42
431-030	22	432-725	38	433-812	29	433-901-23	31	440-221AS	42
431-031	22	432-760	38	433-813	29	433-901-26	31	440-222	42
431-033	22	432-770	38	433-814	29	433-901-28	31	440-222AS	42
431-040	22	432-776	38	433-815	29	433-901-30	31	440-230	41
431-050	22	432-780	40	433-820-03	29	433-903-15	31	440-230AS	41
431-063	19	433-405-06	24	433-820-06	29	433-903-20	31	440-231	41
431-070	19	433-405-08	24	433-820-10	29	433-903-25	31	440-231AS	41
431-072	19	433-405-10	24	433-825-02	29	433-903-30	31	440-234	41
431-080	21	433-405-12	24	433-825-03	29	433-906-30	31	440-250	42
431-480-01	27	433-405-15	24	433-825-04	29	433-906-35	31	440-250AS	42
431-481-01	27	433-405-18	24	433-825-06	29	433-907-10	31	440-251	42
431-481-02	27	433-405-20	24	433-825-08	29	433-908-01	31	440-251AS	42
431-481-03	27	433-405-25	24	433-825-10	29	433-908-03	31	440-252	42
431-481-04	27	433-405-30	24	433-825-12	29	433-908-04	31	440-252AS	42
431-482-01	27	433-451-10	24	433-825-15	29	433-908-05	31	440-253	42
431-499	27	433-451-15	24	433-825-20	29	433-910	32	440-253AS	42
431-500	27	433-451-20	24	433-825-25	29	433-913	32	440-254	42
431-501	27	433-453-30	24	433-830-02	29	433-914	32	440-254AS	42
431-502	27	433-453-40	24	433-830-03	29	433-915	32	440-264-40AS	43
431-503	27	433-453-50	24	433-830-04	29	433-916	32	440-264-55AS	43
431-504	27	433-500	24	433-830-06	29	433-917	32	440-264-75AS	43
431-505	27	433-504	24	433-830-08	29	433-918	33	440-264-90AS	43
431-515	28	433-521	25	433-830-10	29	433-920	32	440-270AS	43
431-519-01	28	433-522	25	433-830-12	29	433-935L	33	440-271AS	43

440-272AS	43	441-195-02	72	441-655-36	50	443-531-15	79	444-2263	85
440-273AS	43	441-195-03	72	441-655-40DT	51	443-710	78	444-2265	85
440-275AS	43	441-195-04	72	441-655-42	50	443-710L	78	444-2267	85
440-276AS	43	441-195-05	72	441-655-48	50	443-710R	78	444-2300-35	84
440-277AS	43	441-195-06	72	441-655-50DT	51	443-712	78	444-2300-45	84
440-278AS	43	441-200	73	441-660-01	49	443-712L	78	444-2301-35	84
440-400	56	441-202	73	441-660-01DT	51	443-712R	78	444-2301-45	84
440-404	74	441-203	73	441-660-02	49	443-719L	79		
440-406	74	441-207	73	441-660-02DT	51	443-719R	79	450	
440-410	56	441-208	73	441-660-03	49	443-720	78	450-202	62
440-450	56	441-209	73	441-660-03DT	51	443-722	78	450-203	62
440-451	56	441-213	73	441-661-01	49	443-725	79	450-206	62
440-452	56	441-214	73	441-661-01DT	51	443-739	79	450-207	62
440-455	56	441-215-01	73	441-661-02	49	443-739L	79	450-210	62
440-456	56	441-215-02	73	441-661-02DT	51	443-739R	79	450-211	62
440-457	56	441-216-01	73	441-661-03	49	443-750-25	80	450-224	56
440-500	59	441-216-02	73	441-661-03DT	51	443-750-30	80	450-241	62
440-501	59	441-220	74	441-668-01	49	443-750-35	80	450-250	64
440-530	59	441-241	74	441-668-02	49	443-750-40	80	450-251	64
440-532	59	441-242	74	441-668-03	49	443-750-50	80	450-270-02	61
440-534	59	441-243	74	441-675-25DT	51	443-751-25	80	450-270-04	61
440-536	59	441-244	74	441-675-30	50	443-751-30	80	450-270-07	61
440-591	59	441-245	74	441-675-30DT	51	443-751-35	80	450-270-09	61
440-593	59	441-246	74	441-675-35DT	51	443-751-40	80	450-270-12	61
440-600-04	57	441-270	73	441-675-36	50	443-753-35	80	450-291-02	59
440-600-05	57	441-271	73	441-675-40DT	51	443-753-40	80	450-291-03	59
440-603	57	441-272	73	441-675-42	50	443-760-26	80	450-291-04	59
440-604	57	441-280	74	441-675-48	50	443-760-36	80	450-291-07	59
440-612	58	441-281	74	441-675-50DT	51	443-760-42	80	450-291-09	59
440-615	57	441-282	74	441-689	49	443-761-26	80	450-291-12	59
440-616	57	441-283	74	441-690-25	50	443-761-36	80	450-292-03	59
440-620	57	441-425	54	441-690-25DT	51	443-761-42	80	450-292-04	59
440-620	58	441-502	44	441-690-35	50	444-0280-30	85	450-302	59
440-621	57	441-504	44	441-690-35DT	51	444-2200	83	450-303	59
440-622	57	441-505	44	441-690-40DT	51	444-2201	83	450-304	59
440-627	57	441-550	47	441-690-42	50	444-2210	83	450-305	59
440-630	57	441-551	47	441-691-25	50	444-2210-20	81	450-306	59
440-640	58	441-553	47	441-691-25DT	51	444-2210-30	81	450-307	59
440-645	58	441-592-01	48	441-691-35	50	444-2210-40	81	450-308	59
440-694	57	441-592-02	48	441-691-35DT	51	444-2211-20	81	450-309	59
440-700	46	441-592-03	48	441-691-40DT	51	444-2211-30	81	450-310	59
440-760-30	46	441-592-04	48	441-691-42	50	444-2211-40	81	450-311	59
440-760-40	46	441-600-01	48	441-696	49	444-2212-26	82	450-312	59
440-762-30	46	441-600-02	48	441-701	53	444-2212-40	82	450-320	60
440-762-35	46	441-624	48	441-702	53	444-2213-26	82	450-322	60
440-762-40	46	441-650-25	50	441-710	53	444-2213-40	82	450-323	60
440-943-25	71	441-650-25DT	51	441-711	53	444-2214-20	81	450-324	60
440-943-30	71	441-650-30	50	441-712	53	444-2214-40	81	450-325	60
440-943-40	71	441-650-30DT	51	441-745	53	444-2215-20	81	450-328	60
440-946-25	71	441-650-35DT	51	441-810	54	444-2215-40	81	450-330	60
440-946-25M	71	441-650-36	50	441-815	54	444-2216-26	82	450-332	60
440-946-30	71	441-650-40DT	51	441-836	75	444-2216-40	82	450-334	60
440-946-30M	71	441-650-42	50	441-839	75	444-2217-26	82	450-335	60
440-946-40	71	441-650-48	50	441-870-01	76	444-2217-40	82	450-336	60
440-946-40M	71	441-650-50DT	51	441-870-02	76	444-2225	83	450-337	60
440-992	71	441-650-58	50	441-881	76	444-2226	83	450-345	60
440-993	71	441-650-63DT	51	441-882	76	444-2227	84	450-346	60
440-994	71	441-655-25	50	441-891	76	444-2227L	84	450-347	60
441-192-01	72	441-655-30	50	441-892	76	444-2227R	84	450-348	60
441-192-02	72	441-655-30DT	51	441-900	108	444-2228	84	450-352	60
441-192-03	72	441-655-35DT	51	443-531-10	79	444-2261	85	450-353	60

NUMERISCHER INDEX
 NUMERIC INDEX
 ÍNDICE NÚMERO
 INDEX NUMERIQUE



450-354	60	450-835	63	470-270-03	90	471-210	97	480-119	104
450-355	60	450-837	63	470-270-04	90	471-230	97	480-120	104
450-370	60	450-840	63	470-270-05	90	471-270-45	98	480-121	104
450-371	60	450-842	63	470-270-06	90	471-270-50	98	480-122	104
450-373	60	450-843	63	470-270-07	90	471-270-55	98	480-123	104
450-390	61	450-844	64	470-271	88	471-271-35	98	480-124	104
450-410	69	450-846	64	470-301	89	471-271-40	98	480-125	104
450-412	69	450-847	64	470-302	91	471-271-45	98	480-126	104
450-413	69	450-848	64	470-303	91	471-271-50	98	480-127	104
450-420	69	450-852	63	470-304	91	471-271-55	98	480-128	104
450-421	69	450-856	65	470-341	89	471-275-45	98	480-129	104
450-490	69	450-857	65	470-362-01L	91	471-275-50	98	480-130	104
450-500	67	450-862	65	470-362-02L	91	471-275-55	98	480-131	104
450-501	67	450-880	63	470-362-03L	91	471-290	98	480-136	104
450-518	67	450-890	63	470-362-04L	91	471-291	98	480-138	104
450-519	67	450-891	63	470-363-01R	91	471-411	102	480-150	104
450-520	67	450-892	63	470-363-02R	91	471-413	102	480-151	104
450-530	67	450-900	65	470-363-03R	91	471-415	102	480-152	104
450-531	67	450-901	65	470-363-04R	91	471-500	100	480-153	104
450-532	67	450-905	65	470-371	91	471-501	100	480-154	104
450-540	67	450-910	64	470-372	91	471-502	100	480-160-06	105
450-542	67	450-914	64	470-373	91	471-510	100	480-160-08	105
450-548	67	451-111	54	470-374	91	471-511	100	480-160-10	105
450-560-01	66	451-120	54	470-375	91	471-512	100	480-160-12	105
450-560-02	66	451-300	55	470-390	92	471-520-00	99	480-160-14	105
450-560-03	66	451-310	55	470-392	92	471-521	99	480-160-16	105
450-560-04	66	451-313	55	470-396-04	92	471-522	99	480-160-18	105
450-560-05	66	451-314	55	470-397	92	471-523	99	480-160-20	105
450-560-06	66	451-318	55	470-399-04	92	471-528	99	480-160-22	105
450-560-07	66	451-321	55	470-424	86	471-600	101	480-160-22	105
450-560-08	66	451-323	55	470-425	86	471-601	101	480-160-24	105
450-562	68	451-325	55	470-426	86	471-602	101	480-160-26	105
450-563	68	451-331	55	470-427	86	471-603	101	480-160-28	105
450-564	68			470-440	86	471-604	101	480-160-30	105
450-564	68	470		470-445	86	471-611	101	480-170-06	105
450-565	68	470-102	87	470-446	86	471-612	101	480-170-08	105
450-565	68	470-103	87	470-446	86	471-613	101	480-170-10	105
450-566	68	470-130	87	470-460	86	471-614	101	480-170-12	105
450-574	66	470-131	87	470-500	93	471-615	101	480-170-14	105
450-575	66	470-132	87	470-501	93	471-616	101	480-170-16	105
450-586	66	470-133	87	470-503	93	471-629	101	480-170-18	105
450-587	66	470-200-01	90	470-505	93	471-630	101	480-170-20	105
450-589	66	470-200-02	90	470-507	93	471-631	101	480-170-22	105
450-590	66	470-200-03	90	470-515	93	471-632	101	480-170-24	105
450-591	66	470-201	88	470-522	93	471-633	101	480-170-26	105
450-592	66	470-210-01	90	470-630	94	471-634	101	480-170-28	105
450-593	66	470-210-02	90	470-631	94			480-170-30	105
450-594	66	470-210-03	90	470-660	94	480		480-525	130
450-700	58	470-210-04	90	470-721	95	480-099	104	480-526	130
450-701	58	470-210-05	90	470-726	95	480-100	104	481-700	129
450-702	58	470-210-06	90	470-727	95	480-101	104	481-702	129
450-703	58	470-210-07	90	470-810	95	480-102	104	481-720	129
450-715-21	58	470-211	88	470-817	95	480-103	104	481-722	129
450-716	58	470-221	88	470-850	95	480-104	104	481-730	129
450-718	58	470-261-01	90	470-900	96	480-105	104	481-791	106
450-732	58	470-261-02	90	470-901	96	480-106	104	481-900-20	108
450-733	58	470-261-03	90	470-910	96	480-107	104	481-900-30	108
450-822	63	470-261-04	90	470-911	96	480-108	104	481-900-40	108
450-823	63	470-261-05	90	471-106	96	480-109	104	481-900-50	108
450-824	63	470-270-01	90	471-200	97	480-110	104	481-900-60	108
450-832	63	470-270-02	90	471-205	97	480-111	104	481-901-20	108

481-945	109	482-5073-23	113	482-5191-18	120	485-6900	128
481-950	109	482-5092-18	114	482-5191-23	120	485-6902	128
481-951	109	482-5092-23	114	482-5192-18	120	485-6904	128
481-952	109	482-5093-18	114	482-5192-23	120	485-6910	128
481-953-20	109	482-5093-23	114	482-5193-18	120	485-6912	128
481-953-30	109	482-5110-18	115	482-5193-23	120	485-6914	128
481-953-40	109	482-5110-23	115	482-5250-23	121		
481-954-20	109	482-5111-18	115	482-600	122		
481-954-30	109	482-5111-23	115	482-601	122		
481-954-40	109	482-5112-18	115	482-602	122		
481-955-20	109	482-5112-23	115	482-603	122		
481-955-30	109	482-5113-18	115	482-604	122		
481-955-40	109	482-5113-23	115	482-605	122		
481-959	109	482-5114-18	115	482-606	122		
481-960	110	482-5114-23	115	482-607	122		
481-961	110	482-5115-18	115	482-608	123		
481-962-01	110	482-5115-23	115	482-610	123		
481-962-02	110	482-5120-18	116	482-612	123		
481-962-03	110	482-5120-23	116	482-613	123		
481-962-04	110	482-5121-18	116	482-614	123		
481-964-30	110	482-5121-23	116	482-618	123		
481-964-36	110	482-5122-18	116	482-620	124		
481-964-42	110	482-5122-23	116	482-621	124		
481-966-30	110	482-5123-18	116	485-6600	126		
481-966-36	110	482-5123-23	116	485-6610	126		
481-966-42	110	482-5124-18	116	485-6620	126		
481-968	110	482-5124-23	116	485-6630	126		
481-972	110	482-5125-18	116	485-6640	126		
482-5000-18	111	482-5125-23	116	485-6640H	126		
482-5000-23	111	482-5130-23	117	485-6650	126		
482-5001-18	111	482-5131-23	117	485-6660	126		
482-5001-23	111	482-5132-23	117	485-6810	127		
482-5002-18	111	482-5133-23	117	485-6812	127		
482-5002-23	111	482-5140-23	117	485-6814	127		
482-5003-18	111	482-5141-23	117	485-6820	127		
482-5003-23	111	482-5143-23	117	485-6822	127		
482-5004-18	111	482-5144-23	117	485-6824	127		
482-5004-23	111	482-5150-18	118	485-6830	127		
482-5005-18	111	482-5150-23	118	485-6832	127		
482-5005-23	111	482-5150H-18	118	485-6834	127		
482-5050-18	112	482-5150H-23	118	485-6840	127		
482-5050-23	112	482-5151-18	118	485-6842	127		
482-5050H-18	112	482-5151-23	118	485-6844	127		
482-5050H-23	112	482-5152-18	118	485-6850	127		
482-5051-18	112	482-5152-23	118	485-6850H	127		
482-5051-23	112	482-5153-18	118	485-6852	127		
482-5053-18	112	482-5153-23	118	485-6852H	127		
482-5053-23	112	482-5154-18	118	485-6854	127		
482-5054-18	112	482-5154-23	118	485-6854H	127		
482-5054-23	112	482-5170-18	119	485-6860	127		
482-5070-18	113	482-5170-23	119	485-6862	127		
482-5070-23	113	482-5170H-18	119	485-6864	127		
482-5070H-18	113	482-5170H-23	119	485-6870	127		
482-5070H-23	113	482-5171-18	119	485-6872	127		
482-5071-18	113	482-5171-23	119	485-6874	127		
482-5071-23	113	482-5172-18	119	485-6880	128		
482-5071H-18	113	482-5172-23	119	485-6882	128		
482-5071H-23	113	482-5173-18	119	485-6884	128		
482-5072-18	113	482-5173-23	119	485-6890	128		
482-5072-23	113	482-5190-18	120	485-6892	128		
482-5073-18	113	482-5190-23	120	485-6894	128		

Weitwinkel Otoskop, Ø 2,7mm, Arbeitslänge 50mm, autoklavierbar
Wide angle otoscope, Ø 2,7mm, working length 50mm, autoclavable
Otoscopio gran angular, Ø 2,7mm, longitud de trabajo 50mm, autoclavable
Otoscope grand angle, Ø 2,7mm, longueur de travail 50mm, autoclavable

- 230-81-000** 0° Blickrichtung / viewing direction /
dirección de vista / direction de vue 0°
230-81-030 30° Blickrichtung / viewing direction
dirección de vista / direction de vue 30°

Weitwinkel Otoskop, Ø 4,0mm, Arbeitslänge 50mm, autoklavierbar
Wide angle otoscope, Ø 4,0mm, working length 50mm, autoclavable
Otoscopio gran angular, Ø 4,0mm, longitud de trabajo 50mm, autoclavable
Otoscope grand angle, Ø 4,0mm, longueur de travail 50mm, autoclavable

- 230-82-000** 0° Blickrichtung / viewing direction
dirección de vista / direction de vue 0°
230-82-030 30° Blickrichtung / viewing direction
dirección de vista / direction de vue 30°



Weitwinkel Otoskop, Ø 4,0mm, Arbeitslänge 50mm, mit Ohrspekulum autoklavierbar
Wide angle otoscope, Ø 4,0mm, working length 50mm, with ear speculum, autoclavable
Otoscopio gran angular, Ø 4,0mm, longitud de trabajo 50mm, espéculo auricular, autoclavable
Otoscope grand angle, Ø 4,0mm, longueur de travail 50mm, spéculum auricul, autoclavable

- 230-82-000S** 0° Blickrichtung / viewing direction
dirección de vista / direction de vue 0°



Weitwinkel Sinuskop, Ø 2,7mm, Arbeitslänge 110mm, autoklavierbar
Wide angle sinuscope, Ø 2,7mm, working length 110mm, autoclavable
Sinuscopio gran angular, Ø 2,7mm, longitud de trabajo 110mm, autoclavable
Sinuscope grand angle, Ø 2,7mm, longueur de travail 110mm, autoclavable

- 230-34-000** 0° Blickrichtung / viewing direction
dirección de vista / direction de vue 0°
230-34-030 30° Blickrichtung / viewing direction
dirección de vista / direction de vue 30°
230-34-045 45° Blickrichtung / viewing direction
dirección de vista / direction de vue 45°
230-34-070 70° Blickrichtung / viewing direction
dirección de vista / direction de vue 70°



Weitwinkel Sinuskop, Ø 1,9mm, Arbeitslänge 69mm, autoklavierbar
Wide angle sinuscope, Ø 1,9mm, working length 69mm, autoclavable
Sinuscopio gran angular, Ø 1,9mm, longitud de trabajo 69mm, autoclavable
Sinuscope grand angle, Ø 1,9mm, longueur de travail 69mm, autoclavable

- 230-34-100** 0° Blickrichtung / viewing direction
dirección de vista / direction de vue 0°
230-34-130 30° Blickrichtung / viewing direction
dirección de vista / direction de vue 30°





Weitwinkel Sinuskop, Ø 2,7mm, Arbeitslänge 141mm, autoklavierbar
Wide angle sinuscope, Ø 2,7mm, working length 141mm, autoclavable
Sinuscopio gran angular, Ø 2,7mm, longitud de trabajo 141mm, autoclavable
Sinuscope grand angle, Ø 2,7mm, longueur de travail 141mm, autoclavable

- 230-59-000 0° Blickrichtung / viewing direction
dirección de vista / direction de vue 0°
- 230-59-030 30° Blickrichtung / viewing direction
dirección de vista / direction de vue 30°
- 230-59-045 45° Blickrichtung / viewing direction
dirección de vista / direction de vue 45°
- 230-59-070 70° Blickrichtung / viewing direction
dirección de vista / direction de vue 70°



Weitwinkel Sinuskop, Ø 2,7mm, Arbeitslänge 175mm, autoklavierbar
Wide angle sinuscope, Ø 2,7mm, working length 175mm, autoclavable
Sinuscopio gran angular, Ø 2,7mm, longitud de trabajo 175mm, autoclavable
Sinuscope grand angle, Ø 2,7mm, longueur de travail 175mm, autoclavable

- 230-58-000 0° Blickrichtung / viewing direction
dirección de vista / direction de vue 0°
- 230-58-030 30° Blickrichtung / viewing direction
dirección de vista / direction de vue 30°
- 230-58-045 45° Blickrichtung / viewing direction
dirección de vista / direction de vue 45°
- 230-58-070 70° Blickrichtung / viewing direction
dirección de vista / direction de vue 70°



Weitwinkel Sinuskop, Ø 2,7mm, Arbeitslänge 187mm, autoklavierbar
Wide angle sinuscope, Ø 2,7mm, working length 187mm, autoclavable
Sinuscopio gran angular, Ø 2,7mm, longitud de trabajo 187mm, autoclavable
Sinuscope grand angle, Ø 2,7mm, longueur de travail 187mm, autoclavable

- 230-35-000 0° Blickrichtung / viewing direction
dirección de vista / direction de vue 0°
- 230-35-030 30° Blickrichtung / viewing direction
dirección de vista / direction de vue 30°
- 230-35-070 70° Blickrichtung / viewing direction
dirección de vista / direction de vue 70°



Weitwinkel Sinuskop, Ø 4,0mm, Arbeitslänge 175mm, autoklavierbar
Wide angle sinuscope, Ø 4,0mm, working length 175mm, autoclavable
Sinuscopio gran angular, Ø 4,0mm, longitud de trabajo 175mm, autoclavable
Sinuscope grand angle, Ø 4,0mm, longueur de travail 175mm, autoclavable

- 230-436-000 0° Blickrichtung / viewing direction
dirección de vista / direction de vue 0°
- 230-436-030 30° Blickrichtung / viewing direction
dirección de vista / direction de vue 30°
- 230-36-045 45° Blickrichtung / viewing direction
dirección de vista / direction de vue 45°
- 230-436-070 70° Blickrichtung / viewing direction
dirección de vista / direction de vue 70°

Weitwinkel Sinuskop semiflex, Ø 2,7mm, Arbeitslänge 110mm, autoklavierbar
Wide angle sinuscope semiflex, Ø 2,7mm, working length 110mm, autoclavable
Sinuscopio semiflex gran angular, Ø 2,7mm, longitud de trabajo 110mm, autoclavable
Sinuscope semiflex grand angle, Ø 2,7mm, longueur de travail 110mm, autoclavable

230-34-000SF 0° Blickrichtung / viewing direction
dirección de vista / direction de vue 0°

230-34-030SF 30° Blickrichtung / viewing direction
dirección de vista / direction de vue 30°

Weitwinkel Sinuskop semiflex, Ø 2,7mm, Arbeitslänge 175mm, autoklavierbar
Wide angle sinuscope semiflex, Ø 2,7mm, working length 175mm, autoclavable
Sinuscopio semiflex gran angular, Ø 2,7mm, longitud de trabajo 175mm, autoclavable
Sinuscope semiflex grand angle, Ø 2,7mm, longueur de travail 175mm, autoclavable

230-58-000SF 0° Blickrichtung / viewing direction
dirección de vista / direction de vue 0°

230-58-030SF 30° Blickrichtung / viewing direction
dirección de vista / direction de vue 30°

Weitwinkel Sinuskop semiflex, Ø 4,0mm, Arbeitslänge 175mm, autoklavierbar
Wide angle sinuscope semiflex, Ø 4,0mm, working length 175mm, autoclavable
Sinuscopio semiflex gran angular, Ø 4,0mm, longitud de trabajo 175mm, autoclavable
Sinuscope semiflex grand angle, Ø 4,0mm, longueur de travail 175mm, autoclavable

230-36-000SF 0° Blickrichtung / viewing direction
dirección de vista / direction de vue 0°

230-36-030SF 30° Blickrichtung / viewing direction
dirección de vista / direction de vue 30°

230-36-045SF 45° Blickrichtung / viewing direction
dirección de vista / direction de vue 45°

230-36-070SF 70° Blickrichtung / viewing direction
dirección de vista / direction de vue 70°

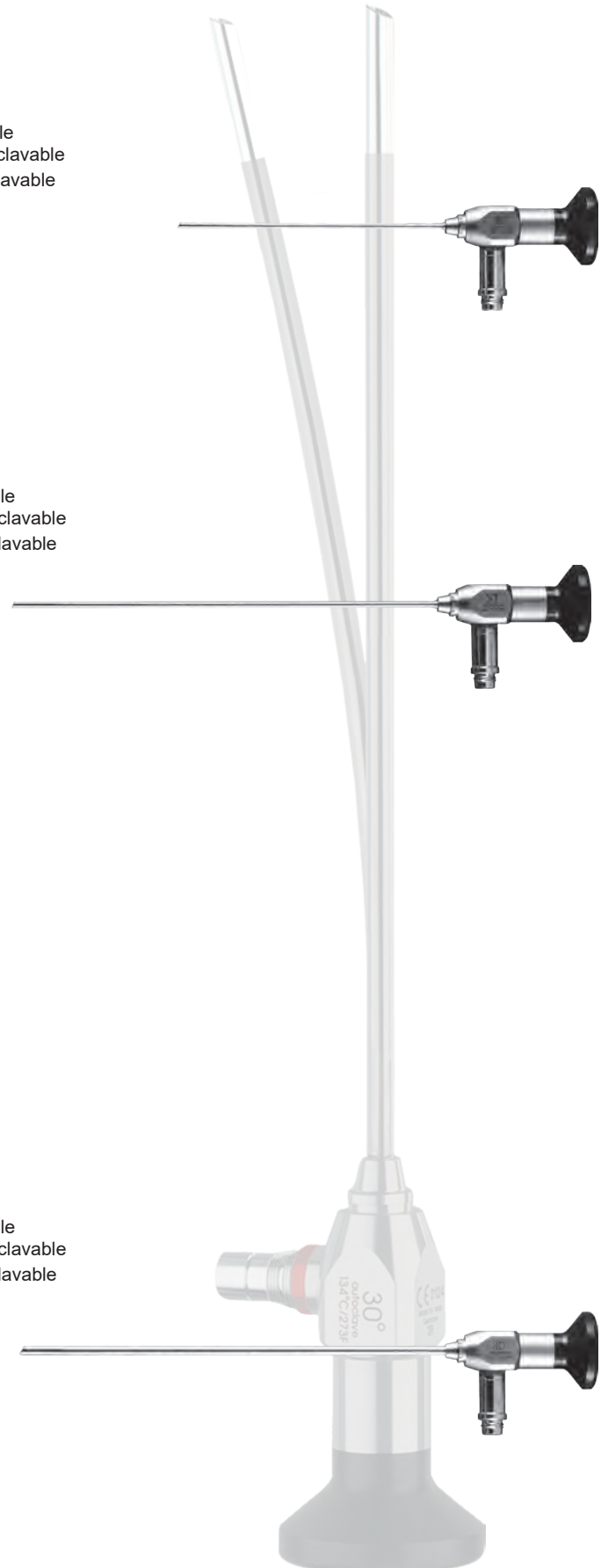



Mikrolaryngoskop, Ø 4,0mm, Arbeitslänge 175mm, autoklavierbar
Micro laryngoscope, Ø 4,0mm, working length 175mm, autoclavable
Micro laringoscopio, Ø 4,0mm, longitud de trabajo 175mm, autoclavable
Micro laryngoscope Ø 4,0mm, longueur de travail 175mm, autoclavable

230-63-170 70° Blickrichtung / viewing direction
dirección de vista / direction de vue 70°

230-63-190 90° Blickrichtung / viewing direction
dirección de vista / direction de vue 90°



Mikrolaryngoskop, Ø 5,8mm, Arbeitslänge 188mm, autoklavierbar
Micro laryngoscope, Ø 5,8mm, working length 188mm, autoclavable
Micro-laringoscopio Ø 5,8mm, longitud de trabajo 188mm, autoclavable
Micro-laryngoscope Ø 5,8mm, longueur de travail 188mm, autoclavable

230-63-270 70° Blickrichtung / viewing direction
dirección de vista / direction de vue 70°



Laryngoskop, seitliche Beleuchtung, Ø 8,0mm, Arbeitslänge 190mm, autoklavierbar
Laryngoscope, lateral illumination, Ø 8,0mm, working length 190mm, autoclavable
Laringoscopio, iluminación lateral, Ø 8,0mm, longitud de trabajo 190mm, autoclav.
Laryngoscope, illumination latérale, Ø 8,0mm, longueur de travail 190mm, autoclav.

230-64-070 70° Blickrichtung / viewing direction
dirección de vista / direction de vue 70°



Laryngoskop, seitliche Beleuchtung, Ø 10mm, Arbeitslänge 190mm, autoklavierbar
Laryngoscope, lateral illumination, Ø 10mm, working length 190mm, autoclavable
Laringoscopio, iluminación lateral, Ø 10mm, longitud de trabajo 190mm, autoclavable
Laryngoscope, illumination latérale, Ø 10mm, longueur de travail 190mm, autoclav.

230-63-070 70° Blickrichtung / viewing direction
dirección de vista / direction de vue 70°

230-63-090 90° Blickrichtung / viewing direction
dirección de vista / direction de vue 90°

Telelaryngo Pharyngoskop, seitliche Beleuchtung, Ø 10mm, Arbeitslänge 200mm, einlegbar
Telelaryngo Pharyngoscope, lateral illumination, Ø 10mm, working length 200mm, soakable
Tele-laringoscopio ???, Ø 10mm, longitud de trabajo 200mm, sumergible
Télé-laryngoscope ???, Ø 10mm, longueur de travail 200mm, immergeable

- 230-62-070** 70° Blickrichtung / viewing direction
dirección de vista / direction de vue 70°
230-62-090 90° Blickrichtung / viewing direction
dirección de vista / direction de vue 90°



FLAT

Laryngoskop, seitliche Beleuchtung, Ø 12,4x7,2mm, Arbeitslänge 184mm, autoklavierbar
Laryngoscope, lateral illumination, Ø 12,4x7,2mm, working length 184mm, autoclavable
Laringoscopio, iluminación lateral, Ø 12,4x7,2mm, longitud de trabajo 184mm, autoclavable
Laryngoscope, illumination latérale, Ø 12,4x7,2mm, longueur de travail 184mm, autoclav.

- 230-63-370** 70° Blickrichtung / viewing direction
dirección de vista / direction de vue 70°
230-63-390 90° Blickrichtung / viewing direction
dirección de vista / direction de vue 90°



FLAT

Telelaryngo Pharyngoskop, seitliche Beleuchtung, Ø 12,4x7,2mm, Arbeitslänge 200mm, einlegbar
Telelaryngo Pharyngoscope, lateral illumination, Ø 12,4x7,2mm, working length 200mm, soakable
Tele-laringoscopio ???, Ø 12,4x7,2mm, longitud de trabajo 200mm, sumergible
Télé-laryngoscope ???, Ø 12,4x7,2mm, longueur de travail 200mm, immergeable

- 230-62-370** 70° Blickrichtung / viewing direction
dirección de vista / direction de vue 70°
230-62-390 90° Blickrichtung / viewing direction
dirección de vista / direction de vue 90°



Bronchoskop, Ø 2,9mm, Arbeitslänge 303mm, autoklavierbar
Bronchoscope, Ø 2,9mm, working length 303mm, autoclavable
Broncoscopio, Ø 2,9mm, longitud de trabajo 303mm, autoclavable
Bronchoscope, Ø 2,9mm, longueur de travail 303mm, autoclavable

- 230-84-000** 0° Blickrichtung / viewing direction
dirección de vista / direction de vue 0°
230-84-030 30° Blickrichtung / viewing direction
dirección de vista / direction de vue 30°



Bronchoskop, Ø 2,9mm, Arbeitslänge 365mm, autoklavierbar
Bronchoscope, Ø 2,9mm, working length 365mm, autoclavable
Broncoscopio, Ø 2,9mm, longitud de trabajo 365mm, autoclavable
Bronchoscope, Ø 2,9mm, longueur de travail 365mm, autoclavable

- 230-84-100** 0° Blickrichtung / viewing direction
dirección de vista / direction de vue 0°
230-84-130 30° Blickrichtung / viewing direction
dirección de vista / direction de vue 30°



Bronchoskop, Ø 5,5mm, Arbeitslänge 490mm, autoklavierbar
Bronchoscope, Ø 5,5mm, working length 490mm, autoclavable
Broncoscopio, Ø 5,5mm, longitud de trabajo 490mm, autoclavable
Bronchoscope, Ø 5,5mm, longueur de travail 490mm, autoclavable

- 230-85-000** 0° Blickrichtung / viewing direction
dirección de vista / direction de vue 0°
230-85-030 30° Blickrichtung / viewing direction
dirección de vista / direction de vue 30°



Oesophagoskop, Ø 5,5mm, Arbeitslänge 530mm, autoklavierbar
Oesophagoscope, Ø 5,5mm, working length 530mm, autoclavable
Esofagoscopio, Ø 5,5mm, longitud de trabajo 530mm, autoclavable
Oesophagoscope, Ø 5,5mm, longueur de travail 530mm, autoclavable

- 230-86-000** 0° Blickrichtung / viewing direction
dirección de vista / direction de vue 0°
230-86-030 30° Blickrichtung / viewing direction
dirección de vista / direction de vue 30°



Naso-Pharyngoskop, 18.000 Pixels, Ø 2,8mm, Arbeitslänge 300mm, Biegung 150° aufwärts 150° abwärts, Länge des beweglichen Arbeitendes 35mm, 0° Blickrichtung, Sichtfeld 70°, Tiefenschärfe 5mm bis 20mm

Naso-Pharyngoscope, 18.000 pixels, Ø 2,8mm, working length 300mm, deflection up 150° down 150°, length of the moveable tip 35mm, direction of view 0°, field of view 70°, depth of focus 5mm bis 20mm

Naso-faringoscopio, 18.000 píxel, Ø 2,8mm, longitud de trabajo 300mm, flexión 150° arriba 150° abajo, longitud de la punta de trabajo móvil 35mm, 0° dirección de vista, campo visual 70°, profundidad de campo 5mm bis 20mm

Naso-pharyngoscope, 18.000 pixels, Ø 2,8mm, longueur de travail 300mm, courbé 150° en haut 150° en bas, longueur du bout de travail mobile 35mm, 0° direction de vue, champ de vision 70°, profondeur de champ 5mm bis 20mm

230-70-280



Naso-Pharyngoskop, 18.000 Pixels, Ø 3,4mm, Arbeitslänge 300mm, Biegung 150° aufwärts 150° abwärts, Länge des beweglichen Arbeitendes 35mm, 0° Blickrichtung, Sichtfeld 70°, Tiefenschärfe 5mm bis 20mm

Naso-Pharyngoscope, 18.000 pixels, Ø 3,4mm, working length 300mm, deflection up 150° down 150°, length of the moveable tip 35mm, direction of view 0°, field of view 70°, depth of focus 5mm bis 20mm

Naso-faringoscopio, 18.000 píxel, Ø 3,4mm, longitud de trabajo 300mm, flexión 150° arriba 150° abajo, longitud de la punta de trabajo móvil 35mm, 0° dirección de vista, campo visual 70°, profundidad de campo 5mm bis 20mm

Naso-pharyngoscope, 18.000 pixels, Ø 3,4mm, longueur de travail 300mm, courbé 150° en haut 150° en bas, longueur du bout de travail mobile 35mm, 0° direction de vue, champ de vision 70°, profondeur de champ 5mm bis 20mm

230-70-340

Verschiedene Farben durch Eloxalbeschichtung oder eine graue Teflonbeschichtung sind auf Anfrage erhältlich (Standard Farbe Gold)

Different colours by anodised coating or a grey PTFE coating available on request (standard colour gold)

Diferentes colores con recubrimiento anodizado o un recubrimiento de teflón gris están disponibles bajo petición (color estandard dorado)

Divers couleurs par revêtement d'oxydation anodique, ou gris par couche PTFE, disponibles sur demande (couleur standard: or)

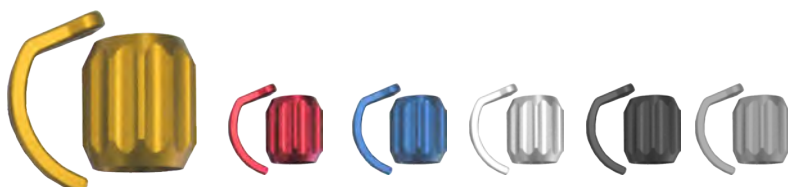

ALUMINIUM

mit Dämpfer / with clamp / con sordina / avec sourdine

430-101	C	64Hz
430-102	C	128Hz
430-103	C1	256Hz



ALUMINIUM

430-104	C2	512Hz
430-105	C3	1024Hz
430-106	C4	2048Hz
430-107	C5	4096Hz



HARTMANN

430-112	C	128Hz
430-113	C1	256Hz
430-114	C2	512Hz
430-115	C3	1024Hz
430-116	C4	2048Hz
430-117	C5	4096Hz



LUCAE

mit Fuß / with foot / con pie / avec pied

430-132	C	128Hz
430-133	C1	256Hz
430-134	C2	512Hz
430-135	C3	1024Hz
430-136	C4	2048Hz
430-137	C5	4096Hz



430-144	a1	440Hz
---------	----	-------

mit Fuß / with foot / con pie / avec pied



ALUMINIUM

im Kunststoffkoffer / in plastic box

en estuche de plástico / dans boîte de plastique

430-100-05

bestehend aus / consisting of
compuesto de / composé de

430-102	C	128Hz
430-103	C1	256Hz
430-104	C2	512Hz
430-105	C3	1024Hz
430-106	C4	2048Hz

HARTMANN

im Kunststoffkoffer / in plastic box

en estuche de plástico / dans boîte de plastique

430-120-05

bestehend aus / consisting of
compuesto de / composé de

430-112	C	128Hz
430-113	C1	256Hz
430-114	C2	512Hz
430-115	C3	1024Hz
430-115	C4	2048Hz



Ohrspritze, aus Metall Luer-Lock,
mit 2 Ansätzen und Spritzschuttteller
Ear syringe, metal, luer-lock,
with 2 tips and protection shield
Jeringa de oído de metal, luer-lock
con 2 puntas y placa protección
Seringue auriculaire en métal, luer-lock
avec 2 embouts et plaque de protection

430-900 50 ml

430-901 75 ml

430-902 100 ml

430-903 150 ml

Aufsatz olivenförmig, Luer Lock
Tip olive end, luer lock
Punta de oliva, luer-lock
Embout pointe olive, luer-lock

430-905

Aufsatz konisch, Luer Lock
Tip cone end, luer lock
Punta conica, luer-lock
Embout pointe conique, luer-lock

430-906

Spritzschutz-Teller, Luer Lock
Protection shield, luer lock
Placa de protección, luer-lock
Plaque de protection, luer-lock

430-908





HOLMGREN

Selbsthaltender Ohrtrichter mit quer gerieften Trichterblättern, 32mm, schwarz

Selfretaining ear speculum with slotted blades, 32mm, black

Especulo auricular autoretenido con válvulas estriadas transversal, 32mm negro

Spéculum auriculaire autostatique avec valves striées en travers, 32mm, noir

	Fig.	Ømm außen Ømm outer Ømm exterior Ømm extérieur
430-391	1	5,0mm
430-392	2	6,0mm
430-393	3	7,0mm

HARTMANN

Ohrspekulum für Kinder, 33mm, rund, matt
Ear speculum for children, 33mm, round, matt finished
Especulo auricular para niños, 33mm, redondo, mate
Spéculum auriculaire pour enfants, 33mm, rond, mat

	Fig.	Ømm außen Ømm outer Ømm exterior Ømm extérieur	Satz set juego jeu
430-181	1	2,0	x
430-182	2	3,0	x
430-183	3	4,0	x
			430-180-00



HARTMANN

Ohrspekulum, 36mm, rund, matt
Ear speculum, 36mm, round, matt finished
Especulo auricular 36mm, redondo, mate
Spéculum auriculaire, 36mm, rond, mat

	Fig.	Ømm außen Ømm outer Ømm exterior Ømm extérieur	Satz set juego jeu	Satz set juego jeu	Satz set juego jeu
430-200	0	3,0			x
430-201	1	4,0	x	x	x
430-202	2	5,0	x	x	x
430-203	3	6,0	x	x	
430-204	4	7,5		x	
			430-205-00	430-206-00	430-208-00



HARTMANN

Ohrspekulum, 36mm, rund, schwarz
Ear speculum, 36mm, round, black
Especulo auricular, 36mm, redondo, negro
Spéculum auriculaire, 36mm, rond, noir

	Fig.	Ømm außen Ømm outer Ømm exterior Ømm extérieur	Satz set juego jeu	Satz set juego jeu	Satz set juego jeu
430-340	0	3,0			x
430-341	1	4,0	x	x	x
430-342	2	5,0	x	x	x
430-343	3	6,0	x	x	
430-344	4	7,5		x	
			430-345-00	430-346-00	430-347-00

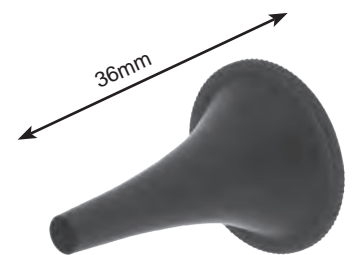

HARTMANN

Ohrspekulum zur Nachbehandlung, 36mm, rund, schwarz
Ear speculum, for post operative check-up, 36mm, round, black
Especulo auricular para tratamiento postoperativo, 36mm, negro
Spéculum auriculaire pour traitement post-opératoire, 36mm, noir

	Fig.	Ømm außen Ømm outer Ømm exterior Ømm extérieur
430-348	1	9,0
430-349	2	10,0

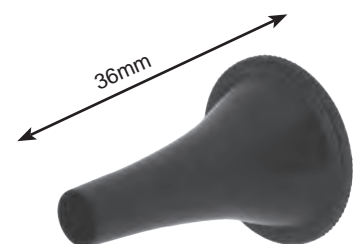



POLITZER

Ohrspekulum für Kinder, 27mm, rund, matt
Ear speculum for children, 27mm, round, matt finished
Especulo auricular para niños, 27mm, redondo, mate
Spéculum auriculaire pour enfants, 27mm, rond, mat

	Fig.	Ømm außen Ømm outer Ømm exterior Ømm extérieur	Satz set juego jeu
430-171	1	3,0	x
430-172	2	4,0	x
430-173	3	5,0	x
			430-170-00

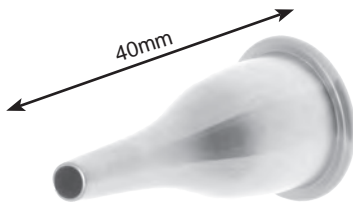

GRUBER

Ohrspekulum, 40mm, oval, matt
Ear speculum, 40mm, oval, matt finished
Especulo auricular, 40mm, ovalado, mate
Spéculum auriculaire, 40mm ovale, mat

	Fig.	Ømm außen Ømm outer Ømm exterior Ømm extérieur	Satz set juego jeu	Satz set juego jeu
430-246	1	3,8 x 4,8	x	x
430-247	2	4,8 x 5,8	x	x
430-248	3	6,0 x 7,2	x	x
430-249	4	7,0 x 8,2		x
			430-244-00	430-245-00

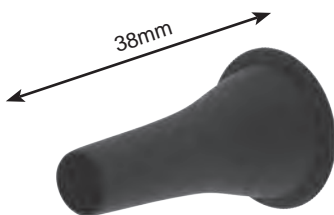

ZOELLNER

Ohrspekulum, 38mm, oval, Aluminium, schwarz
Ear speculum, 38mm, oval, aluminium, black
Especulo auricular, 38mm, ovalado, aluminio, negro
Spéculum auriculaire, 38mm, ovale, aluminium, noir

	Fig.	Ømm außen Ømm outer Ømm exterior Ømm extérieur	Satz set juego jeu
430-2651	1	5,5 x 6,5	x
430-2652	2	6,5 x 7,5	x
430-2653	3	7,5 x 8,5	x
430-2654	4	8,5 x 9,5	x
430-2655	5	9,5 x 10,5	x
430-2656	6	10,5 x 11,5	x
			430-260-00

FARRIOR

Ohrspekulum, 43mm, rund, matt
 Ear speculum, 43mm, round, matt finished
 Especulo auricular, 43mm, redondo, mate
 Spéculum auriculaire, 43mm, rond, mat

	Fig.	Ømm außen Ømm outer Ømm exterior Ømm extérieur
430-2661	1	4,1
430-2662	2	5,1
430-2663	3	5,6
430-2664	4	6,1
430-2665	5	6,6
430-2666	6	7,1
430-2667	7	7,5
430-2668	8	8,0
430-2669	9	8,5

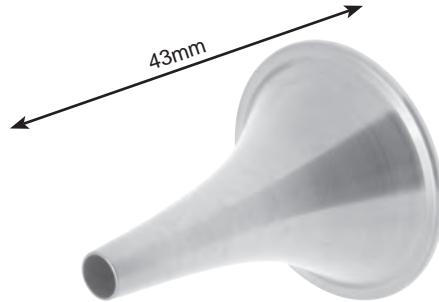

FARRIOR

Ohrspekulum, 43mm, oval, Ende 20° abgeschrägt, matt
 Ear speculum, 43mm, oval, oblique distal end 20° matt finished
 Especulo auricular, 43mm, ovalado, punta biselada 20°, mate
 Spéculum auriculaire, 43mm, ovale, pointe biseautée 20°, mat

	Fig.	Ømm außen Ømm outer Ømm exterior Ømm extérieur
430-281	1	3,8 x 4,8
430-282	2	4,8 x 5,8
430-283	3	5,3 x 6,3
430-284	4	5,8 x 6,8
430-285	5	6,3 x 7,3
430-286	6	6,8 x 7,8
430-287	7	7,3 x 8,3
430-288	8	7,8 x 8,8
430-289	9	8,3 x 9,3

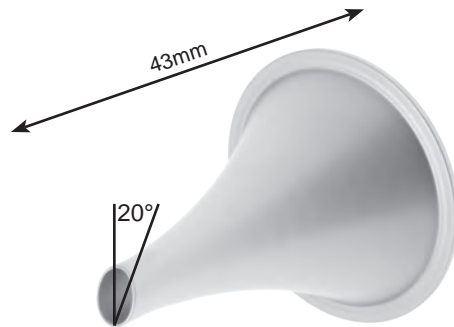

FARRIOR

Ohrspekulum, 43mm, oval, Ende 35° abgeschrägt, matt
 Ear speculum, 43mm, oval, oblique distal end 35° matt finished
 Especulo auricular, 43mm, ovalado, punta biselada 35°, mate
 Spéculum auriculaire, 43mm, pointe biseautée 35°, mat

	Fig.	Ømm außen Ømm outer Ømm exterior Ømm extérieur
430-291	1	3,8 x 4,8
430-292	2	4,8 x 5,8
430-293	3	5,3 x 6,3
430-294	4	5,8 x 6,8
430-295	5	6,3 x 7,3
430-296	6	6,8 x 7,8
430-297	7	7,3 x 8,3
430-298	8	7,8 x 8,8
430-299	9	8,3 x 9,3

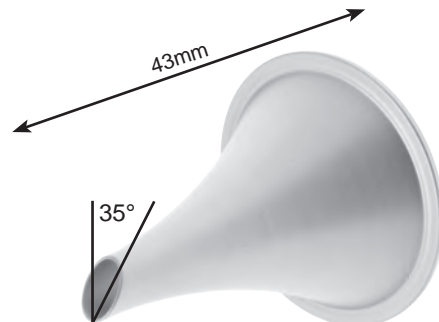

ELCON

HNO - ENT - ORL

BUCK

Ohrkürette, Gesamtlänge 150mm
 Ear curette, total length 150mm
 Cureta auricular, longitud total 150mm
 Curette auriculaire, longueur totale 150mm

Fig.	Ø außen Ø outer Ø exterior Ø extérieur	gerade, scharf straight, sharp recta, cortante droit, trachante	gebogen, scharf curved, sharp curva, cortante courbée, trachante	gerade, stumpf straight, blunt recta, romo droit, mousse	gebogen, stumpf curved, blunt curva, romo courbée, mousse
00	1,5mm	430-507	430-517	430-527	430-537
0	2,0mm	430-500	430-510	430-520	430-530
1	2,5mm	430-501	430-511	430-521	430-531
2	3,0mm	430-502	430-512	430-522	430-532
3	3,5mm	430-503	430-513	430-523	430-533
4	4,0mm	430-504	430-514	430-524	430-534

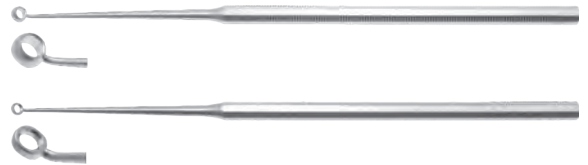

SHAPLEIGH

Ohrkürette gerieft, Gesamtlänge 155mm
 Ear curette serrated, total length 155mm
 Cureta auricular, estriada, longitud total 155mm
 Curette auriculaire, striée, longueur totale 155mm

- 430-540** Fig. 1 gerade / straight
recta / droite
- 430-541** Fig. 2 gerade / straight
recta / droite
- 430-542** Fig. 3 gebogen / curved
curva / courbée
- 430-543** Fig. 4 gebogen / curved
curva / courbée



SNELLEN

Ohrschlinge, gerieft, Gesamtlänge 160mm
 Ear loop, serrated, total length 160mm
 Asa auricular, estriada, longitud total 160mm
 Anse auriculaire, striée, longueur totale 160mm

- 430-544-01** Fig. 1
- 430-544-02** Fig. 2
- 430-544-03** Fig. 3



BILLEAU

Ohrschlinge, Gesamtlänge 165mm
 Ear loop, total length 165mm
 Asa auricular, longitud total 165mm
 Anse auriculaire, longueur totale 165mm

- 430-545** Fig. 1
- 430-546** Fig. 2
- 430-547** Fig. 3





LUCAE

Ohrhäkchen, Gesamtlänge 140mm
Ear hook, total length 140mm
Gancho auricular, longitud total 140mm
Crochet auriculaire, longueur totale 140mm

430-576 Fig. 1

430-577 Fig. 2

430-578 Fig. 3



WAGNER

Ohrhäkchen, Gesamtlänge 140mm
Ear hook, total length 140mm
Gancho auricular, longitud total 140mm
Crochet auriculaire, longueur totale 140mm

430-560-01 Fig. 1

430-560-02 Fig. 2

430-560-03 Fig. 3

430-560-04 Fig. 4

430-560-05 Fig. 5

430-560-06 Fig. 6

430-560-07 Fig. 7



Hakensonde mit Knopf 45°, Gesamtlänge 155mm
Seeker with ball end 45°, total length 155mm
Sonda de gancho abotonada 45, longitud total 155mm
Sonde crochet avec boule a l'extremite 45° longueur totale 155mm

430-559



GROSS

Ohrhäkchen / -löffel, Gesamtlänge 120mm
Ear hook / spoon, total length 120mm
Gancho / cureta auricular, longitud total 120mm
Crochet / curette auriculaire, longueur totale 120mm

430-580 Haken stumpf / hook blunt

Gancho romo / crochet mousse

430-581 Haken spitz / hook pointed

Gancho agudo / crochet pointu



FORMBY

Ohrhäkchen / -löffel, Gesamtlänge 180mm
Ear hook / spoon, total length 180mm
Gancho / cureta auricular, longitud total 180mm
Crochet / curette auriculaire, longueur totale 180mm

430-584



ZAUFAL

Ohrhebel, Breite 3,0mm, Gesamtlänge 160mm
Ear spatula, width 3,0mm, total length 160mm
Espátula auricular, anchura 3,0mm, longitud total 160mm
Spatule auriculaire, largeur 3,0mm, longueur totale 160mm

430-594

POLITZER

Parazentesenadel, gerade, Gesamtlänge 180mm
Tympanum perforator, straight, total length 180mm
Aguja para paracentesis, recta, longitud total 180mm
Aiguille à paracentèse, droite, longueur totale 180mm

430-610



POLITZER

Parazentesenadel, kniegebogen, Gesamtlänge 160mm
Tympanum perforator, angled, total length 160mm
Aguja para paracentesis, angulado, longitud total 160mm
Aiguille à paracentèse, coudée, longueur totale 160mm

430-611 vertikal / vertical

vertical / verticale

430-613 horizontal / horizontal

horizontal / horizontale



LUCAE

Parazentesenadel, bajonett, Gesamtlänge 180mm
Tympanum perforator, bayonet, total length 180mm
Aguja para paracentesis, bayoneta, longitud total 180mm
Aiguille à paracentèse, baïonnette, longueur totale 180mm

430-631 für Erwachsene / for adults
para adultos / pour adultes



LUCAE

Parazentesenadel, bajonett, Gesamtlänge 160mm
Tympanum perforator, bayonet, total length 160mm
Aguja para paracentesis, bayoneta, longitud total 160mm
Aiguille à paracentèse, baïonnette, longueur totale 160mm

430-630 für Kinder / for children
para niños / pour enfants



SEXTON-GERZOG

Ohrmesser, bajonett, Gesamtlänge 170mm
Ear knife, bayonet, total length 170mm
Cuchillo auricular, bayoneta, longitud total 170mm
Couteau auriculaire, baïonnette, longueur totale 170mm

430-625



AGNEW

Parazentesenadel, kniegebogen, Gesamtlänge 175mm
Tympanum perforator, angled, total length 175mm
Aguja para paracentesis, angulado, longitud total 175mm
Aiguille à paracentèse, coudée, longueur totale 175mm

430-643





KRAUSE

Ohrenpolypenschnürer 180mm
Ear snare 180mm
Pólipotomo 180mm
Serre noeud pour polypes auriculaires 180mm

430-700



Schnürerdraht für Ohrenpolypenschnürer, Packung à 12 Stück
Ear snare wires, 1 dozen
Alambre para polipotomo, paquete de 12 unidades
Anses pour serre noeuds, paquet de 12 pièces

430-730-20 Ø 0,20mm, 75mm

430-730-25 Ø 0,25mm, 75mm

430-730-30 Ø 0,30mm, 75mm



Schnürerdraht für Ohrenpolypenschnürer, Packung à 100 Stück
Ear snare wires, 100 pieces
Alambre para polipotomo, paquete de 100 unidades
Anses pour serre noeuds, paquet de 100 pièces

430-732-20 Ø 0,20mm, 75mm

430-732-25 Ø 0,25mm, 75mm

430-732-30 Ø 0,30mm, 75mm

TILLEY

Ohrtampon Zange, Gesamtlänge 140mm
Ear tampon forceps, total length 140mm
Pinza de tamponaje, longitud total 140mm
Pince à tampons, longueur totale 140mm

431-063 Arbeitslänge 60mm
working length 60mm
longitud de trabajo 60mm
longueur de travail 60mm

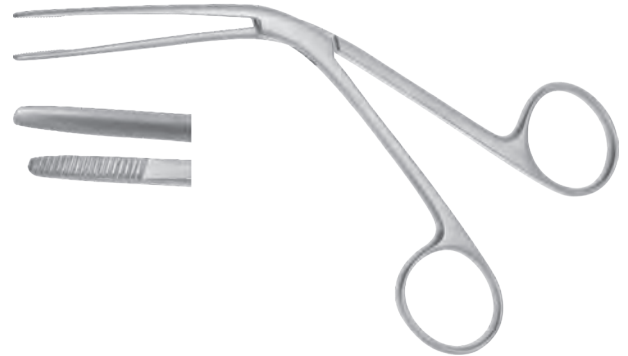

HARTMANN

Ohrtampon Zange, Gesamtlänge 125mm, schlankes Modell
Ear tampon forceps, total length 125mm, delicate pattern
Pinza de tamponaje, longitud total 125mm, modelo fino
Pince à tampons, longueur totale 125mm, modèle fin

431-070 Arbeitslänge 60mm
working length 60mm
longitud de trabajo 60mm
longueur de travail 60mm



HARTMANN

Ohrtampon Zange, Gesamtlänge 145mm
Ear tampon forceps, total length 145mm
Pinza de tamponaje, longitud total 145mm
Pince à tampons, longueur totale 145mm

431-072 Arbeitslänge 60mm
working length 60mm
longitud de trabajo 60mm
longueur de travail 60mm





TROELTSCH

Anatomische Ohrpinzette, Gesamtlänge 130mm
Ear dressing forceps, total length 130mm
Pinza auricular de disección, longitud total 130mm
Pince auriculaire à dissection, longueur totale 130mm

141-300 Arbeitslänge 75mm
working length 75mm
longitud de trabajo 75mm
longueur de travail 75mm



TROELTSCH

Anatomische Ohrpinzette, Gesamtlänge 110mm
Ear dressing forceps, total length 110mm
Pinza auricular de disección, longitud total 110mm
Pince auriculaire à dissection, longueur totale 110mm

141-301 Arbeitslänge 55mm
working length 55mm
longitud de trabajo 55mm
longueur de travail 55mm



LUCAE

Anatomische Ohrpinzette, Gesamtlänge 140mm
Ear dressing forceps, total length 140mm
Pinza auricular de disección, longitud total 140mm
Pince auriculaire à dissection, longueur totale 140mm

141-330 Arbeitslänge 60mm
working length 60mm
longitud de trabajo 60mm
longueur de travail 60mm



JANSEN

Anatomische Ohrpinzette, Gesamtlänge 165mm
Ear dressing forceps, total length 165mm
Pinza auricular de disección, longitud total 165mm
Pince auriculaire à dissection, longueur totale 165mm

141-340 Arbeitslänge 70mm
working length 70mm
longitud de trabajo 70mm
longueur de travail 70mm



GRUENWALD

Anatomische Ohrpinzette, Gesamtlänge 200mm
Ear dressing forceps, total length 200mm
Pinza auricular de disección, longitud total 200mm
Pince auriculaire à dissection, longueur totale 200mm

141-344 Arbeitslänge 100mm
working length 100mm
longitud de trabajo 100mm
longueur de travail 100mm

HARTMANN-WULLSTEIN

Ohrzängchen, gerade, Maulteil 0,8x6mm gerieft
Ear forceps, straight, jaws 0,8x6mm serrated
Pinza auricular, recta, boca 0,8x6mm estriada
Pince auriculaire, droite, mors 0,8x6mm striée

431-080 Arbeitslänge 80mm / working length 80mm
longitud de trabajo 80mm / longueur de travail 80mm



HARTMANN

Ohrzängchen, gerade, Maulteil 1,6x8mm gerieft
Ear forceps, straight, jaws 1,6x8mm serrated
Pinza auricular, recta, boca 1,6x8mm estriada
Pince auriculaire, droite, mors 1,6x8mm striée

431-010 Arbeitslänge 80mm / working length 80mm
longitud de trabajo 80mm / longueur de travail 80mm

431-011 Arbeitslänge 145mm / working length 145mm
longitud de trabajo 145mm / longueur de travail 145mm



HARTMANN-NOYES

Ohrzängchen, gerade, Maulteil 2,8x9mm gerieft
Ear forceps, straight, jaws 2,8x9mm serrated
Pinza auricular, recta, boca 2,8x9mm estriada
Pince auriculaire, droite, mors 2,8x9mm striée

431-013 Arbeitslänge 80mm / working length 80mm
longitud de trabajo 80mm / longueur de travail 80mm

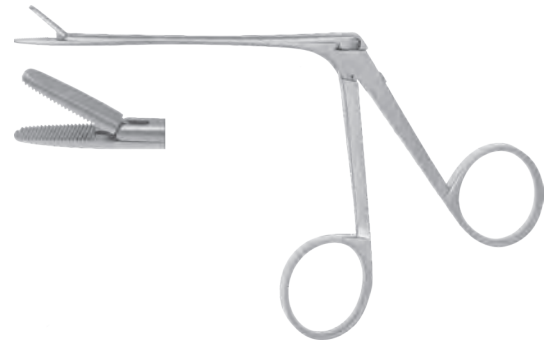

HARTMANN

Ohrzängchen, gerade, 1x2 Zähne gerieft
Ear forceps, straight, 1x2 teeth serrated
Pinza auricular, recta, 1x2 dientes, estriada
Pince auriculaire, droite, 1x2 griffes, striée

431-015 Arbeitslänge 80mm / working length 80mm
longitud de trabajo 80mm / longueur de travail 80mm

431-016 Arbeitslänge 145mm / working length 145mm
longitud de trabajo 145mm / longueur de travail 145mm





HARTMANN-WULLSTEIN

Ohrzängchen, gerade, runder Löffel, Arbeitslänge 80mm
Ear forceps, straight, round cup, working length 80mm
Pinza auricular, recta, cuchara redonda, longitud de trabajo 80mm
Pince auriculaire, droite, cuillère ronde, longueur de travail 80mm

431-020-10 Ø 1,0mm

HARTMANN

Ohrzängchen, gerade, runder Löffel, Arbeitslänge 80mm
Ear forceps, straight, round cup, working length 80mm
Pinza auricular, recta, cuchara redonda, longitud de trabajo 80mm
Pince auriculaire, droite, cuillère ronde, longueur de travail 80mm

431-020-15 Ø 1,5mm

431-020-20 Ø 2,0mm

431-020-25 Ø 2,5mm

431-020-30 Ø 3,0mm



STRUEMPEL

Ohrzängchen, oval gefenstert 2,5x6,0mm, Arbeitslänge 80mm
Ear forceps, oval fenestrated 2,5x6,0mm, working length 80mm
Pinza auricular, fenestrada oval, 2,5x6,0mm, longitud de trabajo 80mm
Pince auriculaire, fenêtrée ovale 2,5x6,0mm longueur de travail 80mm

431-030 gerade / straight / recta / droite

431-031 45° aufgebogen / 45° curved up

45° curva hacia arriba / 45° courbé vers le haut

431-033 90° aufgebogen / 90° curved up

90° curva hacia arriba / 90° courbé vers le haut

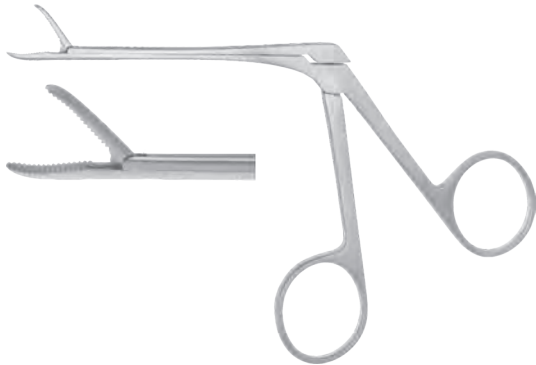

WEINGAERTNER

Ohrzängchen, gerade, gerieft
Ear forceps, straight, serrated
Pinza auricular, recta, estriada
Pince auriculaire, droite, striée

431-040 Arbeitslänge 80mm / working length 80mm
longitud de trabajo 80mm / longueur de travail 80mm



HOFFMANN

Ohrzängchen, Ø 2,0mm durchschneidend, Arbeitslänge 80mm
Ear forceps, Ø 2,0mm through-cutting, working length 80mm
Pinza auricular, Ø 2,0mm cortante, longitud de trabajo 80mm
Pince auriculaire, Ø2,0mm coupante, longueur de travail 80mm

431-050 gerade / straight / recta / droite

LUER

Saugrohr konisch, Arbeitslänge 175mm
Suction tube conical, working length 175mm
Canula de aspiración cónica, longitud de trabajo 175mm
Canule d'aspiration conique, longueur de travail 175mm

181-122 Ø 3,0mm



LUER

Saugrohr konisch, Arbeitslänge 115mm
Suction tube conical, working length 115mm
Canula de aspiración cónica, longitud de trabajo 115mm
Canule d'aspiration conique, longueur de travail 115mm

181-123 Ø 3,0mm

181-124 Ø 3,5mm

Saugrohr konisch, Arbeitslänge 130mm
Suction tube conical, working length 130mm
Canula de aspiración cónica, longitud de trabajo 130mm
Canule d'aspiration conique, longueur de travail 130mm

181-126 Ø 4,5mm



PLESTER

Saugrohr mit Unterbrecher, Arbeitslänge 140mm
Suction tube with suction control, working length 140mm
Canula de aspiración con válvula, longitud de trabajo 140mm
Canule d'aspiration avec soupape, longueur de travail 140mm

180-900 5Fr., Charr. / Ø 1,6mm

180-901 6Fr., Charr. / Ø 2,0mm

180-902 8Fr., Charr. / Ø 2,6mm

180-903 9Fr., Charr. / Ø 3,0mm



FRAZIER-FERGUSON

Saugrohr mit Unterbrecher, Arbeitslänge 110mm
Suction tube with suction control, working length 110mm
Canula de aspiración con válvula, longitud de trabajo 110mm
Canule d'aspiration avec soupape, longueur de travail 110mm

341-929 5Fr., Charr. / Ø 1,6mm

341-930 6Fr., Charr. / Ø 2,0mm

341-932 7Fr., Charr. / Ø 2,3mm

341-931 8Fr., Charr. / Ø 2,6mm

341-933 9Fr., Charr. / Ø 3,0mm

341-934 10Fr., Charr. / Ø 3,3mm

341-935 11Fr., Charr. / Ø 3,6mm

341-936 12Fr., Charr. / Ø 4,0mm





LUER

Saugrohr zylindrisch, Arbeitslänge 90mm
Suction tube cylindrical, working length 90mm
Canula de aspiración cilíndrica, longitud de trabajo 90mm
Canule d'aspiration cylindrique, longueur de travail 90mm

433-451-10 Ø 1,0mm

433-451-15 Ø 1,5mm

433-451-20 Ø 2,0mm

Saugrohr zylindrisch, Arbeitslänge 110mm
Suction tube cylindrical, working length 110mm
Canula de aspiración cilíndrica, longitud de trabajo 110mm
Canule d'aspiration cylindrique, longueur de travail 110mm

433-453-30 Ø 3,0mm

433-453-40 Ø 4,0mm

433-453-50 Ø 5,0mm

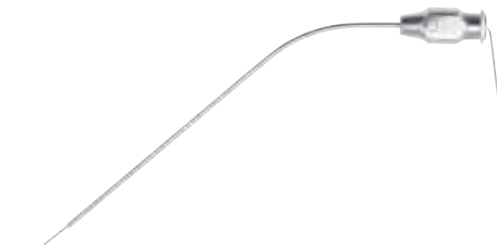

HOUSE

Saugkanüle kniegebogen, Luer-lock Arbeitslänge 70mm
Suction cannula, angled, luer lock, working length 70mm
Canula de aspiración, angulado, Luer-lock, longitud de trabajo 70mm
Canule d'aspiration, coudée, Luer-lock, longueur de travail 70mm

433-405-06 Ø 0,6mm

433-405-08 Ø 0,8mm

433-405-10 Ø 1,0mm

433-405-12 Ø 1,2mm

433-405-15 Ø 1,5mm

433-405-18 Ø 1,8mm

433-405-20 Ø 2,0mm

433-405-25 Ø 2,5mm

433-405-30 Ø 3,0mm



WULLSTEIN

Saughandgriff mit Unterbrecher, Luer-Konus, Gesamtlänge 110mm
Suction handle with suction control, luer-cone, total length 110mm
Mango de aspiración con válvula, cono Luer, longitud total 110mm
Manche d'aspiration avec soupape, cône Luer, longueur totale 110mm

433-500



HOUSE

Saughandgriff mit Unterbrecher, Luer-Konus, Gesamtlänge 65mm
Suction handle with suction control, luer-cone, total length 65mm
Mango de aspiración con válvula, cono Luer, longitud total 65mm
Manche d'aspiration avec soupape, cône Luer, longueur totale 65mm

433-504

WULLSTEIN

Saugrohr zylindrisch, Arbeitslänge 140mm
Suction tube cylindrical, working length 140mm
Canula de aspiración cilíndrica, longitud de trabajo 140mm
Canule d'aspiration cylindrique, longueur de travail 140mm

- 433-521 Ø 1,5mm
433-522 Ø 2,0mm



FISCH

Saugrohr, Arbeitslänge 90mm
Suction tube, working length 90mm
Canula de aspiración, longitud de trabajo 90mm
Canule d'aspiration, longueur de travail 90mm

- 433-601 Ø 1,2mm
433-602 Ø 1,5mm
433-603 Ø 2,0mm
433-604 Ø 2,2mm
433-605 Ø 3,0mm



BARNES

Saugrohr mit Unterbrecher, Arbeitslänge 50mm
Suction tube with suction control, working length 50mm
Canula de aspiración con válvula, longitud de trabajo 50mm
Canule d'aspiration avec soupape, longueur de travail 50mm

- 433-612 Ø 1,5mm
433-613 Ø 1,7mm
433-614 Ø 2,0mm



BARON

Saugrohr mit Unterbrecher, Arbeitslänge 75mm
Suction tube with suction control, working length 75mm
Canula de aspiración con válvula, longitud de trabajo 75mm
Canule d'aspiration avec soupape, longueur de travail 75mm

- 433-620 3 Fr./Charr. / Ø 1,0mm
433-622 5 Fr./Charr. / Ø 1,6mm
433-624 7 Fr./Charr. / Ø 2,3mm



HOUSE

Saug- und Spülrohr mit Unterbrecher, Arbeitslänge 90mm
Suction and irrigation tube with suction control, working length 90mm
Canula de aspiración y irrigación con valvula, longitud de trabajo 90mm
Canule d'aspiration et irrigation avec soupape longueur de travail 90mm

- 433-639 Ø 0,9 x 0,7mm
433-640 Ø 1,2 x 0,9mm
433-641 Ø 1,5 x 1,2mm
433-642 Ø 1,8 x 1,8mm
433-643 Ø 2,5 x 2,0mm
433-644 Ø 3,0 x 2,0mm
433-645 Ø 4,5 x 2,0mm





SCHUHKNECHT

Saugrohr mit Unterbrecher, Arbeitslänge 75mm
Suction tube with suction control, working length 75mm
Canula de aspiración con válvula, longitud de trabajo 75mm
Canule d'aspiration avec soupape, longueur de travail 75mm

433-666 24SWG / Ø 0,5mm

433-667 22SWG / Ø 0,7mm

433-668 20SWG / Ø 0,9mm



ZOELLNER

Saugrohr ohne Unterbrecher, Ø 2,5mm, Gesamtlänge 150mm
Suction tube without suction control, Ø 2,5mm, total length 150mm
Canula de aspiración sin válvula, Ø 2,5mm, longitud total 150mm
Canule d'aspiration sans soupape, Ø 2,5mm longueur totale 150mm

433-679

Saugrohr mit Unterbrecher, Ø 2,5mm, Gesamtlänge 150mm
Suction tube with suction control, Ø 2,5mm, total length 150mm
Canula de aspiración con válvula, Ø 2,5mm, longitud total 150mm
Canule d'aspiration avec soupape, Ø 2,5mm longueur totale 150mm



433-681

ZOELLNER

Aufsatz alleine
Tip only
Inserto solo
Embout seul



433-681-05 Ø 0,5mm

433-681-07 Ø 0,7mm

433-681-09 Ø 0,9mm

433-681-12 Ø 1,2mm

VERHOEVEN

Saugrohr Ø1,5mm, Arbeitslänge 90mm
Suction tube Ø1,5mm, working length 90mm
Canula de aspiración Ø1,5mm, longitud de trabajo 90mm
Canule d'aspiration Ø1,5mm, longueur de travail 90mm

433-730-15 gerade /straight / recta / droite

433-731-15 aufwärts gebogen / curved up

curvado hacia arriba / courbée vers le haut

433-732-15 abwärts gebogen / curved down

curvado hacia abajo / courbée vers le bas

Saugrohr Ø2,0mm, Arbeitslänge 90mm

Suction tube Ø2,0mm, working length 90mm

Canula de aspiración Ø2,0mm, longitud de trabajo 90mm

Canule d'aspiration Ø2,0mm, longueur de travail 90mm

433-730-20 gerade /straight / recta / droite

433-731-20 aufwärts gebogen / curved up

curvado hacia arriba / courbée vers le haut

433-732-20 abwärts gebogen / curved down

curvado hacia abajo / courbée vers le bas

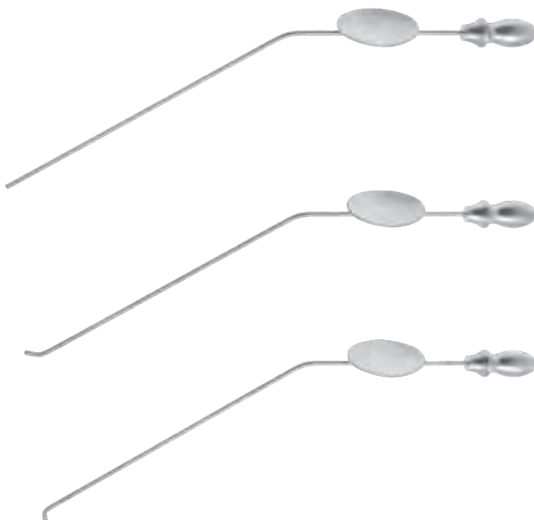

HOUSE

Scharfer Löffel, gebogen, Gesamtlänge 170mm
Curette, curved, total length 170mm
Cureta, curvado, longitud total 170mm
Curette, courbée, longueur totale 170mm

431-480-01	rund / round / redonda / ronde	Ø1,0mm / Ø1,2mm
431-481-01	oval / oval / oval / ovale	0,8x1,0mm / 1,0x1,2mm
431-481-02	oval / oval / oval / ovale	1,1x1,5mm / 1,3x1,8mm
431-481-03	oval / oval / oval / ovale	1,5x2,2mm / 1,9x2,6mm
431-481-04	oval / oval / oval / ovale	2,3x3,1mm / 2,5x3,3mm

Scharfer Löffel, gerade, Gesamtlänge 170mm
Curette, straight, total length 170mm
Cureta, recta, longitud total 170mm
Curette, droite, longueur totale 170mm

431-482-01	rund / round / redonda / ronde	Ø1,0mm / Ø1,2mm
-------------------	--------------------------------	-----------------

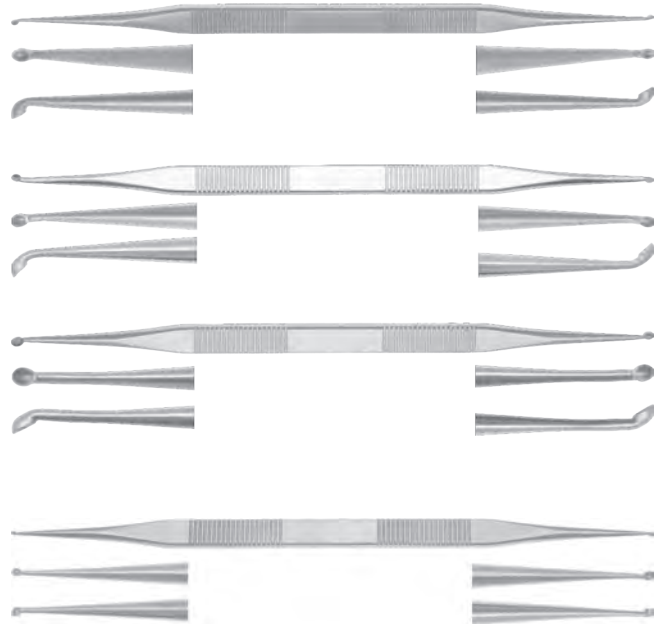

LEMPERT

Scharfer Löffel, oval, Gesamtlänge 205mm
Mastoid curette, ovale, total length 205mm
Cureta, oval, longitud total 205mm
Curette, ovale, longueur totale 205mm

431-499	Fig. 000000
431-500	Fig. 00000
431-501	Fig. 0000
431-502	Fig. 000
431-503	Fig. 00
431-504	Fig. 0
431-505	Fig. 1





WULLSTEIN

Raspatorium, Gesamtlänge 160mm
Raspatory, total length 160mm
Periostomo, longitud total 160mm
Rugine, longueur totale 160mm

- 431-519-01** gerade, Breite 2,2mm / straight, width 2,2mm
recto, anchura 2,2mm / droite, largeur 2,2mm
431-519-02 gebogen, Breite 3,2mm / curved, width 3,2mm
curvado, anchura 3,2mm / courbée, largeur 3,2mm



SHAMBOUGH-DERLACKI

Raspatorium leicht gebogen, Gesamtlänge 165mm
Raspatory, slightly curved, total length 165mm
Periostomo, ligeramente curvado, longitud total 165mm
Rugine, courbure légère, longueur totale 165mm

- 431-533** Breite 3,0mm / width 3,0mm
anchura 3,0mm / largeur 3,0mm



LEMPERT

Raspatorium gerade, Gesamtlänge 160mm
Raspatory, straight, total length 160mm
Periostomo, recto, longitud total 160mm
Rugine, droite, longueur totale 160mm

- 431-535** Breite 3,0mm / width 3,0mm
anchura 3,0mm / largeur 3,0mm



LEMPERT

Raspatorium gerade, Gesamtlänge 205mm
Raspatory, straight, total length 205mm
Periostomo, recto, longitud total 205mm
Rugine, droite, longueur totale 205mm

- 431-515** Breite 6,0mm / width 6,0mm
anchura 6,0mm / largeur 6,0mm

BARBARA (WULLSTEIN)

Nadel, gerade, Gesamtlänge 160mm
Needle, straight, total length 160mm
Aguja recta, longitud total 160mm
Pointe, droite, longueur totale 160mm

433-800 spitz, sharp, aguda, pointue
433-801 stumpf, blunt, roma, mousse

Nadel, gerade, lange Biegung, Gesamtlänge 160mm
Needle, straight, curved long, total length 160mm
Aguja recta, curva larga, longitud total 160mm
Pointe, droite, courbure longue, longueur totale 160mm

433-810 spitz, sharp, aguda, pointue
433-811 stumpf, blunt, roma, mousse

ROSEN

Nadel, gerade, kurze Biegung, Gesamtlänge 160mm
Needle, straight, curved short, total length 160mm
Aguja recta, curva corta, longitud total 160mm
Pointe, droite, courbure courte, longueur totale 160mm

433-812 spitz, sharp, aguda, pointue
433-813 stumpf, blunt, roma, mousse

Nadel, gerade, sehr leicht gebogen, Gesamtlänge 160mm
Needle, straight, very slightly curved, total length 160mm
Aguja recta, con curva muy ligera, longitud total 160mm
Pointe, droite, courbure très légère, longueur totale 160mm

433-814 spitz, sharp, aguda, pointue
433-815 stumpf, blunt, roma, mousse

SHAMBAUGH

Mikro Häkchen, gerade, Spitze 25° abgewinkelt, Gesamtlänge 160mm
Micro hook, straight, tip 25° angled, total length 160mm
Micro gancho, recto, punta 25° angulada, longitud total 160mm
Micro crochet, droit, pointe coudée 25°, longueur totale 160mm

433-820-03 0,3mm
433-820-06 0,6mm
433-820-10 1,0mm

SHAMBAUGH

Mikro Häkchen, gerade, Spitze 45° abgewinkelt, Gesamtlänge 160mm
Micro hook, straight, tip 45° angled, total length 160mm
Micro gancho, recto, punta 45° angulada, longitud total 160mm
Micro crochet, droit, pointe coudée 45°, longueur totale 160mm

433-825-02 0,2mm
433-825-03 0,3mm
433-825-04 0,4mm
433-825-06 0,6mm
433-825-08 0,8mm
433-825-10 1,0mm
433-825-12 1,2mm
433-825-15 1,5mm
433-825-20 2,0mm
433-825-25 2,5mm

SHAMBAUGH

Mikro Häkchen, gerade, Spitze 90° abgewinkelt, Gesamtlänge 160mm
Micro hook, straight, tip 90° angled, total length 160mm
Micro gancho, recto, punta 90° angulada, longitud total 160mm
Micro crochet, droit, pointe coudée 90°, longueur totale 160mm

433-830-02 0,2mm
433-830-03 0,3mm
433-830-04 0,4mm
433-830-06 0,6mm
433-830-08 0,8mm
433-830-10 1,0mm
433-830-12 1,2mm
433-830-15 1,5mm
433-830-20 2,0mm
433-830-25 2,5mm





SCHUHKNECHT

Nadel, kniegebogen, Gesamtlänge 160mm
Needle, angled, total length 160mm
Aguja, angulada, longitud total 160mm
Pointe, coudée, longueur totale 160mm

433-840 spitz, sharp, aguda, pointue
433-841 stumpf, blunt, roma, mousse

Mikro Häkchen, kniegebogen, Spitze 25° aufwärts abgewinkelt,
Gesamtlänge 160mm

Micro hook, angled, tip 25° angled up, total length 160mm
Micro gancho, angulado, punta 25° angulada hacia arriba,
longitud total 160mm

Micro crochet, coudé, pointe coudée 25° vers le haut, longueur totale 160mm

433-850-03 0,3mm
433-850-06 0,6mm
433-850-10 1,0mm



Mikro Häkchen, kniegebogen, Spitze 25° abwärts abgewinkelt,
Gesamtlänge 160mm

Micro hook, angled, tip 25° angled down, total length 160mm
Micro gancho, angulado, punta 25° angulada hacia abajo,
longitud total 160mm

Micro crochet, coudé, pointe coudée 25° vers le bas, longueur totale 160mm

433-855-03 0,3mm
433-855-06 0,6mm
433-855-10 1,0mm



Mikro Häkchen, kniegebogen, Spitze 45° aufwärts abgewinkelt,
Gesamtlänge 160mm

Micro hook, angled, tip 45° angled up, total length 160mm
Micro gancho, angulado, punta 45° angulada hacia arriba,
longitud total 160mm

Micro crochet, coudé, pointe coudée 45° vers le haut, longueur totale 160mm

433-860-03 0,3mm
433-860-06 0,6mm
433-860-10 1,0mm



Mikro Häkchen, kniegebogen, Spitze 45° abwärts abgewinkelt,
Gesamtlänge 160mm

Micro hook, angled, tip 45° angled down, total length 160mm
Micro gancho, angulado, punta 45° angulada hacia abajo,
longitud total 160mm

Micro crochet, coudé, pointe coudée 45° vers le bas, longueur totale 160mm

433-865-03 0,3mm
433-865-06 0,6mm
433-865-10 1,0mm



Mikro Häkchen, kniegebogen, Spitze 90° aufwärts abgewinkelt,
Gesamtlänge 160mm

Micro hook, angled, tip 90° angled up, total length 160mm
Micro gancho, angulado, punta 90° angulada hacia arriba,
longitud total 160mm

Micro crochet, coudé, pointe coudée 90° vers le haut, longueur totale 160mm

433-870-02 0,2mm
433-870-03 0,3mm
433-870-06 0,6mm
433-870-10 1,0mm



Mikro Häkchen, kniegebogen, Spitze 90° abwärts abgewinkelt,
Gesamtlänge 160mm

Micro hook, angled, tip 90° angled down, total length 160mm
Micro gancho, angulado, punta 90° angulada hacia abajo,
longitud total 160mm

Micro crochet, coudé, pointe coudée 90° vers le bas, longueur totale 160mm

433-875-02 0,2mm
433-875-03 0,3mm
433-875-06 0,6mm
433-875-10 1,0mm



ROSEN

Lanzettenmesser, Gesamtlänge 160mm
 Lancet knife, total length 160mm
 Cuchillo de lanceta, longitud total 160mm
 Bistouri lancéolé, longueur totale 160mm

433-899 abgewinkelt / angled / angulado / coudé



ROSEN

Rundschnittmesser, gerade Gesamtlänge 160mm
 Round knife, straight, total length 160mm
 Cuchillo redondo, recta, longitud total 160mm
 Bistouri rond, droit, longueur totale 160mm

- 433-900-10** Ø 1,0mm
- 433-900-15** Ø 1,5mm
- 433-900-18** Ø 1,8mm
- 433-900-20** Ø 2,0mm
- 433-900-23** Ø 2,3mm
- 433-900-25** Ø 2,5mm



Rundschnittmesser, 45° abgewinkelt, Gesamtlänge 160mm
 Round knife, 45° angled, total length 160mm
 Cuchillo redondo, 45° angulado, longitud total 160mm
 Bistouri rond, coudé 45°, longueur totale 160mm

- 433-901-10** Ø 1,0mm
- 433-901-14** Ø 1,4mm
- 433-901-16** Ø 1,6mm
- 433-901-20** Ø 2,0mm
- 433-901-23** Ø 2,3mm
- 433-901-26** Ø 2,6mm
- 433-901-28** Ø 2,8mm
- 433-901-30** Ø 3,0mm



Rundschnittmesser, 90° abgewinkelt, Gesamtlänge 160mm
 Round knife, 90° angled, total length 160mm
 Cuchillo redondo, 90° angulado, longitud total 160mm
 Bistouri rond, coudé 90°, longueur totale 160mm

- 433-903-15** Ø 1,5mm
- 433-903-20** Ø 2,0mm
- 433-903-25** Ø 2,5mm
- 433-903-30** Ø 3,0mm



PLESTER

Inzisions-, Lappenmesser, Gesamtlänge 160mm
 Incision-, flapknife, total length 160mm
 Cuchillo de incisión, longitud total 160mm
 Bistouri d'incision, longueur totale 160mm

- 433-906-30** 3,0x2,4mm
- 433-906-35** 3,5x2,4mm



PLESTER

Sichelmesser, Gesamtlänge 160mm
 Sickle knife, total length 160mm
 Cuchillo de forma hoz, longitud total 160mm
 Faux tige, longueur totale 160mm

- 433-908-01** gebogen / curved / curva / courbée
- 433-908-03** gebogen, sehr fein / curved, very fine
 curva, muy fino / courbée, très fine
- 433-908-04** gebogen, zweischneidig / curved, double cutting
 curva, de doble filo / courbée, à double tranchant

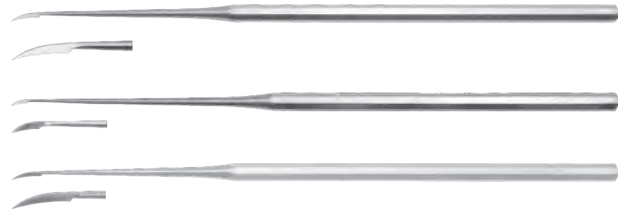

WULLSTEIN

Sichelmesser, Gesamtlänge 160mm
 Sickle knife, total length 160mm
 Cuchillo de forma hoz, longitud total 160mm
 Faux tige, longueur totale 160mm

- 433-908-05** gerade / straight / recta / droite



FISCH

Sichelmesser, Gesamtlänge 160mm
 Sickle knife, total length 160mm
 Cuchillo de forma hoz, longitud total 160mm
 Faux tige, longueur totale 160mm

- 433-907-10**





Raspatorium, leicht gebogen, Gesamtlänge 160mm
Raspatory, slightly curved, total length 160mm
Periostomo, ligeramente curvado, longitud total 160mm
Rugine, courbure légère, longueur totale 160mm

433-910 Breite 1,8mm / width 1,8mm
anchura 1,8mm / largeur 1,8mm



ROSEN

Raspatorium, abgewinkelt, Gesamtlänge 160mm
Raspatory, angled, total length 160mm
Periostomo, angulado, longitud total 160mm
Rugine, coudeé, longueur totale 160mm

433-913 Breite 1,0mm / width 1,0mm
anchura 1,0mm / largeur 1,0mm



ROSEN

Raspatorium, leicht gebogen, Gesamtlänge 160mm
Raspatory, slightly curved, total length 160mm
Periostomo, ligeramente curvado, longitud total 160mm
Rugine, courbure légère, longueur totale 160mm

433-914 Breite 1,0mm, gerades Arbeitsende
width 1,0mm, straight tip
anchura 1,0mm, punta recta
largeur 1,0mm, bout de travail droit



ROSEN

Raspatorium, leicht gebogen, Gesamtlänge 160mm
Raspatory, slightly curved, total length 160mm
Periostomo, ligeramente curvado, longitud total 160mm
Rugine, courbure légère, longueur totale 160mm

433-915 Breite 1,2mm, abgerundetes Arbeitsende
width 1,2mm, rounded tip
anchura 1,2mm, punta redondeada
largeur 1,2mm, bout de travail arrondi



ROSEN

Raspatorium, stark gebogen, Gesamtlänge 160mm
Raspatory, strongly curved, total length 160mm
Periostomo, fuerte curvado, longitud total 160mm
Rugine, courbure forte, longueur totale 160mm

433-916 Breite 1,8mm / width 1,8mm
anchura 1,8mm / largeur 1,8mm



ROSEN

Scharfer Löffel, leicht gebogen, Gesamtlänge 160mm
Curette, slightly curved, total length 160mm
Cureta, ligeramente curvado, longitud total 160mm
Curette, courbure légère, longueur totale 160mm

433-917 Breite 1,7mm / width 1,7mm
anchura 1,7mm / largeur 1,7mm



Transplantat-Träger und Raspatorium, Gesamtlänge 160mm
Graft holder and raspatory, total length 160mm
Porta-injerto y periostomo, longitud total 160mm
Porte-transplant et rugine, longueur totale 160mm

433-920 leicht abgewinkelt 6,0x2,0mm
slightly angled 6,0x2,0mm
ligeramente angulado 6,0x2,0mm
légèrement coudeé 6,0x2,0mm

ROSEN

Fenestrierhäkchen, gerade, retrograd schneidend, Gesamtlänge 160mm
 Fenestra hook, straight, retrograde cutting, total length 160mm
 Gancho para fenestrar, recto, cortante retrogrado, longitud total 160mm
 Crochet bistouri, droit, coupe rétrograde, longueur totale 160mm

433-918 0,6mm



FISCH

Dissektor, doppelt gebogen, Breite 1,0mm, Gesamtlänge 160mm
 Dissector, double curved, width 1,0mm, total length 160mm
 Dissector, doble curvado, anchura 1,0mm, longitud total 160mm
 Dissecteur, courbure double, largeur 1,0mm, longueur totale 160mm

433-935L nach links / to the left / izquierda / à gauche
433-935R nach rechts / to the right / derecha / à droite



FISCH

Dissektor, einfach gebogen, Breite 1mm, Gesamtlänge 160mm
 Dissector, single curved, width 1mm, total length 160mm
 Dissector, curva sola, anchura 1,0mm, longitud total 160mm
 Dissecteur, courbure simple, largeur 1,0mm, longueur totale 160mm

433-937L nach links / to the left / izquierda / à gauche
433-937R nach rechts / to the right / derecha / à droite



FISCH

Perforator, Gesamtlänge 160mm
 Perforator, total length 160mm
 Perforador, longitud total 160mm
 Perforateur, longueur totale 160mm

433-940-03 Ø 0,3mm
433-940-04 Ø 0,4mm
433-940-05 Ø 0,5mm
433-940-06 Ø 0,6mm



PLESTER

Häkchen, 2,0mm retrograd gebogen, Gesamtlänge 160mm
 Hook 2,0mm retrograde curved, total length 160mm
 Gancho, 2,0 mm retrógrado, curvado, longitud total 160mm
 Crochet, 2,0mm courbé rétrograde, longueur totale 160mm

433-833



PLESTER

Schaber, 60° rückwärts gewinkelt, Gesamtlänge 160mm
 Scraper, angled 60° backwards, total length 160mm
 Raspador, angulado 60° hacia atrás, longitud total 160mm
 Rugine, coudée 60° vers l'arrière, longueur totale 160mm

433-960 Breite 2,0mm / width 2,0mm
 anchura 2,0mm / largeur 2,0mm



PLESTER

Fußplattenhäkchen, 90° abgewinkelt, Gesamtlänge 160mm
 Footplate hook, angled 90°, total length 160mm
 Gancho reposapiés, angulado 90°, longitud total 160mm
 Crochet pour la platine de l'étrier, longueur totale 160mm

433-962-02 0,2mm
433-962-04 0,4mm
433-962-06 0,6mm



PLESTER

Antrum Häkchen, Gesamtlänge 160mm
 Antrum hook, total length 160mm
 Gancho antro, longitud total 160mm
 Crochet antre, longueur totale 160mm

433-970 90° zylindrisch / 90° cylindrical
 90° cilíndrico / 90° cylindrique
433-971 45° geknöpft / 45° button ended
 45° punta botón / pointe bouton

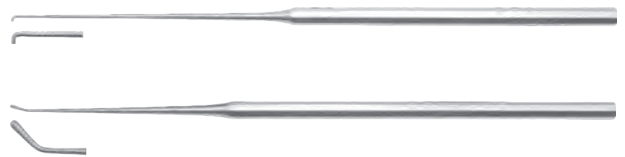



PLESTER

Einführungsgabel für Stapes-Prothesen, Gesamtlänge 160mm
Prothesis introducer, total length 160mm
Introductor prótesis, longitud total 160mm
Introduceur prothèse, longueur totale 160mm

433-978



FISCH

Messzylinder, kniegebogen, Gesamtlänge 160mm
Caliper, angled, total length 160mm
Aparato de medición, angulado, longitud total 160mm
Mesureur cylindrique, coudé, longueur totale 160mm

433-994-04 Ø 0,4mm

433-994-06 Ø 0,6mm



FISCH

Messzylinder, Gesamtlänge 160mm
Caliper, total length 160mm
Aparato de medición, longitud total 160mm
Mesureur cylindrique, longueur totale 160mm

433-995-04 Ø 0,4mm

433-995-06 Ø 0,6mm

433-995-08 Ø 0,8mm



HOUSE

Tiefenmesssonde, Gesamtlänge 160mm
Measuring rod (caliper), total length 160mm
Aparato de medición de profundidad, longitud total 160mm
Mesureur de profondeur, longueur totale 160mm

433-996-35 Markierung bei 3,5mm / marker pin at 3,5mm
punta de marcación 3,5mm / pointe de repère à 3,5mm

433-996-40 Markierung bei 4,0mm / marker pin at 4,0mm
punta de marcación 4,0mm / pointe de repère à 4,0mm

433-996-45 Markierung bei 4,5mm / marker pin at 4,5mm
punta de marcación 4,5mm / pointe de repère à 4,5mm

433-996-50 Markierung bei 5,0mm / marker pin at 5,0mm
punta de marcación 5,0mm / pointe de repère à 5,0mm

Mikro Ohrzängchen, Maulteil 0,6x4mm gerieft, Arbeitslänge 80mm
Micro ear forceps, jaws 0,6x4mm serrated, working length 80mm
Micro pinza auricular, boca 0,6x4mm estriada, longitud de trabajo 80mm
Micro pince auriculaire, mors 0,6x4mm strié, longueur de travail 80mm

- 432-052** gerade / straight / recta / droit
- 432-053** aufgebogen / curved up / curva por arriba / courbé vers le haut
- 432-055** rechts gebogen / curved right / curva derecha / courbé droite
- 432-057** links gebogen / curved left / curva izquierda / courbé gauche



Mikro Ohrzängchen, Maulteil 0,8x4mm gerieft, Arbeitslänge 80mm
Micro ear forceps, jaws 0,8x4mm serrated, working length 80mm
Micro pinza auricular, boca 0,8x4mm estriada, longitud de trabajo 80mm
Micro pince auriculaire, mors 0,8x4mm strié, longueur de travail 80mm

- 432-062** gerade / straight / recta / droit
- 432-063** aufgebogen / curved up / curva por arriba / courbé vers le haut
- 432-065** rechts gebogen / curved right / curva derecha / courbé droite
- 432-067** links gebogen / curved left / curva izquierda / courbé gauche



FISCH

Mikro Ohrzängchen, Maulteil 0,7x3,5mm gerieft, Arbeitslänge 80mm
Micro ear forceps, jaws 0,7x3,5mm serrated, working length 80mm
Micro pinza auricular, boca 0,7x3,5mm estriada, longitud de trabajo 80mm
Micro pince auriculaire, mors 0,7x3,5mm strié, longueur de travail 80mm

- 432-022** gerade / straight / recta / droit



Mikro Ohrzängchen, gerade, glatt, Arbeitslänge 80mm
Micro ear forceps, straight, smooth, working length 80mm
Micro pinza auricular, recta, lisa, longitud de trabajo 80mm
Micro pince auriculaire, droit, lisse, longueur de travail 80mm

- 432-030** 0,8x6mm
- 432-050** 0,6x4mm
- 432-060** 0,8x4mm





SHEA-BELLUCCI

Mikro Ohrscherchen, Schneidblätter 7mm, Arbeitslänge 80mm
Micro ear scissors, blades 7mm, working length 80mm
Micro tijera auricular, hojas 7mm, longitud de trabajo 80mm
Micro ciseaux auriculaires, lames 7mm, longueur de travail 80mm

- 432-300** gerade / straight / recta / droit
432-303 rechts gebogen / curved right / curva derecha / courbé droite
432-305 links gebogen / curved left / curva izquierda / courbé gauche



BELLUCCI

Mikro Ohrscherchen, sehr fein, Schneidblätter 3mm, Arbeitslänge 80mm
Micro ear scissors, very delicate, blades 3mm, working length 80mm
Micro tijera auricular, muy fina, hojas 3mm, longitud de trabajo 80mm
Micro ciseaux auriculaires, très fin, lames 3mm, longueur de travail 80mm

- 432-320** gerade / straight / recta / droit



BELLUCCI

Mikro Ohrscherchen, fein, Schneidblätter 5mm, Arbeitslänge 80mm
Micro ear scissors, delicate, blades 5mm, working length 80mm
Micro tijera auricular, fina, hojas 5mm, longitud de trabajo 80mm
Micro ciseaux auriculaires, fin, lames 5mm, longueur de travail 80mm

- 432-340** gerade / straight / recta / droit
432-341 rechts gebogen / curved right / curva derecha / courbé droite
432-343 links gebogen / curved left / curva izquierda / courbé gauche
432-345 aufgebogen / curved up / curva por arriba / courbé vers le haut



FISCH-BELLUCCI

Mikro Ohrscherchen, extrem fein, Schneidblätter 2mm, Arbeitslänge 80mm
Micro ear scissors, extreme delicate, blades 2mm, working length 80mm
Micro tijera auricular, extra fina, hojas 2mm, longitud de trabajo 80mm
Micro ciseaux auriculaires, extra fin, lames 2mm, longueur de travail 80mm

- 432-360** gerade / straight / recta / droit



FISCH

Crurotomie Scherchen, Schneidblätter 2mm, Arbeitslänge 80mm
Crurotomy scissors, blades 2mm, working length 80mm
Tijeras de crurotomía, hojas 2mm, longitud de trabajo 80mm
Ciseaux de crurotomies, lames 2mm, longueur de travail 80mm

- 432-381** nach rechts öffnend / opening to the right side /
apertura a la derecha / ouverant vers la droite
432-383 nach links öffnend / opening to the left side /
apertura a la izquierda / ouverant vers la gauche

Mikro Ohrzängchen, ovaler Löffel 0,9x1,8mm, Arbeitslänge 80mm
Micro ear forceps, oval cups 0,9x1,8mm, working length 80mm
Micro pinza auricular, cuchara ovalada 0,9x1,8mm, longitud de trabajo 80mm
Micro pince auriculaire, cuillère ovale 0,9x1,8mm, longueur de travail 80mm

- 432-530** gerade / straight / recta / droit
432-531 rechts gebogen / curved right / curva derecha / courbé droite
432-533 links gebogen / curved left / curva izquierda / courbé gauche
432-535 aufgebogen / curved up / curva por arriba / courbé vers le haut



Mikro Ohrzängchen, ovaler Löffel 0,6x1,8mm, Arbeitslänge 80mm
Micro ear forceps, oval cups 0,6x1,8mm, working length 80mm
Micro pinza auricular, cuchara ovalada 0,6x1,8mm, longitud de trabajo 80mm
Micro pince auriculaire, cuillère ovale 0,6x1,8mm, longueur de travail 80mm

- 432-580** gerade / straight / recta / droit
432-581 rechts gebogen / curved right / curva derecha / courbé droite
432-583 links gebogen / curved left / curva izquierda / courbé gauche
432-585 aufgebogen / curved up / curva por arriba / courbé vers le haut





DIETER

Hammerkopfstanze, Arbeitslänge 80mm
Malleus nipper, working length 80mm
Punzadora cabezal martillo, longitud de trabajo 80mm
Pince guillotine, longueur de travail 80mm

- 432-720** aufwärts schneidend / upwards biting /
cortante hacia arriba / coupant vers le haut
- 432-722** rechts schneidend / right biting /
cortante a la derecha / coupant à droite
- 432-723** links schneidend / left biting /
cortante a la izquierda / coupant à gauche
- 432-725** abwärts schneidend / downwards cutting /
cortante hacia abajo / coupant vers le bas



GREVEN

Drahtschließzängchen, gerade, Arbeitslänge 80mm
Wire crimper forceps, straight, working length 80mm
Pinza para arrugar alambre, recta, longitud de trabajo 80mm
Pince à serrer les fils, droit, longueur de travail 80mm

- 432-760** Maulteil 0,8x6mm / jaws 0,8x6mm
boca 0,8x6mm / mors 0,8x6mm



McGEE

Drahtschließzängchen, abwärts, Arbeitslänge 80mm
Wire crimper forceps, downwards, working length 80mm
Pinza para arrugar alambre, hacia abajo, longitud de trabajo 80mm
Pince à serrer les fils, vers le bas, longueur de travail 80mm

- 432-770** Maulteil 0,8x5mm / jaws 0,8x5mm
boca 0,8x5mm / mors 0,8x5mm



FISCH-McGEE

Drahtschließzängchen, abwärts, Arbeitslänge 80mm
Wire crimper forceps, downwards, working length 80mm
Pinza para arrugar alambre, hacia abajo, longitud de trabajo 80mm
Pince à serrer les fils, vers le bas, longueur de travail 80mm

- 432-776** Maulteil 0,8x3,5mm / jaws 0,8x3,5mm
boca 0,8x3,5mm / mors 0,8x3,5mm



FULLER

Piston Einführzange Arbeitslänge 80mm
Piston introducing forceps, working length 80mm
Pinza para inserción de piston, longitud de trabajo 80mm
Pince à piston introducteur, longueur de travail 80mm

- 432-152** Maulteil 0,8x6,0mm / jaws 0,8x6,0mm
boca 0,8x6,0mm / mors 0,8x6,0mm



SCHUHKNECHT

Bieegerät für Stapes-Prothesen
Wire bending die for stapes protheses
Doblador para protesis stapes
Cintreuse pour prothèse stapes

432-780

TIECK-HALLE

Nasenspekulum, Gesamtlänge 130mm
Nasal speculum, total length 130mm
Especulo nasal, longitud total 130mm
Spéculum nasal, longueur totale 130mm

- 440-230** für Säuglinge / for babies
para neonatos / pour nouveau-nés
440-231 für Kleinkinder / for infants
para niños / pour petits enfants



TIECK-HALLE

Nasenspekulum, zerlegbar, Gesamtlänge 130mm
Nasal speculum, dismountable, total length 130mm
Especulo nasal, desmontable, longitud total 130mm
Spéculum nasal, démontable, longueur totale 130mm

- 440-230AS** für Säuglinge / for babies
para neonatos / pour nouveau-nés
440-231AS für Kleinkinder / for infants
para niños / pour petits enfants



BECKMANN

Nasenspekulum, seitwärts gebogen, Gesamtlänge 130mm
Nasal speculum, lateral curved, total length 130mm
Especulo nasal, curvado lateral, longitud total 130mm
Spéculum nasal, courbé latéralement, longueur totale 130mm

- 440-234** für Säuglinge / for babies
para neonatos / pour nouveau-nés



WIEN / VIENNA

Nasenspekulum, Gesamtlänge 130mm
Nasal speculum, total length 130mm
Especulo nasal, longitud total 130mm
Spéculum nasal, longueur totale 130mm

- 440-200** Blattlänge 27mm / blade length 27mm
longitud hoja 27mm/ longueur lame 27mm
440-201 Blattlänge 30mm / blade length 30mm
longitud hoja 30mm / longueur lame 30mm
440-202 Blattlänge 33mm / blade length 33mm
longitud hoja 33mm / longueur lame 33mm



HARTMANN

Nasenspekulum, Gesamtlänge 150mm
Nasal speculum, total length 150mm
Especulo nasal, longitud total 150mm
Spéculum nasal, longueur totale 150mm

- 440-210** Blattlänge 29mm / blade length 29mm
longitud hoja 29mm/ longueur lame 29mm
440-211 Blattlänge 33mm / blade length 33mm
longitud hoja 33mm / longueur lame 33mm
440-212 Blattlänge 37mm / blade length 37mm
longitud hoja 37mm / longueur lame 37mm



HARTMANN

Nasenspekulum, zerlegbar, Gesamtlänge 150mm
Nasal speculum, dismountable, total length 150mm
Especulo nasal, desmontable, longitud total 150mm
Spéculum nasal, démontable, longueur totale 150mm

- 440-210AS** Blattlänge 29mm / blade length 29mm
longitud hoja 29mm / longueur lame 29mm
440-211AS Blattlänge 33mm / blade length 33mm
longitud hoja 33mm / longueur lame 33mm
440-212AS Blattlänge 37mm / blade length 37mm
longitud hoja 37mm / longueur lame 37mm





HARTMANN-HALLE

Nasenspekulum, Gesamtlänge 150mm
Nasal speculum, total length 150mm
Especulo nasal, longitud total 150mm
Spéculum nasal, longueur totale 150mm

- 440-220** Blattlänge 29mm / blade length 29mm
longitud hoja 29mm / longueur lame 29mm
- 440-221** Blattlänge 33mm / blade length 33mm
longitud hoja 33mm / longueur lame 33mm
- 440-222** Blattlänge 37mm / blade length 37mm
longitud hoja 37mm / longueur lame 37mm



HARTMANN-HALLE

Nasenspekulum, zerlegbar, Gesamtlänge 150mm
Nasal speculum, dismountable, total length 150mm
Especulo nasal, desmontable, longitud total 150mm
Spéculum nasal, démontable, longueur totale 150mm

- 440-220AS** Blattlänge 29mm / blade length 29mm
longitud hoja 29mm / longueur lame 29mm
- 440-221AS** Blattlänge 33mm / blade length 33mm
longitud hoja 33mm / longueur lame 33mm
- 440-222AS** Blattlänge 37mm / blade length 37mm
longitud hoja 37mm / longueur lame 37mm



KILLIAN

Nasenspekulum, Gesamtlänge 140mm
Nasal speculum, total length 140mm
Especulo nasal, longitud total 140mm
Spéculum nasal longueur totale 140mm

- 440-250** Blattlänge 40mm / blade length 40mm
longitud hoja 40mm / longueur lame 40mm
- 440-251** Blattlänge 55mm / blade length 55mm
longitud hoja 55mm / longueur lame 55mm
- 440-254** Blattlänge 65mm / blade length 65mm
longitud hoja 65mm / longueur lame 65mm
- 440-252** Blattlänge 75mm / blade length 75mm
longitud hoja 75mm / longueur lame 75mm
- 440-253** Blattlänge 90mm / blade length 90mm
longitud hoja 90mm / longueur lame 90mm



KILLIAN

Nasenspekulum, zerlegbar, Gesamtlänge 140mm
Nasal speculum, dismountable, total length 140mm
Especulo nasal, desmontable, longitud total 140mm
Spéculum nasal, démontable, longueur totale 140mm

- 440-250AS** Blattlänge 40mm / blade length 40mm
longitud hoja 40mm / longueur lame 40mm
- 440-251AS** Blattlänge 55mm / blade length 55mm
longitud hoja 55mm / longueur lame 55mm
- 440-254AS** Blattlänge 65mm / blade length 65mm
longitud hoja 65mm / longueur lame 65mm
- 440-252AS** Blattlänge 75mm / blade length 75mm
longitud hoja 75mm / longueur lame 75mm
- 440-253AS** Blattlänge 90mm / blade length 90mm
longitud hoja 90mm / longueur lame 90mm

KILLIAN-STRUYCKEN

Nasenspekulum, zerlegbar, Gesamtlänge 140mm
Nasal speculum, dismountable, total length 140mm
Especulo nasal, desmontable longitud total 140mm
Spéculum nasal, démontable, longueur totale 140mm

- 440-264-40AS** Blattlänge 40mm / blade length 40mm
longitud hoja 40mm / longueur lame 40mm
- 440-264-55AS** Blattlänge 55mm / blade length 55mm
longitud hoja 55mm / longueur lame 55mm
- 440-264-75AS** Blattlänge 75mm / blade length 75mm
longitud hoja 75mm / longueur lame 75mm
- 440-264-90AS** Blattlänge 90mm / blade length 90mm
longitud hoja 90mm / longueur lame 90mm



COTTLE

Nasenspekulum, zerlegbar, Gesamtlänge 140mm
Nasal speculum, dismountable, total length 140mm
Especulo nasal, desmontable, longitud total 140mm
Spéculum nasal, démontable, longueur totale 140mm

- 440-270AS** Blattlänge 35mm / blade length 35mm
longitud hoja 35mm / longueur lame 35mm
- 440-271AS** Blattlänge 55mm / blade length 55mm
longitud hoja 55mm / longueur lame 55mm
- 440-272AS** Blattlänge 75mm / blade length 75mm
longitud hoja 75mm / longueur lame 75mm
- 440-273AS** Blattlänge 90mm / blade length 90mm
longitud hoja 90mm / longueur lame 90mm

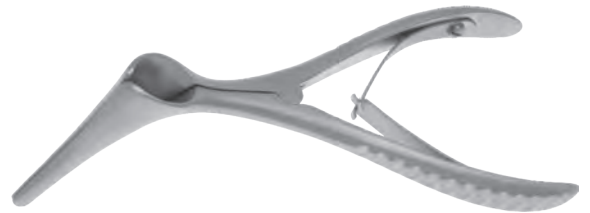

COTTLE

Nasenspekulum, mit Stellschraube, zerlegbar, Gesamtlänge 140mm
Nasal speculum, with set screw, dismountable, total length 140mm
Especulo nasal, con tornillo de ajuste, desmontable, longitud total 140mm
Spéculum nasal, avec vis de ajustage, démontable, long. totale 140mm

- 440-275AS** Blattlänge 35mm / blade length 35mm
longitud hoja 35mm / longueur lame 35mm
- 440-276AS** Blattlänge 55mm / blade length 55mm
longitud hoja 55mm / longueur lame 55mm
- 440-277AS** Blattlänge 75mm / blade length 75mm
longitud hoja 75mm / longueur lame 75mm
- 440-278AS** Blattlänge 90mm / blade length 90mm
longitud hoja 90mm / longueur lame 90mm





TILLEY

Nasentampon Zange, Gesamtlänge 165mm
Nasal dressing forceps, total length 165mm
Pinza de tamponaje, longitud total 165mm
Pince à tampons, longueur totale 165mm

441-502

Arbeitslänge 90mm
working length 90mm
longitud de trabajo 90mm
longueur de travail 90mm

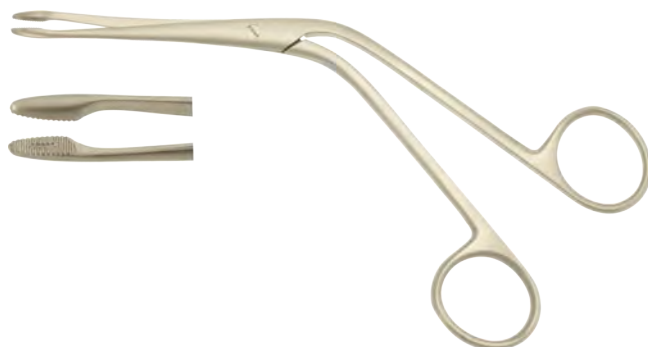

HARTMANN

Nasentampon Zange, schlank, Gesamtlänge 160mm
Nasal dressing forceps, slender, total length 160mm
Pinza de tamponaje, légère, longitud total 160mm
Pince à tampons, delgado, longueur totale 160mm

441-504

Arbeitslänge 80mm
working length 80mm
longitud de trabajo 80mm
longueur de travail 80mm



HARTMANN

Nasentampon Zange, Gesamtlänge 200mm
Nasal dressing forceps, total length 200mm
Pinza de tamponaje, longitud total 200mm
Pince à tampons, longueur totale 200mm

441-505

Arbeitslänge 110mm
working length 110mm
longitud de trabajo 110mm
longueur de travail 110mm

TROELTSCH

Anatomische Nasenpinzette, Gesamtlänge 150mm
Nasal dressing forceps, total length 150mm
Pinza nasal de disección, longitud total 150mm
Pince nasale à dissection, longueur totale 150mm

141-311 Arbeitslänge 85mm
working length 85mm
longitud de trabajo 85mm
longueur de travail 85mm



TROELTSCH

Anatomische Nasenpinzette, Gesamtlänge 180mm
Nasal dressing forceps, total length 180mm
Pinza nasal de disección, longitud total 180mm
Pince nasale à dissection, longueur totale 180mm

141-312 Arbeitslänge 110mm
working length 110mm
longitud de trabajo 110mm
longueur de travail 110mm



JANSEN

Anatomische Nasenpinzette, Gesamtlänge 165mm
Nasal dressing forceps, total length 165mm
Pinza nasal de disección, longitud total 165mm
Pince nasale à dissection, longueur totale 165mm

141-340 Arbeitslänge 70mm
working length 70mm
longitud de trabajo 70mm
longueur de travail 70mm



GRUENWALD

Anatomische Nasenpinzette, Gesamtlänge 200mm
Nasal dressing forceps, total length 200mm
Pinza nasal de disección, longitud total 200mm
Pince nasale à dissection, longueur totale 200mm

141-344 Arbeitslänge 100mm
working length 100mm
longitud de trabajo 100mm
longueur de travail 100mm





KRAUSE

Nasenpolypenschnürer 260mm
Nasal snare 260mm
Polipotomo 260mm
Serre noeuds 260mm

440-700



Schnürerdraht für Nasenpolypenschnürer, Packung à 12 Stück
Nasal snare wires, 1 dozen
Alambre para Polipotomo, paquete de 12 unidades
Anses de rechange pour serre noeuds, paquet de 12 pièces

440-760-30 Ø 0,30mm, 100mm

440-760-40 Ø 0,40mm, 100mm



Schnürerdraht für Nasenpolypenschnürer, Packung à 100 Stück
Nasal snare wires, 100 pieces
Alambre para Polipotomo, paquete de 100 unidades
Anses de rechange pour serre noeuds, paquet de 100 pièces

440-762-30 Ø 0,30mm, 100mm

440-762-35 Ø 0,35mm, 100mm

440-762-40 Ø 0,40mm, 100mm

COTTLE

Nasenschere, Arbeitslänge 85mm, Gesamtlänge 160mm
Nasal scissors, working length 85mm, total length 160mm
Tijera nasal, longitud de trabajo 85mm, longitud total 160mm
Ciseaux nasales, longueur de travail 85mm, longueur totale 160mm

125-101



FOMON

Nasenschere, Arbeitslänge 70mm, Gesamtlänge 140mm
Nasal scissors, working length 70mm, total length 140mm
Tijera nasal, longitud de trabajo 70mm, longitud total 140mm
Ciseaux nasales, longueur de travail 70mm, longueur totale 140mm

125-105

125-105Z beide Blätter gezahnt / both blades serrated
ambas hojas dentadas / les deux lames dentelées



HEYMANN

Nasenschere, Arbeitslänge 90mm, Gesamtlänge 175mm
Nasal scissors, working length 90mm, total length 175mm
Tijera nasal, longitud de trabajo 90mm, longitud total 175mm
Ciseaux nasales, longueur de travail 90mm, longueur totale 175mm

125-800



ELCON

Nasenschere, Arbeitslänge 90mm, Gesamtlänge 175mm
Nasal scissors, working length 90mm, total length 175mm
Tijera nasal, longitud de trabajo 90mm, longitud total 175mm
Ciseaux nasales, longueur de travail 90mm, longueur totale 175mm

125-813 beide Blätter gezahnt / both blades serrated
ambas hojas dentadas / les deux lames dentelées



Nasenschere, unteres Blatt gezahnt, Arbeitslänge 130mm
Nasal scissors, lower blade serrated, working length 130mm
Tijera nasal, hoja baja dentada, longitud de trabajo 130mm
Ciseaux nasales, lame inférieure dentelée, longueur de travail 130mm

441-550 gerade / straight / recta / droit

441-551 rechts gebogen / curved right
curva derecha / courbé droite

441-553 links gebogen / curved left
curva izquierda / courbé gauche

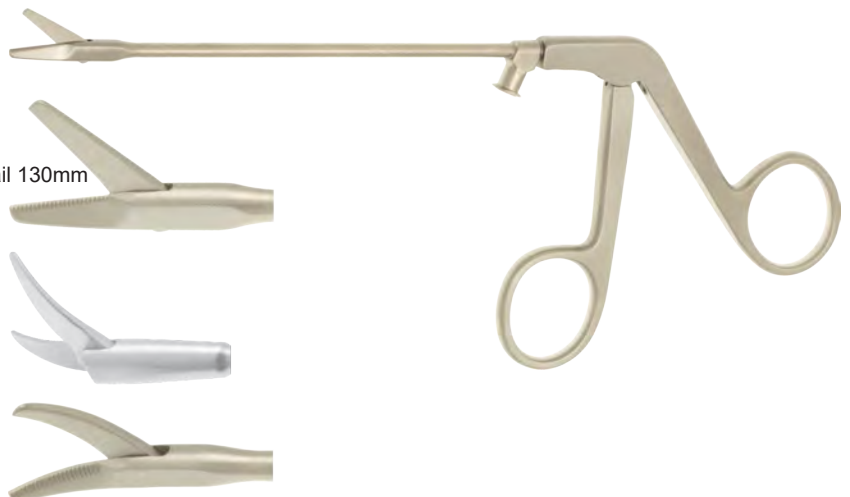



GRUENWALD-HENKE

Conchotom, durchschneidend, Arbeitslänge 110mm
Nasal cutting forceps, through-cutting, working length 110mm
Conchotomo, cortante, longitud de trabajo 110mm
Conchotome, tranchant, longueur de travail 110mm

441-600-01 3,0mm breit / 3,0mm wide
ancho 3,0mm / largeur 3,0mm

441-600-02 3,5mm breit / 3,5mm wide
ancho 3,5mm / largeur 3,5mm



HARTMANN

Conchotom, runder Schnitt, Arbeitslänge 110mm
Nasal cutting forceps, round cutting, working length 110mm
Conchotomo, corte circular, longitud de trabajo 110mm
Conchotome, coupe circulaire, longueur de travail 110mm

441-592-01 Ø 5mm

441-592-02 Ø 7mm

441-592-03 Ø 9mm

441-592-04 Ø 11mm



STRUYKEN

Conchotom, durchschneidend, Arbeitslänge 115mm
Conchotom, trough-cutting, working length 115mm
Conchotom, cortante, longitud de trabajo 115mm
Conchotome, tranchante, longueur de travail 115mm

441-624 1,0mm breit / 1,0mm wide
ancho 1,0mm / largeur 1,0mm

TAKAHASHI

Nasenzange, gerade, Arbeitslänge 110mm
Nasal forceps, straight, working length 110mm
Pinza nasal, recta, longitud de trabajo 110mm
Pince nasale, droite, longueur de travail 110mm

- 441-660-01** 2,5x10mm
- 441-660-02** 3,0x10mm
- 441-660-03** 4,0x10mm

Nasenzange, aufgebogen, Arbeitslänge 110mm
Nasal forceps, curved up, working length 110mm
Pinza nasal, curva hacia arriba, longitud de trabajo 110mm
Pince nasale, courbée vers le haut, longueur de travail 110mm

- 441-661-01** 2,5x10mm
- 441-661-02** 3,0x10mm
- 441-661-03** 4,0x10mm

WATSON-WILLIAMS

Nasenzange, gerade, Arbeitslänge 110mm
Nasal forceps, straight, working length 110mm
Pinza nasal, recta, longitud de trabajo 110mm
Pince nasale, droite, longueur de travail 110mm

- 441-668-01** 5,0mm breit / 5,0mm wide
ancho 5,0mm / largeur 5,0mm
- 441-668-02** 7,0mm breit / 7,0mm wide
ancho 7,0mm / largeur 7,0mm
- 441-668-03** 9,0mm breit / 9,0mm wide
ancho 9,0mm / largeur 9,0mm

WATSON-WILLIAMS

Nasenzange, gezahnter Löffel, Arbeitslänge 110mm
Nasal forceps, serrated cup, working length 110mm
Pinza nasal, cuchara dentada, longitud de trabajo 110mm
Pince nasale, cuillère dentelée, longueur de travail 110mm

- 441-696** gerade / straight / recta / droit

STRUEMPPEL-VOSS

Nasenzange, sehr fein, Arbeitslänge 110mm
Nasal forceps, extra delicate, working length 110mm
Pinza nasal, muy fina, longitud de trabajo 110mm
Pince nasale, extra fine, longueur de travail 110mm

- 441-689** 45° aufgebogen / 45° curved up
45° curva hacia arriba / 45° courbé vers le haut





BLAKESLEY

Nasenzange, gerade, Arbeitslänge 110mm
Nasal forceps, straight, working length 110mm
Pinza nasal, recta, longitud de trabajo 110mm
Pince nasale, droite, longueur de travail 110mm

441-650-25	2,5mm
441-650-30	3,0mm
441-650-36	3,5mm
441-650-42	4,0mm
441-650-48	5,0mm
441-650-58	6,3mm



BLAKESLEY

Nasenzange, 45° aufgebogen, Arbeitslänge 110mm
Nasal forceps, 45° curved up, working length 110mm
Pinza nasal, 45° curva hacia arriba, longitud de trabajo 110mm
Pince nasale, 45° courbée vers le haut, longueur de travail 110mm

441-655-25	2,5mm
441-655-30	3,0mm
441-655-36	3,5mm
441-655-42	4,0mm
441-655-48	5,0mm



BLAKESLEY

Nasenzange, 90° aufgebogen, Arbeitslänge 110mm
Nasal forceps, 90° curved up, working length 110mm
Pinza nasal, 90° curva hacia arriba, longitud de trabajo 110mm
Pince nasale, 90° courbée vers le haut, longueur de travail 110mm

441-675-30	3,0mm
441-675-36	3,5mm
441-675-42	4,0mm
441-675-48	5,0mm



BLAKESLEY

Nasenzange, durchschneidend, gerade, Arbeitslänge 110mm
Nasal forceps, through-cutting, straight, working length 110mm
Pinza nasal, cortante, recta, longitud de trabajo 110mm
Pince nasale, tranchante, droite, longueur de travail 110mm

441-690-25	2,5mm
441-690-35	3,5mm
441-690-42	4,0mm



BLAKESLEY

Nasenzange, durchschneidend 45° aufgebogen, Arbeitslänge 110mm
Nasal forceps, through-cutting, 45° curved up, working length 110mm
Pinza nasal, cortante, 45° curva hacia arriba, longitud de trabajo 110mm
Pince nasale, tranchante, 45° courbée vers le haut, longueur de travail 110mm

441-691-25	2,5mm
441-691-35	3,5mm
441-691-42	4,0mm

BLAKESLEY "e-move"

Nasenzange, zerlegbar, gerade, Arbeitslänge 110mm
Nasal forceps, detachable, straight, working length 110mm
Pinza nasal, decomposable, recta, longitud de trabajo 110mm
Pince nasale, desmontable, droite, longueur de travail 110mm

441-650-25DT 2,5mm
441-650-30DT 3,0mm
441-650-35DT 3,5mm
441-650-40DT 4,0mm
441-650-50DT 5,0mm
441-650-63DT 6,3mm

Nasenzange, zerlegbar, 45° aufgebogen, Arbeitslänge 110mm
Nasal forceps, detachable, 45° curved up, working length 110mm
Pinza nasal, decomposable, 45° curva hacia arriba, longitud de trabajo 110mm
Pince nasale, desmontable, 45° courbée vers le haut, decomposable, longueur de travail 110mm

441-655-30DT 3,0mm
441-655-35DT 3,5mm
441-655-40DT 4,0mm
441-655-50DT 5,0mm

Nasenzange, zerlegbar, 90° aufgebogen, Arbeitslänge 110mm
Nasal forceps, detachable, 90° curved up, working length 110mm
Pinza nasal, decomposable, 90° curva hacia arriba, longitud de trabajo 110mm
Pince nasale, desmontable, 90° courbée vers le haut, longueur de travail 110mm

441-675-25DT 2,5mm
441-675-30DT 3,0mm
441-675-35DT 3,5mm
441-675-40DT 4,0mm
441-675-50DT 5,0mm

BLAKESLEY "e-move"

Nasenzange, zerlegbar, durchschneidend, gerade, Arbeitslänge 110mm
Nasal forceps, detachable, through-cutting, straight, working length 110mm
Pinza nasal, decomposable, cortante, recta, longitud de trabajo 110mm
Pince nasale, desmontable, tranchante, droite, longueur de travail 110mm

441-690-25DT 2,5mm
441-690-35DT 3,5mm
441-690-40DT 4,0mm

Nasenzange, zerlegbar, durchschneidend 45° aufgebogen, Arbeitslänge 110mm
Nasal forceps, detachable, through-cutting, 45° curved up, working length 110mm
Pinza nasal, decomposable, cortante, 45° curva hacia arriba, longitud de trabajo 110mm
Pince nasale, desmontable, tranchante, 45° courbée vers le haut, longueur de travail 110mm

441-691-25DT 2,5mm
441-691-35DT 3,5mm
441-691-40DT 4,0mm

TAKAHASHI "e-move"

Nasenzange, zerlegbar, gerade, Arbeitslänge 110mm
Nasal forceps, detachable, straight, working length 110mm
Pinza nasal, decomposable, recta, longitud de trabajo 110mm
Pince nasale, desmontable, droite, longueur de travail 110mm

441-660-01DT 2,5x10mm
441-660-02DT 3,0x10mm
441-660-03DT 4,0x10mm

Nasenzange, aufgebogen, Arbeitslänge 110mm
Nasal forceps, detachable, curved up, working length 110mm
Pinza nasal, decomposable, curva hacia arriba, longitud de trabajo 110mm
Pince nasale, desmontable, courbée vers le haut, longueur de travail 110mm

441-661-01DT 2,5x10mm
441-661-02DT 3,0x10mm
441-661-03DT 4,0x10mm



ELCON

HNO - ENT - ORL

LUC

Septumzange, Gesamtlänge 200mm
Septum forceps, total length 200mm
Pinza para septum , longitud total 200mm
Pince pour septum, longueur totale 200mm

441-701 Fig.1
441-702 Fig.2

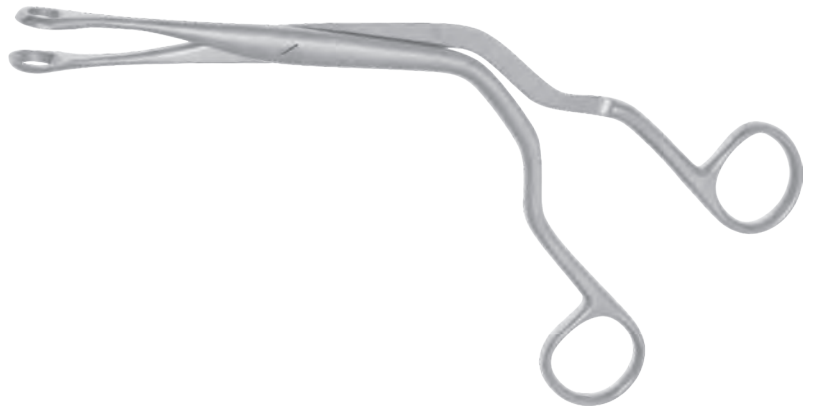

BRUENINGS

Septumzange, Arbeitslänge 110mm, Gesamtlänge 190mm
Septum forceps, working length 110mm, total length 190mm
Pinzara para septum, longitud de trabajo 110mm, longitud total 190mm
Pince pour septum, longueur de travail 110m, longueur totale 190mm

441-710 Fig.1
441-711 Fig.2
441-712 Fig.3



CRAIG

Septumzange, Arbeitslänge 90mm, Gesamtlänge 180mm
Septum forceps, working length 90mm, total length 180mm
Pinzara para septum, longitud de trabajo 90mm, longitud total 180mm
Pince pour septum, longueur de travail 90m, longueur totale 180mm

441-745 gerade / straight / recta / droite





JANSEN

Septumzange, Arbeitslänge 90mm, Gesamtlänge 190mm
Septum forceps, working length 90mm, total length 190mm
Pinza para septum, longitud de trabajo 90mm, longitud total 190mm
Pince pour septum, longueur de travail 90mm, longueur totale 190mm

441-810 ovaler Löffel / oval spoon
cuchara oval / cuillère ovale



JANSEN-MIDDLETON

Septumzange, Arbeitslänge 100mm, Gesamtlänge 190mm
Septum forceps, working length 100mm, total length 190mm
Pinza para septum, longitud de trabajo 100mm, longitud total 190mm
Pince pour septum longueur de travail 100mm, longueur totale 190mm

441-815 durchschneidend / trough-cutting
cortante / tranchante



BECKER

Septumschere, gezahnt, Arbeitslänge 95mm, Gesamtlänge 180mm
Septumscissors, serrated, working length 95mm, total length 180mm
Tijera para septum, dentada longitud de trabajo 95mm, longitud total 180mm
Ciseaux pour septum, dentelé, longueur de travail 95mm, longueur totale 180mm

441-425



KAZANJIAN

Knochensplitterzange, gerade, Gesamtlänge 185mm
Bone cutting forceps, straight, total length 185mm
Pinza cortante de huseo, recta, longitud total 185mm
Pince coupante à os, droite, longueur totale 185mm

451-120



CAPLAN

Nasenschere, abgewinkelt, gezahnte Schneiden, Gesamtlänge 220mm
Nasal scissors, angled on the flat, serrated blades, total length 220mm
Tijera nasal, angulada, hojas dentadas, longitud total 220mm
Ciseaux nasales, angulé, lames dentelées; longueur totale 220mm

451-111

ASCH

Septumrichtzange, abgewinkelt, Gesamtlänge 220mm
 Septum straightening forceps, angled, total length 220mm
 Pinza para alinear el septum, angulado, longitud total 220mm
 Pince pour dresser le septum, angulée, longueur totale 220mm

451-300



COTTLE-WALSHAM

Septumrichtzange, gerade, Gesamtlänge 230mm
 Septum straightening forceps, straight, total length 230mm
 Pinza para alinear el septum, recta, longitud total 230mm
 Pince pour dresser le septum, droite, longueur totale 230mm

451-310 für beide Seiten / for both side
 para ambos / pour les deux côtés



COTTLE-WALSHAM

Septumrichtzange, gerade, Gesamtlänge 230mm
 Septum straightening forceps, straight, total length 230mm
 Pinza para alinear el septum, recta, longitud total 230mm
 Pince pour dresser le septum, droite, longueur totale 230mm

451-313 rechts / right
 derecha / droite

451-314 links / left
 izquierda / gauche

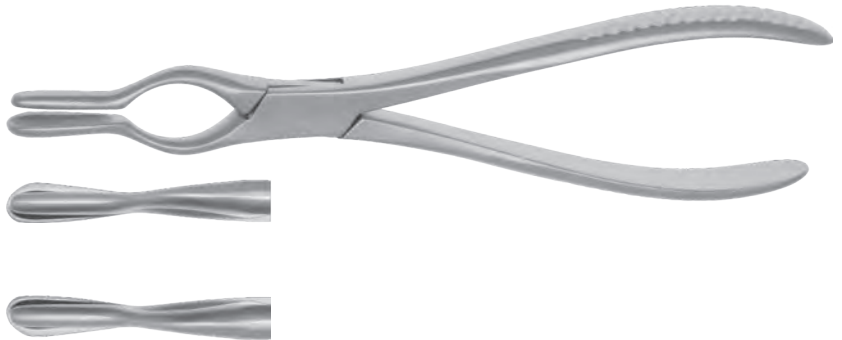

WALSHAM

Septumrichtzange, gerade, Gesamtlänge 220mm
 Septum straightening forceps, straight, total length 220mm
 Pinza para alinear el septum, recta, longitud total 220mm
 Pince pour dresser le septum, droite, longueur totale 220mm

451-318 zerlegbar / detachable
 desmontable / démontable



KRESSNER

Muschelquetschzange, Gesamtlänge 210mm
 Turbinate crushing forceps, total length 210mm
 Pinza aplastadora de cornete nasal, longitud total 210mm
 Pince écrasement cloison nasale, longueur totale 210mm

451-321 3,0mm breit / 3,0mm wide
 anchura 3,0mm / largeur 3,0mm

451-323 4,0mm breit / 4,0mm wide
 anchura 4,0mm / largeur 4,0mm

451-325 5,0mm breit / 5,0mm wide
 anchura 5,0mm / largeur 5,0mm

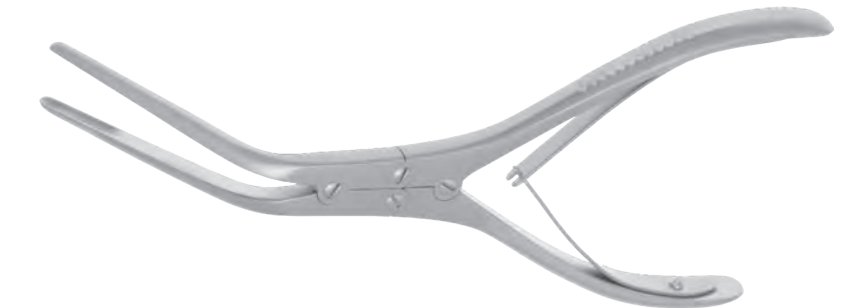

RUBIN

Knorpelquetschzange, mit Schutzkappe, Gesamtlänge 210mm
 Septum morcelizer, with protection guard, total length 210mm
 Pinza aplastadora de cartilago septum, con tapa de proteccion, longitud total 210mm
 Pince écrasement septum, avec douille de protection, longueur totale 210mm

451-331





FREER

Septummesser, Gesamtlänge 185mm
Septum knife, total length 185mm
Cuchillo para septum, longitud total 185mm
Couteau septum, longueur totale 185mm

440-400 Golfstock Form / golf club shape
forma palo de golf / forme crosse de golf



FREER

Mukosamesser, Gesamtlänge 150mm
Mucosal knife, total length 150mm
Cuchillo mucosa, longitud total 150mm
Couteau muqueuse, longueur totale 150mm

440-410



COTTLE

Septummesser, Gesamtlänge 150mm
Septum knife, total length 150mm
Cuchillo para septum, longitud total 150mm
Couteau septum, longueur totale 150mm

450-224



BALLENGER

Septum Schwingmesser, gerade, Gesamtlänge 190mm
Septum swivel knife, straight, total length 190mm
Cuchillo para septum movable, recto, longitud total 190mm
Couteau septum à lame mobile, droit, longueur totale 190mm

440-450 3,0mm breit / width 3,0mm
anchura 3,0mm / largeur 3,0mm

440-451 4,0mm breit / width 4,0mm
anchura 4,0mm / largeur 4,0mm

440-452 5,0mm breit / width 5,0mm
anchura 5,0mm / largeur 5,0mm



BALLENGER

Septum Schwingmesser, bajonett, Gesamtlänge 200mm
Septum swivel knife, bayonet, total length 200mm
Cuchillo para septum movable, bayoneta, longitud total 200mm
Couteau septum à lame mobile, baionnette, longueur totale 200mm

440-455 3,0mm breit / width 3,0mm
anchura 3,0mm / largeur 3,0mm

440-456 4,0mm breit / width 4,0mm
anchura 4,0mm / largeur 4,0mm

440-457 5,0mm breit / width 5,0mm
anchura 5,0mm / largeur 5,0mm

McKENTY

Elevatorium, Gesamtlänge 150mm
Elevator, total length 150mm
Elevador, longitud total 150mm
Décolleur, longueur totale 150mm

- 440-600-04** 4,0mm breit / width 4,0mm
anchura 4,0mm / largeur 4,0mm
440-600-05 5,0mm breit / width 5,0mm
anchura 5,0mm / largeur 5,0mm



KILLIAN

Doppelelevatorium, scharf/stumpf
Elevator, double ended, sharp/blunt
Elevador, doble, agudo/romo
Décolleur double, tranchant/mousse

- 440-603** Gesamtlänge 180mm / total length 180mm
longitud total 180mm / longueur totale 180mm
440-604 Gesamtlänge 220mm / total length 220mm
longitud total 220mm / longueur totale 220mm



FREER

Elevatorium, Gesamtlänge 190mm, 4,5mm breit
Elevator, total length 190mm, width 4,5mm
Elevador, longitud total 190mm, anchura 4,5 mm
Décolleur, longueur totale 190mm, largeur 4,5mm

- 440-615** scharf / sharp / agudo / tranchant
440-616 stumpf / blunt / romo / mousse



FREER

Doppelelevatorium, scharf/stumpf, 4,5mm breit
Elevator, double ended, sharp/blunt, width 4,5mm
Elevador, doble, agudo/romo, anchura 4,5mm
Décolleur double, tranchant/mousse, largeur 4,5mm

- 440-620** Gesamtlänge 185mm / total length 185mm
longitud total 185mm / longueur totale 185mm
440-622 Gesamtlänge 200mm / total length 200mm
longitud total 200mm / longueur totale 200mm



FREER

Doppelelevatorium, scharf/stumpf, 6,5mm breit
Elevator, double ended, sharp/blunt, width 6,5mm
Elevador, doble, agudo/romo, anchura 6,5mm
Décolleur double, tranchant/mousse, largeur 6,5mm

- 440-621** Gesamtlänge 200mm / total length 200mm
longitud total 200mm / longueur totale 200mm



FREER-YASARGIL

Doppelelevatorium, scharf/stumpf, 3,0mm breit
Elevator, double ended, sharp/blunt, width 3,0mm
Elevador, doble, agudo/romo, anchura 3,0mm
Décolleur double, tranchant/mousse, largeur 3,0mm

- 440-627** Gesamtlänge 185mm / total length 185mm
longitud total 185mm / longueur totale 185mm



Doppelelevatorium mit Kugelenden, Gesamtlänge 180mm
Ball ended elevator, double ended, total length 180mm
Elevador doble con puntas de bolas, longitud total 180mm
Décolleur double bouts bille, longueur totale 180mm

- 440-630** Ø 2,0mm / Ø 2,8mm



GORNEY

Saugelevatorium, Gesamtlänge 190mm
Suction elevator, total length 190mm
Elevador de aspiración, longitud total 190mm
Décolleur aspiration, longueur totale 190mm

- 440-694** 3,0mm breit / width 3,0mm
anchura 3,0mm / largeur 3,0mm





HALLE

Elevatorium, Gesamtlänge 180mm
Elevator, total length 180mm
Elevador, longitud total 180mm
Décolleur, longueur totale 1850mm

440-612 3,3mm breit / width 3,3mm
anchura 3,3mm / largeur 3,3mm



BALLENGER-HAJEK

Doppelelevatorium, scharf/stumpf, 6,0mm breit
Elevator, double ended, sharp/blunt, width 6,0mm
Elevador, doble, agudo/romo, anchura 6,0mm
Décolleur double, tranchant/mousse, largeur 6,0mm

440-645 Gesamtlänge 200mm / total length 200mm
longitud total 200mm / longueur totale 200mm



PENNINGTON

Doppelelevatorium, rechts und links gebogen,
Elevator, double ended, curved right and left,
Elevador doble, curva a la derecha y izquierda,
Décolleur double, courbé vers la droite et gauche,

440-640 Gesamtlänge 210mm / total length 210mm
longitud total 210mm / longueur totale 210mm



LEMPERT

Raspatorium, leicht gebogen, Gesamtlänge 170mm
Raspatory, slightly curved, total length 170mm
Raspador, ligeramente curvado, longitud total 170mm
Raspatoire, courbe legerement, longueur totale 170mm

450-700 2,0mm breit / width 2,0mm
anchura 2,0mm / largeur 2,0mm

450-701 3,0mm breit / width 3,0mm
anchura 3,0mm / largeur 3,0mm

450-702 4,0mm breit / width 4,0mm
anchura 4,0mm / largeur 4,0mm

450-703 5,0mm breit / width 5,0mm
anchura 5,0mm / largeur 5,0mm



MASING

Doppelelevatorium, graduiert, scharf/stumpf
Elevator, double ended, graduated, sharp/blunt
Elevador, doble, graduado, agudo/romo
Décolleur double, gradué, tranchant/mousse

450-715-21 Gesamtlänge 210mm / total length 210mm
longitud total 210mm / longueur totale 210mm



COTTLE

Doppelelevatorium, graduiert
Elevator, double ended, graduated
Elevador, doble, graduado
Décolleur double, gradué

450-716 Gesamtlänge 210mm / total length 210mm
longitud total 210mm / longueur totale 210mm

450-718 Gesamtlänge 225mm / total length 225mm
longitud total 225mm / longueur totale 225mm



COTTLE

Doppeleraspatorium, zur Tunnelung, Gesamtlänge 230mm
Raspatory, double ended, for tunneling, total length 230mm
Raspador, doble, para tunalización, longitud total 230mm
Raspatoire double, pour percement tunnel, longueur totale 230mm

450-733



McKENTY

Doppeleraspatorium, Gesamtlänge 220mm
Raspatory, double ended, total length 220mm
Raspador, doble, longitud total 220mm
Raspatoire double, longueur totale 220mm

450-732

FREER

Septum Meißel, 4mm breit, Gesamtlänge 165mm
Septum chisel, width 4mm, total length 165mm
Cinzel septum, anchura 4mm, longitud total 165mm
Burin septum, largeur 4mm, longueur totale 165mm

- 440-500** gerade / straight / recto / droit
440-501 leicht gebogen / slightly curved
curvado ligeramente / courbé légèrement



KILLIAN-CLAUS

Septum Hohlmeißel, bajonett, 5mm breit, Gesamtlänge 160mm
Septum gouge, bayonet, width 5mm, total length 160mm
Gubia septum, bayoneta, anchura 5mm, longitud total 160mm
Gouge septum, baïonnette, larg.5mm, long.totale 160mm

- 440-591** gerade / straight
recta / droite
440-593 V-Form / V-shaped
forma V / forme V



CAROLL

Osteotom, gerade, graduiert, Gesamtlänge 140mm
Osteotome, straight, graduated, total length 140mm
Osteotomo, recto, graduado, longitud total 140mm
Ostéotome, droit, gradué, longueur totale 140mm

- 440-530** 3mm
440-532 6mm
440-534 10mm
440-536 12mm



SHEEHAN / RUBIN

Osteotom, gerade, Sechskant-Griff, Gesamtlänge 160mm
Osteotome, straight, hexagonal handle, total length 160mm
Osteotomo, recto, mango hexagonal, longitud total 160mm
Ostéotome, droit, manche hexagonal, long.totale 160mm

- 450-302** 2mm
450-303 3mm
450-304 4mm
450-305 5mm
450-306 6mm
450-307 7mm
450-308 8mm
450-309 9mm
450-310 10mm
450-311 11mm
450-312 12mm



WALTER

Osteotom, Gesamtlänge 190mm
Osteotome, total length 190mm
Osteotomo, longitud total 190mm
Ostéotome, longueur totale 190mm

- 450-291-02** 2mm
450-291-03 3mm
450-291-04 4mm
450-291-07 7mm
450-291-09 9mm
450-291-12 12mm



WALTER

Hohlmeißel, Gesamtlänge 190mm
Gouge, total length 190mm
Gubia, longitud total 190mm
Gouge, longueur totale 190mm

- 450-292-03** 3mm
450-292-04 4,5mm





COTTLE

Osteotom, gerade, graduert, Gesamtlänge 180mm
Osteotome, straight, graduated, total length 180mm
Osteotomo, recto, graduado, longitud total 180mm
Ostéotome, droit, gradué, longueur totale 180mm

450-320	4mm
450-322	6mm
450-323	7mm
450-324	8mm
450-325	9mm
450-328	12mm



COTTLE

Osteotom, gebogen, graduert, Gesamtlänge 180mm
Osteotome, curved, graduated, total length 180mm
Osteotomo, curvado, graduado, longitud total 180mm
Ostéotome, courbé, gradué, longueur totale 180mm

450-330	4mm
450-332	6mm



COTTLE

Meißel, gerade, graduert, Gesamtlänge 180mm
Chisel, straight, graduated, total length 180mm
Cinzel, recto, graduado, longitud total 180mm
Burin, droit, gradué, longueur totale 180mm

450-334	4mm
450-335	7mm
450-336	9mm
450-337	12mm



RUBIN

Osteotom, gerade, mit Halteknopf, Gesamtlänge 160mm
Osteotome, straight, with stabilizer, total length 160mm
Osteotomo, recto, con boton de soporte, longitud total 160mm
Ostéotome, droit, avec bouton support, long. totale 160mm

450-352	10mm
450-353	12mm
450-354	14mm
450-355	16mm



CINELLI

Osteotom, Führungsdorn beidseitig, Gesamtlänge 160mm
Osteotome, double guard, total length 160mm
Osteotomo, 2 mandrils de guía, longitud total 160mm
Ostéotome, 2 mandrins de guidage, long. totale 160mm

450-345	10mm
450-346	12mm
450-347	14mm
450-348	16mm



SILVER / MASING

Osteotom, einseitiger Führungsdorn, Gesamtlänge 175mm
Osteotome, single rounded guard, total length 175mm
Osteotomo, 1 mandril de guía, longitud total 175mm
Ostéotome, 1 mandrin de guidage, longueur totale 175mm

450-370	gerade / straight / recto / droit
450-371	links gebogen / curved left curva izquierda / courbé gauche
450-373	rechts gebogen / curved right curva derecha / courbé droite

COTTLE

Meißel, gerade, graduert, mit Quersteg, Gesamtlänge 180mm
Chisel, straight, graduated, with crossbar, total length 180mm
Cinzel, recto, graduado, barra transversal longitud total 180mm
Burin, droit, gradué, avec linsoir, longueur totale 180mm

450-270-02 2mm
450-270-04 4mm
450-270-07 7mm
450-270-09 9mm
450-270-12 12mm



COTTLE

Hammer, Aluminiumgriff, Gesamtlänge 190mm
Mallet, aluminium handle, total length 190mm
Martillo, mango de aluminio, longitud total 190mm
Marteau, manche aluminium, longueur totale 190mm

450-390 300g



HAJEK

Hammer, Metall massiv, Gesamtlänge 205mm
Mallet, metal, total length 205mm
Martillo, de metal masivo, longitud total 205mm
Marteau, métal plein, longueur totale 205mm

410-610 200g



VICKERS

Hammer, Aluminiumgriff, 2 auswechselbare Kunststoffbacken,
Gesamtlänge 180mm
Mallet, aluminium handle, 2 exchangeable plastic discs, total length
180mm
Martillo, mango de aluminio, 2 discos de plástico intercambiable,
longitud total 180mm
Marteau, manche aluminium, 2 disques en plastique échangeables,
longueur totale 180mm

410-623 185g

Ersatzbacken (Paar), Kunststoff (kein Medizinprodukt)
Spare Facings (pair), plastic (no medical device)
Tapas de repuesto (par), plástico (no es un producto sanitario)
Plaques de rechange (paire), plastique (pas de produit médical)

410-624





MASING

Knorpelritzmesser, leicht gebogen, Gesamtlänge 140mm
Cartilage slitting knife, slightly curved, total length 140mm
Cuchillo para rajar el cartilago, curvo ligeramente, longitud total 140mm
Couteau pour entamer le cartilage, courbé légèrement, longueur totale 140mm

450-241 spitz, sharp, agudo, pointu



JOSEPH

Nasenplastikmesser, gerade, geknöpft, Gesamtlänge 150mm
Rhinoplastic knife, straight, button-end, total length 150mm
Cuchillo de rinoplastia, recto, punta abotonada, longitud total 150mm
Couteau de rhinoplastie, droit, pointe boutonnée, longueur totale 150mm

450-210



JOSEPH

Nasenplastikmesser, zweiseitig, scharfe Spitze, Gesamtlänge 150mm
Rhinoplastic knife, double edged, sharp tip, total length 150mm
Cuchillo de rinoplastia, doble filo, punta aguda, longitud total 150mm
Couteau de rhinoplastie, double tranchant, pointe tranchante, longueur totale 150mm

450-202 gerade / straight / recto / droit

450-203 gebogen/ curved / curvo / courbé



JOSEPH

Nasenplastikmesser, zweiseitig, stumpfe Spitze, Gesamtlänge 150mm
Rhinoplastic knife, double edged, blunt tip, total length 150mm
Cuchillo de rinoplastia, doble filo, punta roma, longitud total 150mm
Couteau de rhinoplastie, double tranchant, pointe mousse, longueur totale 150mm

450-206 gerade / straight / recto / droit

450-207 gebogen/ curved / curvo / courbé



JOSEPH

Nasenplastikmesser, gewinkelt, geknöpft, Gesamtlänge 160mm
Rhinoplastic knife, angled, button-end, total length 160mm
Cuchillo de rinoplastia, angulado, punta abotonada, longitud total 160mm
Couteau de rhinoplastie, coudé, pointe boutonnée, longueur totale 160mm

450-211

COTTLE

Häkchen, 1 zinkig, scharf, Gesamtlänge 145mm
 Hook, 1 prong, sharp, total length 145mm
 Gancho, 1 diente, agudo, longitud total 145mm
 Crochet, 1 griffe, pointu, longueur totale 145mm

- 450-822 Fig.1
- 450-823 Fig.2
- 450-824 Fig.3



FOMON

Doppel-Häkchen, 2 zinkig, geknöpft Gesamtlänge 165mm
 Double hook, 2 prongs, button end, total length 165mm
 Gancho doble, 2 dientes, punta abotonada, longitud total 165mm
 Crochet double, 2 griffes, boutonné, longueur totale 165mm

450-852

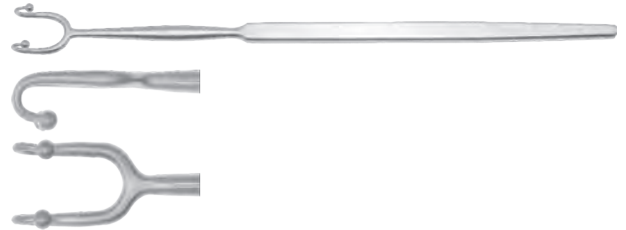

CONVERSE

Nasenflügel Doppel-Häkchen, 2 zinkig, stumpf, Gesamtlänge 120mm
 Alar double hook, double ended, 2 prongs, blunt, total length 120mm
 Gancho doble para aleta nasal, 2 dientes, romo, longitud total 120mm
 Crochet double pour aile du nez, 2 griffes, mousse, longueur totale 120mm

450-880



KILNER

Nasenflügel Doppel-Häkchen, 2 zinkig, Gesamtlänge 80mm
 Alar double hook, 2 prongs, total length 80mm
 Gancho doble para aleta nasal, 2 dientes, longitud total 80mm
 Crochet double pour aile du nez, 2 griffes, longueur totale 80mm

- 450-890 10mm scharf / sharp / agudo / pointu
- 450-891 13mm scharf / sharp / agudo / pointu
- 450-892 10mm stumpf/ blunt / romo / mousse



JOSEPH

Doppel-Häkchen, 2 zinkig, scharf, Gesamtlänge 160mm
 Double hook, 2 prongs, sharp, total length 160mm
 Gancho doble, 2 dientes, agudo, longitud total 160mm
 Crochet double, 2 griffes, pointu, longueur totale 160mm

- 450-832 2mm
- 450-835 5mm
- 450-837 7mm
- 450-840 10mm



FREER

Doppel-Häkchen, 2 zinkig, scharf, Gesamtlänge 150mm
 Double hook, 2 prongs, sharp, total length 150mm
 Gancho doble, 2 dientes, agudo, longitud total 150mm
 Crochet double, 2 griffes, pointu, longueur totale 150mm

450-842



COTTLE

Fingerringhäkchen, 2 zinkig, scharf, Gesamtlänge 55mm
 Finger ring hook, 2 prongs, sharp, total length 55mm
 Gancho anillo, 2 dientes, agudo, longitud total 55mm
 Crochet bague, 2 griffes, pointu, longueur totale 55mm

450-843 10mm





COTTLE

Doppel-Häkchen, 2 zinkig, 10mm breit, Gesamtlänge 150mm
Double hook, 2 prongs, width 10mm, total length 150mm
Gancho doble, 2 dientes, anchura 10 mm, longitud total 150mm
Crochet double, 2 griffes, largeur 10 mm, longueur totale 150mm

450-844 beide Seiten scharf
both prongs sharp
ambos lados agudos
deux côtés pointus



450-847

rechts geknöpft, links scharf
right prong button ended, left prong sharp
derecha abotonado, izquierda agudo
boutonné à la droite, pointu à la gauche



450-848

rechts scharf, links geknöpft
right prong sharp, left prong button ended
derecha agudo, izquierda abotonado
pointu à la droite, boutonné à la gauche



COTTLE

Nasenhaken, 4 zinkig, stumpf, Gesamtlänge 130mm
Nasal retractor, 4 prongs, blunt, total length 130mm
Gancho nasal, 4 dientes, romo, longitud total 130mm
Crochet nasal, 4 griffes, mousse, longueur totale 130mm

450-846



COTTLE

Nasenflügelhalter, Gesamtlänge 140mm
Alar retractor, total length 140mm
Gancho para aleta nasal, longitud total 140mm
Crochet pour aile du nez, longueur totale 140mm

450-910



COTTLE

Nasenflügelhalter, Gesamtlänge 150mm
Alar retractor, total length 150mm
Gancho para aleta nasal, longitud total 150mm
Crochet pour aile du nez, longueur totale 150mm

450-914



NEIVERT

Doppelhaken aus Draht, Nasenflügelhaken / flacher Haken mit
Messerführung, Gesamtlänge 185mm
Retractor, double ended wire-shaped, alar retractor / flat retractor with knife
guide, total length 185mm
Doble gancho de alambre, para aleta nasal / gancho plano con guía de
sierra, longitud total 185mm
Crochet double en fils métallique, pour aile du nez / crochet plat avec guide
de scie, longueur totale 185mm

450-250

COTTLE-NEIVERT

Doppelhaken, 2 zinkig, geknöpft / flacher Haken mit Messerführung,
Gesamtlänge 190mm
Retractor, double ended, 2 prongs button end / flat retractor with knife
guide, total length 190mm
Doble gancho, 2 dientes punta abotonada / gancho plano con guía de
sierra, longitud total 190mm
Crochet double, 2 griffes, boutonné / crochet plat avec guide de scie,
longueur totale 190mm

450-251



AUFRICHT

Nasentrückenhaken, Gesamtlänge 160mm
Nasal bridge retractor, total length 160mm
Retractor para dorso de la nariz, longitud total 160mm
Ecarteur pour dos du nez, longueur totale 160mm

450-900 45x8mm

450-901 60x8mm



WALTER

Nasentrückenhaken / Doppel-Haken, Gesamtlänge 130mm
Nasal bridge retractor / double hook, total length 130mm
Retractor para dorso de la nariz, doble gancho, longitud total 130mm
Ecarteur pour dos du nez, double, longueur totale 130mm

450-905



SENN-MILLER

Doppelhaken, 3 zinkig / Blatt 22x7mm, Gesamtlänge 160mm
Retractor, double ended, 3 prongs / blade 22x7mm, total length 160mm
Retractor doble, 3 dientes / hoja 22x7mm, longitud total 160mm
Crochet double, 3 griffes / lame 22x7mm, longueur totale 160mm

160-300 scharf / sharp / agudo / pointu

160-301 stumpf / blunt / romo / mousse



KILNER

Doppelhaken, 3 zinkig / Blatt 16x5mm, Gesamtlänge 155mm
Retractor, double ended, 3 prongs / blade 16x5mm, total length 155mm
Retractor doble, 3 dientes / hoja 16x5mm, longitud total 155mm
Crochet double, 3 griffes / lame 16x5mm, longueur totale 155mm

450-856 scharf / sharp / agudo / pointu

450-857 stumpf / blunt / romo / mousse



RAGNELL

Doppelhaken, Blatt 18x5mm / 10x3mm, Gesamtlänge 150mm
Retractor, double ended, blade 18x5mm / 10x3mm, total length 150mm
Retractor doble, hoja 18x5mm / 10x3mm, longitud total 150mm
Crochet double, lame 18x5mm / 10x3mm, longueur totale 150mm

450-862



Hartmetalleinlagen / Tungsten carbide inlays / Insertos de carburo tungsteno / Inserts de carbure tungstène



Fig.1 grob / coarse / grueso / grosse
 12 Zähne / 12 teeth / 12 dientes / 12 dents



Fig.2 grob / coarse / grueso / grosse
 14 Zähne / 14 teeth / 14 dientes / 14 dents



Fig.3 grob / coarse / grueso / grosse
 16 Zähne / 16 teeth / 16 dientes / 16 dents



Fig.4 mittel / medium / mediano / moyen
 20 Zähne / 20 teeth / 20 dientes / 20 dents



Fig.5 mittel / medium / mediano / moyen
 24 Zähne / 24 teeth / 24 dientes / 24 dents



Fig.6 mittel / medium / mediano / moyen
 30 Zähne / 30 teeth / 30 dientes / 30 dents

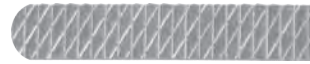

Fig.7 fein / fine / fino / fine
 36 Zähne / 36 teeth / 36 dientes / 36 dents



Fig.8 fein / fine / fino / fine
 44 Zähne / 44 teeth / 44 dientes / 44 dents



Fig.9 fein / fine / fino / fine
 52 Zähne / 52 teeth / 52 dientes / 52 dents



Fig.10 fein / fine / fino / fine
 62 Zähne / 62 teeth / 62 dientes / 62 dents

FOMON

Nasenraspel, doppelseitig, mit Hartmetalleinlagen Gesamtlänge 205mm
 Nasal rasp, double ended, with TC inlays, total length 205mm
 Raspa nasal, doble, con insertos de TC, longitud total 205mm
 Râpe nasale, double, avec inserts de TC, longueur totale 205mm



- 450-590 Fig.1 / Fig.2
- 450-591 Fig.3 / Fig.4
- 450-592 Fig.5 / Fig.6
- 450-593 Fig.7 / Fig.8
- 450-594 Fig.9 / Fig.10

MALTZ

Nasenraspel, mit Hartmetalleinlagen Gesamtlänge 210mm
 Nasal rasp, with TC inlays, total length 210mm
 Raspa nasal, con insertos de TC, longitud total 210mm
 Râpe nasal, avec inserts de TC, longueur totale 210mm



- 450-560-01 Fig.1
- 450-560-02 Fig.2
- 450-560-03 Fig.3
- 450-560-04 Fig.4
- 450-560-05 Fig.5
- 450-560-06 Fig.6
- 450-560-07 Fig.7
- 450-560-08 Fig.8

MILLER

Nasenraspel, doppelseitig, mit Hartmetalleinlagen Gesamtlänge 180mm
 Nasal rasp, double ended, with TC inlays, total length 180mm
 Raspa nasal, doble, con insertos de TC, longitud total 180mm
 Râpe nasale, double, avec inserts de TC, longueur totale 180mm



- 450-574 quer gerieft / horizontal serration
 estriado horizontal / strié horizontalement
- 450-575 kreuzgerieft / crossed serration
 estriado cruzado / strié croisé

MALTZ

Nasenraspel, mit Hartmetalleinlagen, mit Blutrinne,
 Gesamtlänge 165mm
 Nasal rasp, with TC inlays, with blood groove, total length 165mm
 Raspa nasal, con insertos de TC, con ranura para sangre,
 longitud total 165mm
 Râpe nasale, avec inserts de TC, avec rainure de sang,
 longueur totale 165mm



- 450-586 auf Zug schneidend / down cutting
 cortante en tirante / tranchant en tirant
- 450-587 auf Druck schneidend / up cutting
 cortante en trazar / tranchant en poussant

AUFRICHT

Glabella Nasenraspel, mit Hartmetalleinlagen, Gesamtlänge 205mm
 Glabella Nasal rasp, with TC inlays, total length 205mm
 Glabella Raspa nasal, con insertos de TC, longitud total 205mm
 Glabella râpe nasale, avec inserts de TC, longueur totale 205mm



- 450-589

JOSEPH

Nasenraspel, Gesamtlänge 170mm
Nasal rasp, total length 170mm
Raspa nasal, longitud total 170mm
Râpe nasale, longueur totale 170mm

- 450-500** fein / fine / fino / fine
450-501 grob / coarse / grueso / grosse



MALTZ

Nasenraspel, mit Blutrinne, Gesamtlänge 175mm
Nasal rasp, with blood groove, total length 175mm
Raspa nasal, con ranura para sangre, longitud total 175mm
Râpe nasale, avec rainure de sang, longueur totale 175mm

- 450-518** auf Zug schneidend / down cutting
cortante en tirante / tranchant en tirant
450-519 auf Druck schneidend / up cutting
cortante en trazar / tranchant en poussant



COTTLE

Nasenraspel, Gesamtlänge 210mm
Nasal rasp, total length 210mm
Raspa nasal, longitud total 210mm
Râpe nasale, longueur totale 210mm

- 450-520** auf Zug schneidend / down cutting
cortante en tirante / tranchant en tirant



AUFRICHT

Glabella Nasenraspel, 9mm breit, Gesamtlänge 210mm
Glabella nasal rasp, width 9mm, total length 210mm
Glabella raspa nasal, anchura 9mm, longitud total 210mm
Glabella râpe nasale, largeur 9mm, longueur totale 210mm

- 450-530** auf Zug schneidend / down cutting
cortante en tirante / tranchant en tirant
450-531 auf Druck schneidend / up cutting
cortante en trazar / tranchant en poussant



AUFRICHT

Glabella Nasenraspel, 8mm breit, Gesamtlänge 210mm
Glabella nasal rasp, width 8mm, total length 210mm
Glabella raspa nasal, anchura 8mm, longitud total 210mm
Glabella râpe nasale, largeur 8mm, longueur totale 210mm

- 450-532** auf Zug und Druck schneidend / up and down cutting
cortante en tirante y en trazar / coupant en tirant et en poussant



FOMON-MASING

Nasenraspel, doppelseitig, Gesamtlänge 210mm
Nasal rasp, double ended, total length 210mm
Raspa nasal, doble, longitud total 210mm
Râpe nasale, double, longueur totale 210mm

- 450-540** fein / fine / fino / fine
450-542 grob / coarse / grueso / grosse



FOMON (KLEINERT-KUTZ)

Nasenraspel, doppelseitig, Gesamtlänge 210mm
Nasal rasp, double ended, total length 210mm
Raspa nasal, doble, longitud total 210mm
Râpe nasale, double, longueur totale 210mm

- 450-548** flache Seite fein / konvexe Seite grob
flat side fine / convex side coarse
lado plano fino / lado convexo grueso
côté plat fine / côté convexe grosse



Diamant Nasenraspeln ermöglichen durch die Diamantbeschichtung ein leichteres, präziseres und gleichmäßigeres Abtragen des Knochens.
The diamond nasal rasps allow, due to their diamond coating, an easier, more precise and uniform removal of the bone.
Raspa nasal diamantada, permite por el recubrimiento de diamante una eliminación más ligero, más preciso y más proporcionado del hueso.
Les râpes nasales diamantées permettent, par leur couche diamantée, l'enlèvement plus facile, précis et uniforme de l'os.



COTTLE

Diamant Nasenraspel, Gesamtlänge 205mm
Diamond nasal rasp, total length 205mm
Raspa nasal diamantada, longitud total 205mm
Râpe nasale diamantée, longueur totale 205mm

450-562



AUFRIECHT

Diamant Nasenraspel, Gesamtlänge 205mm
Diamond nasal rasp, total length 205mm
Raspa nasal diamantada, longitud total 205mm
Râpe nasale diamantée, longueur totale 205mm

450-563



Diamant Nasenraspel, Gesamtlänge 190mm
Diamond nasal rasp, total length 190mm
Raspa nasal diamantada, longitud total 190mm
Râpe nasale diamantée, longueur totale 190mm

450-564

gerade / straight / recta / droit

450-565

rückwärts gebogen / curved backwards
curva hacia atras / courbée vers l'arrière



FOMON

Diamant Nasenraspel, dopelseitig, Gesamtlänge 205mm
Diamond nasal rasp, double ended, total length 205mm
Raspa nasal diamantada, doble, longitud total 205mm
Râpe nasale diamantée, double, longueur totale 205mm

450-566

JOSEPH

Nasensäge, Gesamtlänge 180mm
Nasal saw, total length 180mm
Sierra nasal, longitud total 180mm
Scie nasale, longueur totale 180mm

450-410 gerade / straight / recta / droite



JOSEPH

Nasensäge, Gesamtlänge 190mm
Nasal saw, total length 190mm
Sierra nasal, longitud total 190mm
Scie nasale, longueur totale 190mm

450-412 bajonett-förmig rechts / bayonet shaped right
bayoneta derecha / baïonnette, vers la droite

450-413 bajonett-förmig links / bayonet shaped left
bayoneta izquierda / baïonnette, vers la gauche



JOSEPH

Nasensäge, kniegebogen, Gesamtlänge 160mm
Nasal saw, angled, total length 160mm
Sierra nasal, angulada, longitud total 160mm
Scie nasale, angulée, longueur totale 160mm

450-420

450-421



COTTLE

Knochen- und Knorpelquetscher
Bone and cartilage crusher
Aplastador de huesos y cartilagos
Ecraseur d'os et cartilage

450-490





LICHTWITZ

Kiefernhöhlepunktionsnadel, Arbeitslänge 100mm
Antrum trocar needle, working length 100mm
Aguja de punción de seno maxilar, longitud de trabajo 100mm
Aiguille de ponction sinus maxillaire, longueur de travail 100mm

190-460	Ø 1,5mm
190-461	Ø 1,8mm
190-462	Ø 2,0mm



EICKEN

Kiefernhöhlepunktionsnadel, Spitze mit seitlichen Öffnungen,
Arbeitslänge 100mm
Antrum trocar needle, tip with lateral holes, working length 100mm
Aguja de punción seno maxilar, punta c. aberturas laterales,
longitud de trabajo 100mm
Aiguille de ponction sinus maxillaire, pointe à ouvertures latérales,
longueur de travail 100mm

190-470	Ø 1,5mm
190-471	Ø 1,8mm
190-472	Ø 2,0mm



Septumkanüle, LUER-lock, abgewinkelt
Septum needle, LUER-lock, angled
Aguja para el tabique, LUER-lock, angulada
Aiguille cloison, LUER-lock, angulées

198-813	Ø 0,8mm
----------------	---------

EICKEN

Kiefernhöhle Spülkanüle, LUER-lock, kurze Biegung, Gesamtlänge 150mm
Antrum cannula, LUER-lock, short curved, total length 150mm
Canula de irrigacion seno maxilar, LUER-lock, curva corta, longitud 150mm
Canule irrigation sinus maxillaire, LUER-lock, courbe courte, long. 150mm

- 440-943-25** Ø 2,5mm
- 440-943-30** Ø 3,0mm
- 440-943-40** Ø 4,0mm



EICKEN

Kiefernhöhle Spülkanüle, LUER-lock, lange Biegung, Gesamtlänge 150mm
Antrum cannula, LUER-lock, long curved, total length 150mm
Canula de irrigacion seno maxilar, LUER-lock, curva larga, longitud 150mm
Canule irrigation sinus maxillaire, LUER-lock, courbe longue, long. 150mm

- 440-946-25** Ø 2,5mm
- 440-946-30** Ø 3,0mm
- 440-946-40** Ø 4,0mm



- 440-946-25M** Ø 2,5mm biegsam / malleable / maleable / malléable
- 440-946-30M** Ø 3,0mm biegsam / malleable / maleable / malléable
- 440-946-40M** Ø 4,0mm biegsam / malleable / maleable / malléable

RITTER

Stirnhöhlenbougie, Gesamtlänge 155mm
Frontal sinus bougie, total length 155mm
Bougie seno frontal, longitud total 155mm
Bougie sinus frontal, longueur totale 155mm

- 440-992** Ø 2,5mm
- 440-993** Ø 3,0mm
- 440-994** Ø 4,0mm





Stirnhöhlen Doppelsonde Fig.2 Länge 220mm, 90° gebogen, ein Ende gerade, ein Ende nach innen abgewinkelt
 Frontal sinus seeker double ended Fig.2 length 220mm, 90°curved, one tip straight, one tip angled inwards
 Doble sonda seno frontal Fig.2, longitud 220mm, 90°curva, una punta recta una punta angulada hacia adentro
 Sonde sinus frontal double Fig. 2, longueur 220mm, courbée 90°, une pointe droite, l'autre coudée vers l'intérieur

441-195-02



Stirnhöhlen Doppelsonde Fig.3 Länge 220mm, 77° gebogen, beide Enden nach außen abgewinkelt
 Frontal sinus seeker double ended Fig.3 length 220mm, 77°curved, both tips angled outwards
 Doble sonda seno frontal Fig.3, longitud 220mm, 77° curva, ambas puntas anguladas hacia afuera
 Sonde sinus frontal double Fig. 3, longueur 220mm, courbée 77°, les deux pointes coudées vers l'extérieur

441-195-03



Stirnhöhlen Doppelsonde Fig.4 Länge 220mm, 90° gebogen, ein Ende nach links abgewinkelt, ein Ende nach rechts abgewinkelt
 Frontal sinus seeker double ended Fig.4 length 220mm, 90°curved, one tip angled to the left, one tip angled to the right
 Doble sonda seno frontal Fig.4, longitud 220mm, 90° curva, una punta angulada a la izquierda, una punta angulada a la derecha
 Sonde sinus frontal double Fig. 4, longueur 220mm, courbée 90°, une pointe coudée vers la gauche, l'autre vers la droite

441-195-04



Stirnhöhlen Doppelsonde Fig.5 Länge 220mm, 77° gebogen, ein Ende nach links abgewinkelt, ein Ende nach rechts abgewinkelt
 Frontal sinus seeker double ended Fig.5 length 220mm, 77°curved, one tip angled to the left, one tip angled to the right
 Doble sonda seno frontal Fig.5, longitud 220mm, 77° curva, una punta angulada a la izquierda, una punta angulada a la derecha
 Sonde sinus frontal double Fig. 5, longueur 220mm, courbée 77°, une pointe coudée vers la gauche, l'autre vers la droite

441-195-05



Stirnhöhlen Doppelsonde Fig.6 Länge 220mm, 77° gebogen, ein Ende gerade, ein Ende nach innen abgewinkelt
 Frontal sinus seeker double ended Fig.6 length 220mm, 77°curved, one tip straight, one tip angled inwards
 Doble sonda seno frontal Fig.6, longitud 220mm, 77° curva, una punta recta, una punta angulada hacia adentro
 Sonde sinus frontal double Fig. 6, longueur 220mm, courbée 77°, une pointe droite, l'autre coudée vers l'intérieur

441-195-06



Stirnhöhlen-Ostium Doppelsonde Länge 210mm, ein Ende leicht gebogen, ein Ende 90° gebogen
 Frontal sinus ostium seeker double ended 210mm, one tip slightly curved, one tip 90° curved
 Doble sonda osium seno frontal 210mm, una punta ligeramente curvada, la otra a 90°
 Sonde ostium sinus frontal double 210mm, une pointe courbée légère, l'autre courbée 90°

441-192-01



Kieferhöhlen Ostium Doppelsonde, 205mm
 Maxillary ostium seeker double ended, 205mm
 Doble sonda ostium seno maxilar, 205mm
 Sonde double ostium du sinus maxillaire, 205mm

441-192-02 Ø 1,0mm/2,0mm

441-192-03 Ø 2,0mm/2,5mm

**KIEFERHÖHLEN UND STIRNHÖHLEN LÖFFEL
ANTRUM AND FRONTAL SINUS CURETTES
CURETA PARA SENO MAXILAR Y SINUS FRONTAL
CURETTE SINUS MAXILLAIRE ET SINUS FRONTAL**

ELCON
HNO - ENT - ORL

Kieferhöhlenlöffel, oval, Gesamtlänge 190mm
Antrum curette, oval, total length 190mm
Cureta seno maxilar, oval, longitud total 190mm
Curette sinus maxillaire, ovale, longueur totale 190mm

- 441-200** Fig.1
441-202 Fig.2
441-203 Fig.3



Kieferhöhlenlöffel, aufgewinkelt, Gesamtlänge 190mm
Antrum curette, angled up, total length 190mm
Cureta seno maxilar, angulado hacia arriba, longitud total 190mm
Curette sinus maxillaire, angulée vers le haut, longueur totale 190mm

- 441-207** klein rund / small round
pequena, redonda / petite, ronde
441-208 längsoval klein / oblong small
pequena, oval al largo / petite, ovale dir. longitudinale
441-209 längsoval groß / oblong large
grande, oval al largo / grande, ovale dir. longitudinale



Stirnhöhlenlöffel, Gesamtlänge 190mm
Frontal sinus curette, total length 190mm
Cureta sinus frontal, longitud total 190mm
Curette sinus frontal, longueur totale 190mm

- 441-213** längsoval, 55° aufgebogen / oblong, 55° curved up
oval al largo, 55° curva arriba /
ovale dir. longitudinale, 55° courbée vers le haut
441-214 längsoval, 90° aufgebogen / oblong, 90° curved up
oval al largo, 90° curva arriba /
ovale dir. longitudinale, 90° courbée vers le haut

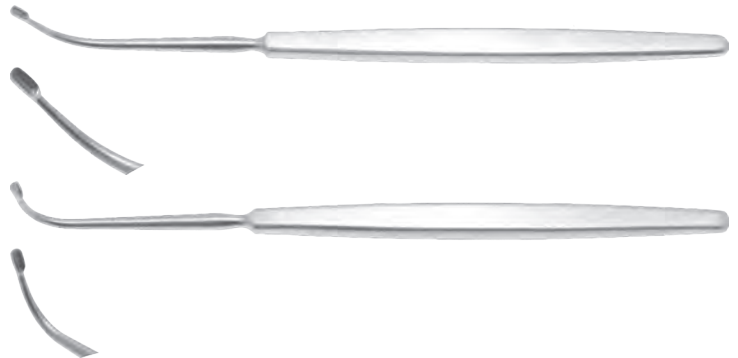

Kieferhöhlen Kürette, Gesamtlänge 190mm
Antrum curette, total length 190mm
Cureta seno maxilar, longitud total 190mm
Curette sinus maxillaire, longueur totale 190mm

- 441-215-01** klein, vorwärts schneidend / small, forward cutting
pequena, cortante adelante / petit, coupant en avant
441-215-02 groß, vorwärts schneidend / large, forward cutting
grande, cortante adelante / grand, coupant en avant
441-216-01 klein, rückwärts schneidend / small, backward cutting
pequena, cortante atrás / petit, coupant en arrière
441-216-02 groß, rückwärts schneidend / large, backward cutting
grande, cortante atrás / grand, coupant en arrière

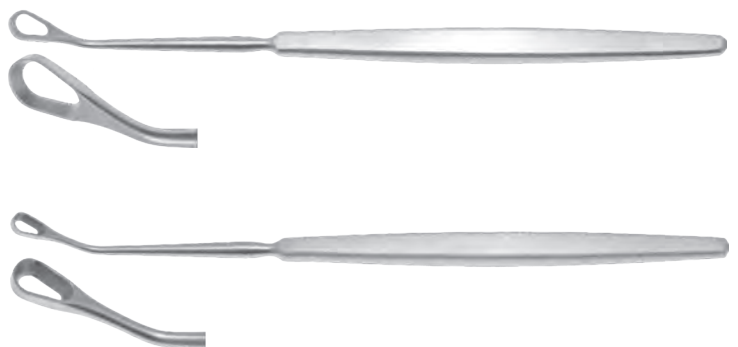

HALLE

Kieferhöhlenlöffel, biegsamer Schaft, Gesamtlänge 210mm
Antrum curette, malleable shaft, total length 210mm
Cureta seno maxilar, mango maleable, longitud total 210mm
Curette sinus maxillaire, tige malléable, longueur totale 210mm

- 441-270** Fig. 1
441-271 Fig. 2
441-272 Fig. 3



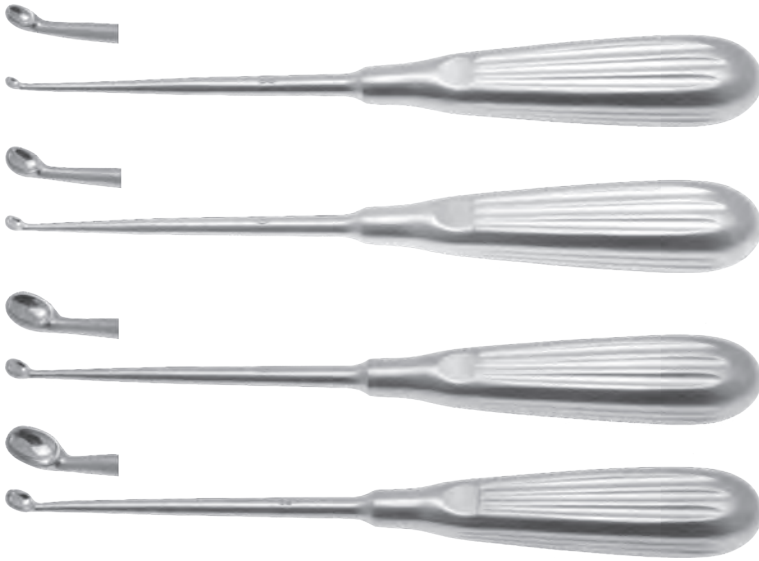

DAUBENSPECK

Kieferhöhlenlöffel, aufgewinkelt Gesamtlänge 200mm
Antrum currettes, angled up, total length 200mm
Cureta sino maxilar, angulada arriba, longitud total 200mm
Curette pour sinus maxillaire, angulée vers le haut, longueur totale 200mm

441-280	Fig. 00
441-281	Fig. 0
441-282	Fig. 1
441-283	Fig. 2



FAULKNER

Kieferhöhlen-Kürette, doppelseitig, Gesamtlänge 210mm
Antrum curette, double ended, total length 210mm
Cureta seno maxilar, doble, longitud total 210mm
Curette sinus maxillaire, double, longueur totale 210mm

441-220

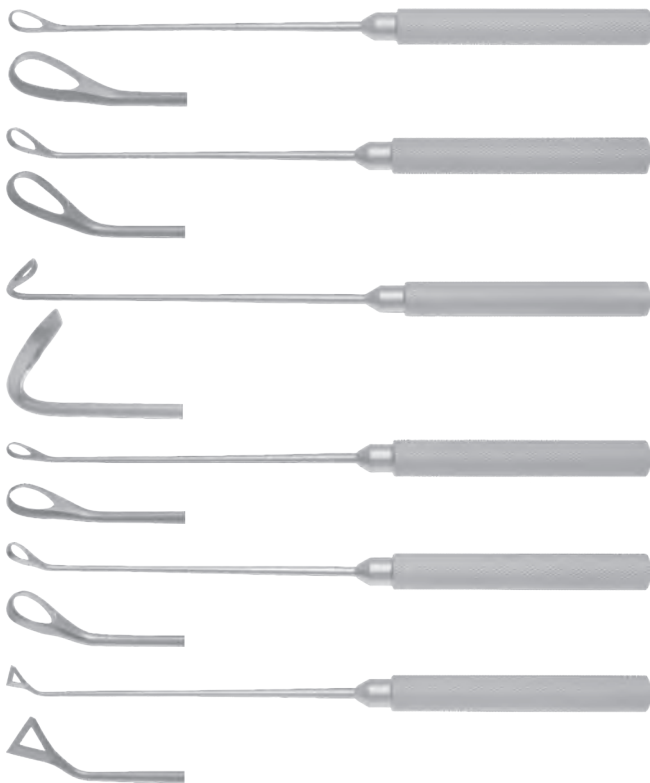

COAKLEY

Kieferhöhlen-Kürette, biegsamer Schaft, Gesamtlänge 170mm
Antrum curette, malleable shaft, total length 170mm
Cureta seno maxilar, mango maleable, longitud total 170mm
Curette sinus maxillaire, tige malléable, longueur totale 170mm

441-241	Fig. 1
441-242	Fig. 2
441-243	Fig. 3
441-244	Fig. 4
441-245	Fig. 5
441-246	Fig. 6



Sichelmesser, 190mm
Sickle knife, 190mm
Cuchillo de hoz, 190mm
Faux tige, 190mm

440-404	spitz / pointed agudo / pointue
440-406	abgerundet / rounded redondeado / arrondie

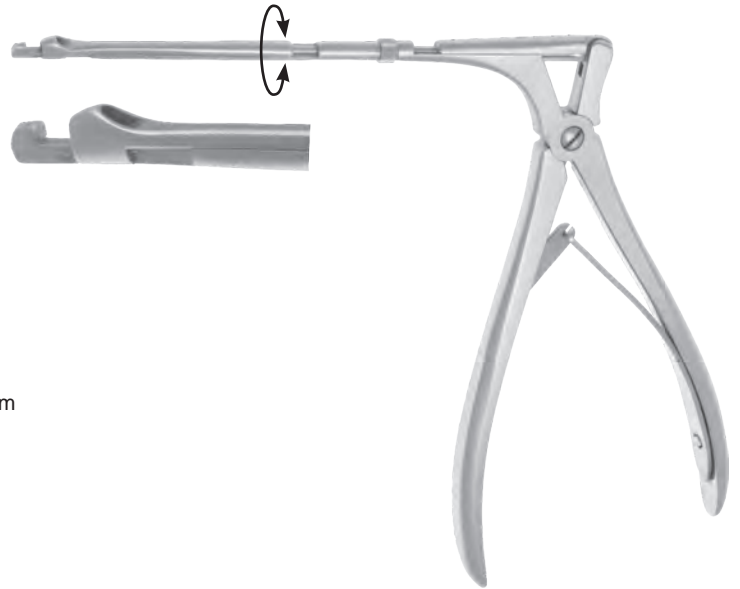

MC KENTY

Keilbeinstanze, 360° drehbar, Arbeitslänge 120mm
Sphenoid punch, 360° rotatable, working length 120mm
Punzonadora esfenoïdes, rotatable 360°, longitud de trabajo 120mm
Pince emporte-pièce sinus sphénoïdal, pivotable 360°, long.travail 120mm

441-836 2,0mm breit / 2,0mm wide
anchura 2,0mm / largeur 2,0mm

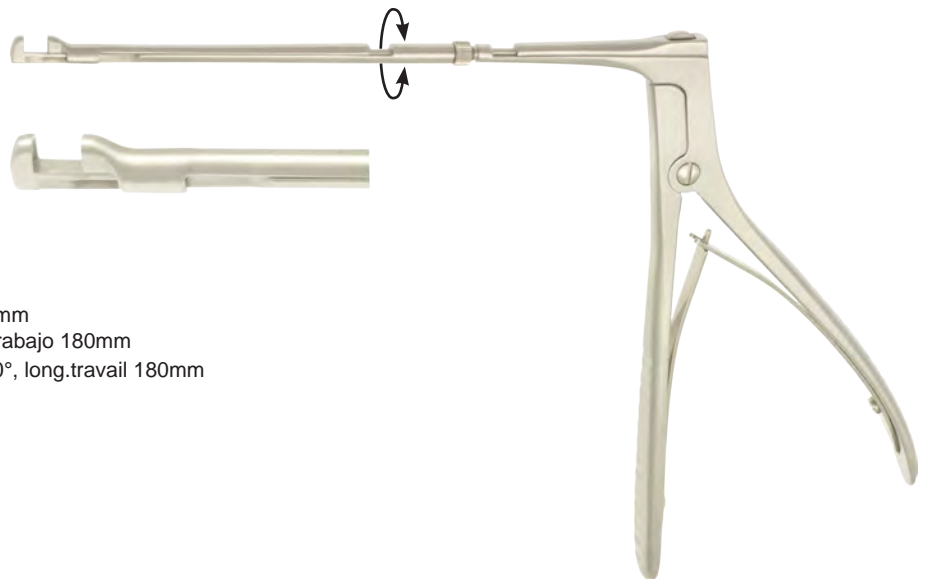

HAJEK-KOFLER

Keilbeinstanze, 360° drehbar, Arbeitslänge 180mm
Sphenoid punch, 360° rotatable, working length 180mm
Punzonadora esfenoïdes, rotatable 360°, longitud de trabajo 180mm
Pince emporte-pièce sinus sphénoïdal, pivotable 360°, long.travail 180mm

441-839 3,2mm breit / 3,2mm wide
anchura 3,2mm / largeur 3,2mm



BEYER

Kieferhöhlenstanze, 90° nach oben schneidend, Arbeitslänge 90mm
Antrum punch, 90° upbiting, working length 90mm
Punzonadora seno maxilar, 90° cortante arriba, longit. de trabajo 90mm
Pince emporte-pièce sinus maxillaire, coupe 90° vers le haut, longueur de travail 90mm

441-870-01 1,0mm breit / 1,0mm wide
anchura 1,0mm / largeur 1,0mm /

441-870-02 2,0mm breit / 2,0mm wide
anchura 2,0mm / largeur 2,0mm



HAJEK-KOFLER

Keilbeinstanze, 90° nach oben schneidend, Arbeitslänge 140mm
Sphenoid punch, 90° upbiting, working length 140mm
Punzonadora esfenoides, 90° cortante arriba, longit. de trabajo 140mm
Pince emporte-pièce sinus sphénoïdal, coupe 90° vers le haut, longueur de travail 140mm

441-881 3,5mm breit / 3,5mm wide
anchura 3,5mm / largeur 3,5mm

441-882 4,0mm breit / 4,0mm wide
anchura 4,0mm / largeur 4,0mm



HAJEK-KOFLER

Keilbeinstanze, 90° nach unten schneidend, Arbeitslänge 140mm
Sphenoid punch, 90° downbiting, working length 140mm
Punzonadora esfenoides, 90° cortante abajo, longit. de trabajo 140mm
Pince emporte-pièce sinus sphénoïdal, coupe 90° vers le bas, longueur de travail 140mm

441-891 3,5mm breit / 3,5mm wide
anchura 3,5mm / largeur 3,5mm

441-892 4,0mm breit / 4,0mm wide
anchura 4,0mm / largeur 4,0mm

KERRISON

Knochenstanze, 90° aufwärts, Arbeitslänge 180mm
Bone punch, 90° upwards, working length 180mm
Punzonadora de hueso, 90° hacia arriba, longitud de trabajo 180mm
Pince emporte-pièce d'os, 90° vers le haut, long. de travail 180mm

- 344-011** Ausschnitt 1mm / bite 1mm
recorte 1mm / découpe 1mm
- 344-012** Ausschnitt 2mm / bite 2mm
recorte 2mm / découpe 2mm
- 344-013** Ausschnitt 3mm / bite 3mm
recorte 3mm / découpe 3mm
- 344-014** Ausschnitt 4mm / bite 4mm
recorte 4mm / découpe 4mm
- 344-015** Ausschnitt 5mm / bite 5mm
recorte 5mm / découpe 5mm



KERRISON

Knochenstanze, 90° abwärts, Arbeitslänge 180mm
Bone punch, 90° downwards, working length 180mm
Punzonadora de hueso, 90° hacia abajo, longitud de trabajo 180mm
Pince emporte-pièce d'os, 90° vers le bas, long. de travail 180mm

- 344-041** Ausschnitt 1mm / bite 1mm
recorte 1mm / découpe 1mm
- 344-042** Ausschnitt 2mm / bite 2mm
recorte 2mm / découpe 2mm
- 344-043** Ausschnitt 3mm / bite 3mm
recorte 3mm / découpe 3mm
- 344-044** Ausschnitt 4mm / bite 4mm
recorte 4mm / découpe 4mm
- 344-045** Ausschnitt 5mm / bite 5mm
recorte 5mm / découpe 5mm



KERRISON

Knochenstanze, 40° aufwärts, Arbeitslänge 180mm
Bone punch, 40° upwards, working length 180mm
Punzonadora de hueso, 40° hacia arriba, longitud de trabajo 180mm
Pince emporte-pièce d'os, 40° vers le haut, long. de travail 180mm

- 344-141** Ausschnitt 1mm / bite 1mm
recorte 1mm / découpe 1mm
- 344-142** Ausschnitt 2mm / bite 2mm
recorte 2mm / découpe 2mm
- 344-143** Ausschnitt 3mm / bite 3mm
recorte 3mm / découpe 3mm
- 344-144** Ausschnitt 4mm / bite 4mm
recorte 4mm / découpe 4mm
- 344-145** Ausschnitt 5mm / bite 5mm
recorte 5mm / découpe 5mm



KERRISON

Knochenstanze, 40° abwärts, Arbeitslänge 180mm
Bone punch, 40° downwards, working length 180mm
Punzonadora de hueso, 40° hacia abajo, longitud de trabajo 180mm
Pince emporte-pièce d'os, 40° vers le bas, long. de travail 180mm

- 344-071** Ausschnitt 1mm / bite 1mm
recorte 1mm / découpe 1mm
- 344-072** Ausschnitt 2mm / bite 2mm
recorte 2mm / découpe 2mm
- 344-073** Ausschnitt 3mm / bite 3mm
recorte 3mm / découpe 3mm
- 344-074** Ausschnitt 4mm / bite 4mm
recorte 4mm / découpe 4mm
- 344-075** Ausschnitt 5mm / bite 5mm
recorte 5mm / découpe 5mm





STAMMBERGER

Kieferhöhlenstanze, Ausschnitt 2,5mm, Arbeitslänge 100mm
Antrum punch, bite 2,5mm, working length 100mm
Punzonadora seno maxilar, recorte 2,5mm,
longitud de trabajo 100mm
Pince emporte-pièce sinus maxillaire, découpe 2,5mm,
longueur de travail 100mm

- 443-710** nach oben rückwärts schneidend
upside backwards cutting
cortante arriba atrás
coupe rétrograde vers le haut
- 443-710L** nach links rückwärts schneidend
left backwards cutting
cortante iziquieda atrás
coupe rétrograde vers la gauche
- 443-710R** nach rechts rückwärts schneidend
right backwards cutting
cortante derecha atrás
coupe rétrograde vers la droite



STAMMBERGER

Kieferhöhlenstanze, Ausschnitt 1,5mm, Arbeitslänge 100mm
Antrum punch, bite 1,5mm, working length 100mm
Punzonadora seno maxilar, recorte 1,5mm,
longitud de trabajo 100mm
Pince emporte-pièce sinus maxillaire, découpe 1,5mm,
longueur de travail 100mm

- 443-712** nach oben rückwärts schneidend
upside backwards cutting
cortante arriba atrás
coupe rétrograde vers le haut
- 443-712L** nach links rückwärts schneidend
left backwards cutting
cortante iziquieda atrás
coupe rétrograde vers la gauche
- 443-712R** nach rechts rückwärts schneidend
right backwards cutting
cortante derecha atrás /
coupe rétrograde vers la droite

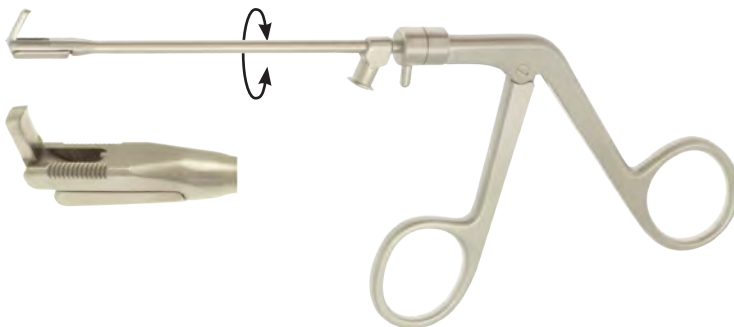

STAMMBERGER

Kieferhöhlenstanze, 360° drehbar, rückwärts schneidend,
Arbeitslänge 100mm
Antrum punch, 360° rotatable, backwards cutting, working
length 100mm
Punzonadora seno maxilar, 360° rotatable, cortante atrás,
longitud de trabajo 100mm
Pince emporte-pièce antré, pivotable 360°, coupe rétrograde,
longueur de travail 100mm

- 443-720** Ausschnitt 2,5mm / bite 2,5mm
recorte 2,5mm / découpe 2,5mm
- 443-722** Ausschnitt 1,5mm / bite 1,5mm
recorte 1,5mm / découpe 1,5mm

TOBEY

Kieferhöhlenstanze, 360° drehbar, rückwärts schneidend, leicht gebogen, Arbeitslänge 100mm
Antrum punch, 360° rotatable, backwards cutting, slightly curved, working length 100mm
Punzonadora de seno maxilar, 360° rotatable, cortante atrás, curva ligera, longitud de trabajo 100mm
Pince emporte-pièce sinus maxillaire, pivotable 360°, coupe rétrograde, courbure légère, longueur de travail 100mm

443-725 Ausschnitt 2,0mm / bite 2,0mm
recorte 2,0mm / découpe 2,0mm

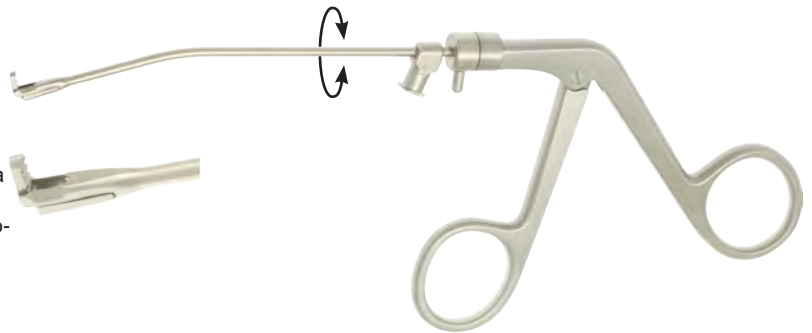

STAMMBERGER

Kieferhöhlenstanze, durchschneidend, Arbeitslänge 100mm
Antrum punch, through-cutting, working length 100mm
Punzonadora de seno maxilar, cortante, longitud de trabajo 100mm
Pince emporte-pièce sinus maxillaire, tranchante, longueur de travail 100mm

443-719L seitwärts nach links unten schneidend,
leftside downward cutting,
cortante abajo a la izquierda
coupe latérale, vers le bas gauche

443-719R seitwärts nach rechts unten schneidend,
rightside downward cutting,
cortante abajo a la derecha
coupe latérale, vers le bas droite



STRUYKEN

Conchotom, durchschneidend, Arbeitslänge 135mm
Conchotome, through-cutting, working length 135mm
Conchotom, cortante, longitud de trabajo 135mm
Conchotom, tranchante, longueur de travail 135mm

443-531-10 Ausschnitt 1,0x12mm, bite 1,0x12mm,
recorte 1,0x12mm, découpe 1,0x12mm

443-531-15 Ausschnitt 1,5x12mm, bite 1,5x12mm,
recorte 1,5x12mm, découpe 1,5x12mm

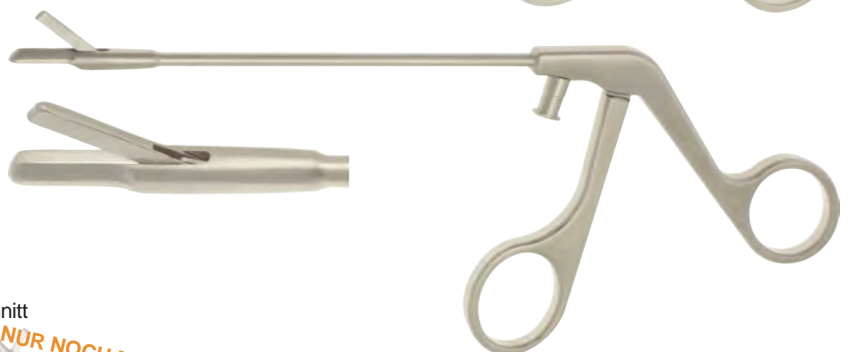

Nasenzange, durchschneidend mit gezahntem Maulteil, Ausschnitt 2,0mm, 65° aufgebogen, Arbeitslänge 160mm
Nasal Forceps, through cutting with serrated jaw, bite 2,0 mm, 65° upturned, working length 160mm
Pinza nasal, cortante con boca estriada, recorte 2,0mm, 65° curva arriba, longitud de trabajo 160mm
Pince nasale, trachante avec mors striés, découpe 2,0mm, 65° courbée vers le haut, longueur de travail 160mm

443-739 vertikal öffnend, vertical opening,
apertura vertical, ouverture verticale

443-739L links öffnend, opening to the left,
apertura hacia la izquierda, ouverture vers la gauche

443-739R rechts öffnend, opening to the right,
apertura hacia la derecha, ouverture vers la droite

**NUR NOCH MIT SPÜLANSCHLUSS (LUER-LOCK) FÜR DIE REINIGUNG LIEFERBAR
ABBILDUNGEN FOLGEN**

**ONLY AVAILABLE WITH RINSING CONNECTION (LUER-LOCK) FOR CLEANING
PICTURE WILL FOLLOW SOON**

**SEULEMENT DISPONIBLE AVEC RACCORD RE RINCAGE (LUER-LOCK) POUR LE NETTOYAGE
IMAGES SUIVront**



BLAKESLEY

Nasenzange, gerade, Arbeitslänge 130mm
Nasal forceps, straight, working length 130mm
Pinza nasal, recta, longitud de trabajo 130mm
Pince nasale, droite, longueur de travail 130mm

443-750-25 2,5mm
443-750-30 3,0mm
443-750-35 3,5mm
443-750-40 4,0mm
443-750-50 5,0mm



BLAKESLEY

Nasenzange, 45° aufgebogen, Arbeitslänge 130mm
Nasal forceps, 45° curved up, working length 130mm
Pinza nasal, 45° curva hacia arriba, longitud de trabajo 130mm
Pince nasale, 45° courbée vers le haut, long.de travail 130mm

443-751-25 2,5mm
443-751-30 3,0mm
443-751-35 3,5mm
443-751-40 4,0mm



BLAKESLEY

Nasenzange, 90° aufgebogen, Arbeitslänge 130mm
Nasal forceps, 90° curved up, working length 130mm
Pinza nasal, 90° curva hacia arriba, longitud de trabajo 130mm
Pince nasale, 90° courbée vers le haut, long.de travail 130mm

443-753-35 3,5mm
443-753-40 4,0mm



BLAKESLEY

Nasenzange, durchschneidend, gerade, Arbeitslänge 130mm
Nasal forceps, through-cutting, straight, working length 130mm
Pinza nasal, cortante, recta, longitud de trabajo 130mm
Pince nasale, tranchante, droite, longueur de travail 130mm

443-760-26 2,6mm
443-760-36 3,6mm
443-760-42 4,2mm



BLAKESLEY

Nasenzange, durchschneidend 45° aufgebogen,
Arbeitslänge 130mm
Nasal forceps, through-cutting, 45° curved up,
working length 130mm
Pinza nasal, cortante, 45° curva hacia arriba, longitud de trabajo 130mm
Pince nasale, tranchante, 45° courbée vers le haut,
longueur de travail 130mm

443-761-26 2,6mm
443-761-36 3,6mm
443-761-42 4,2mm

Giraffenzange, 55° aufgebogen, doppelbeweglicher Löffel
Giraffe forceps, 55° upturned, double action cup
Pinza jirafa, 55° curva hacia arriba, cuchara de doble acción
Pince girafe, 55° courbée vers le haut, cuillère double-action

444-2210-20 Ø 2mm, vertikal öffnend
Ø 2mm, vertical opening
Ø 2mm, apertura vertical
Ø 2mm, ouverture verticale

444-2210-30 Ø 3mm, vertikal öffnend
Ø 3mm, vertical opening
Ø 3mm, apertura vertical
Ø 3mm, ouverture verticale

444-2210-40 Ø 4mm, vertikal öffnend
Ø 4mm, vertical opening
Ø 4mm, apertura vertical
Ø 4mm, ouverture verticale

444-2211-20 Ø 2mm, horizontal öffnend
Ø 2mm, horizontal opening
Ø 2mm, apertura horizontal
Ø 2mm, ouverture horizontale

444-2211-30 Ø 3mm, horizontal öffnend
Ø 3mm, horizontal opening
Ø 3mm, apertura horizontal
Ø 3mm, ouverture horizontale

444-2211-40 Ø 4mm, horizontal öffnend
Ø 4mm, horizontal opening
Ø 4mm, apertura horizontal
Ø 4mm, ouverture horizontale



Giraffenzange, 90° aufgebogen, doppelbeweglicher Löffel
Giraffe forceps, 90° upturned, double action cup
Pinza jirafa, 90° curva hacia arriba, cuchara de doble acción
Pince girafe, 90° courbée vers le haut, cuillère double-action

444-2214-20 Ø 2mm, vertikal öffnend
Ø 2mm, vertical opening
Ø 2mm, apertura vertical
Ø 2mm, ouverture verticale

444-2214-40 Ø 4mm, vertikal öffnend
Ø 4mm, vertical opening
Ø 4mm, apertura vertical
Ø 4mm, ouverture verticale

444-2215-20 Ø 2mm, horizontal öffnend
Ø 2mm, horizontal opening
Ø 2mm, apertura horizontal
Ø 2mm, ouverture horizontale

444-2215-40 Ø 4mm, horizontal öffnend
Ø 4mm, horizontal opening
Ø 4mm, apertura horizontal
Ø 4mm, ouverture horizontale





Löffelzange, 70° aufgebogen, doppelbeweglicher ovaler Löffel
Biopsy forceps, 70° upturned, double action oval cup
Pinza de biopsia, 70° curva arriba, cuchara ovalada de doble acción
Pince à biopsie, courbée vers le haut 70°, cuillère ovale double-action

444-2212-26 Ø 2,6mm, vertikal öffnend
Ø 2,6mm, vertical opening
Ø 2,6mm, apertura vertical
Ø 2,6mm, ouverture verticale

444-2212-40 Ø 4mm, vertikal öffnend
Ø 4mm, vertical opening
Ø 4mm, apertura vertical
Ø 4mm, ouverture verticale



444-2213-26 Ø 2,6mm, horizontal öffnend
Ø 2,6mm, horizontal opening
Ø 2,6mm, apertura horizontal
Ø 2,6mm, ouverture horizontale

444-2213-40 Ø 4mm, horizontal öffnend
Ø 4mm, horizontal opening
Ø 4mm, apertura horizontal
Ø 4mm, ouverture horizontale



Löffelzange, 110° aufgebogen, doppelbeweglicher ovaler Löffel
Biopsy forceps, 110° upturned, double action oval cup
Pinzas de biopsia, 110° curva hacia arriba, curchara ovalada de doble acción
Pince à biopsie, 110° courbée vers le haut, cuillère ovale double-action

444-2216-26 Ø 2,6mm, vertikal öffnend
Ø 2,6mm, vertical opening
Ø 2,6mm, apertura vertical
Ø 2,6mm, ouverture verticale

444-2216-40 Ø 4mm, vertikal öffnend
Ø 4mm, vertical opening
Ø 4mm, apertura vertical
Ø 4mm, ouverture verticale



444-2217-26 Ø 2,6mm, horizontal öffnend
Ø 2,6mm, horizontal opening
Ø 2,6mm, apertura horizontal
Ø 2,6mm, ouverture horizontale

444-2217-40 Ø 4mm, horizontal öffnend
Ø 4mm, horizontal opening
Ø 4mm, apertura horizontal
Ø 4mm, ouverture horizontale

STAMMBERGER

Löffelzange, 65° aufgebogen, doppelbeweglicher Löffel
 Biopsy forceps, 65° upturned, double action oval cup
 Pinza de biopsia, 65° curva arriba, cuchara de doble acción
 Pince à biopsie, 65° courbée vers le haut, cuillère double-action

- 444-2225** Ø 3,0mm, vertikal öffnend
 Ø 3,0mm, vertical opening
 Ø 3,0mm, apertura vertical
 Ø 3,0mm, ouverture verticale
- 444-2226** Ø 3,0mm, horizontal öffnend
 Ø 3,0mm, horizontal opening
 Ø 3,0mm, apertura horizontal
 Ø 3,0mm ouverture horizontale



Kieferhöhlen-Fasszange, bewegliches Maulteil 120° rückwärts
 öffnend, Arbeitslänge 100mm
 Antrum grasping forceps, moveable jaw backwards opening 120°,
 working length 100mm
 Pinza de aprehension seno maxilar, boca movil 120°, apertura
 atrás, longitud de trabajo 100mm
 Pince sinus maxillaire, mors mobile 120°, ouverture rétrograde,
 longueur.de travail 100mm

- 444-2200** 90° abwärts gebogen, 90° curved downwards
 90° curva abajo, courbée 90° bas
- 444-2201** 90° aufwärts gebogen, 90° curved upwards
 90° curva arriba, courbée 90° haut



Kiefernhöhlen-Fasszange, 360° drehbar, bewegliches
 Maulteil 120° rückwärts öffnend, Arbeitslänge 100mm
 Antrum grasping forceps, 360° rotatable, moveable jaw backwards
 opening 120°, working length 100mm
 Pinza de aprehension seno maxilar, 360° rotatable, boca
 movil 120° apertura atrás, longitud de trabajo 100mm
 Pince sinus maxillaire, pivotable 360°, mors mobile 120°
 ouverture rétrograde, longueur.de travail 100mm

- 444-2210**

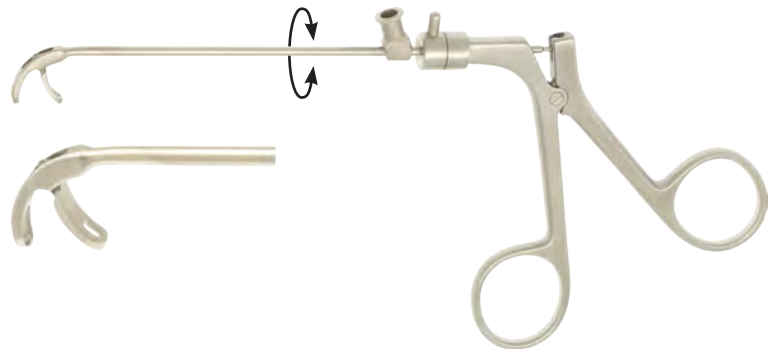



Rundkopfstanze, 360° zirkulär schneidend, Arbeitslänge 180mm
Circular cutting punch, cutting in full circle 360°,
working length 180mm
Punzonadora cabeza redonda, cortante circular 360°,
longitud trabajo 180mm
Pince emporte-pièce tête circulaire, coupe circulaire 360°,
longueur de travail 180mm

444-2300-35 Ø 3,5mm
444-2300-45 Ø 4,5mm



Rundkopfstanze, 360° zirkulär schneidend, 65° aufgebogen,
Arbeitslänge 180mm
Circular cutting punch, cutting in full circle 360°, 65° upturned,
working length 180mm
Punzonadora cabeza redonda, cortante ciruc. 360°,
65° curva arriba, longitud de trabajo 180mm
Pince emporte-pièce tête circulaire, coupe 360°,
courbée vers le haut 65°, longueur de travail 180mm

444-2301-35 Ø 3,5mm
444-2301-45 Ø 4,5mm

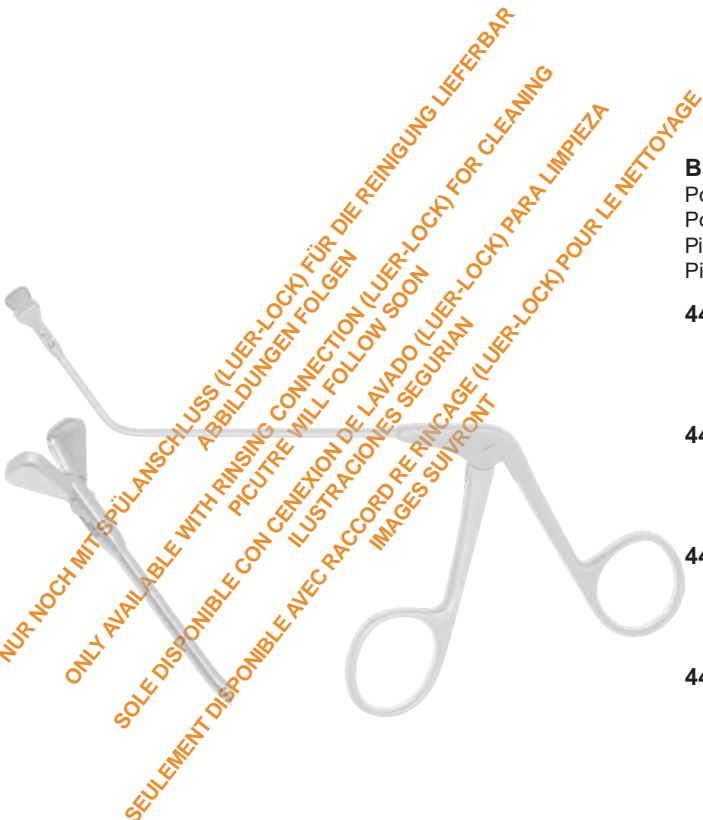

BINNER

Polypenfasszange, birnenförmiges Maulteil 3x1,5mm, horizontal öffnend
Polyp grasping forceps, pear shaped jaws 3x1,5mm, horizontal opening
Pinza de aprehension polipo, boca forma de pera 3x1,5mm, apertura horizontal
Pince préhension polypes, mors forme poire 3x1,5mm, ouverture horizontale

444-2227 80° aufgebogen
80° upturned
80° curva hacia arriba
80° courbée vers le haut

444-2227L 80° nach links gebogen
80° curved left
80° curva hacia izquierda
80° courbée vers la gauche

444-2227R 80° nach rechts gebogen
80° curved right
80° curva hacia derecha
80° courbée droite

444-2228 45° aufgebogen
45° upturned
45° curva hacia arriba
45° courbée vers le haut

**STIRNHÖHLENSTANZE
FRONTAL SINUS PUNCH
PUNZONADORA SENO FRONTAL
PINCE EMPORTE-PIECE SINUS FRONTAL**

ELCON
HNO - ENT - ORL

Stirnhöhlenzange, durchschneidend, 55° aufgebogen, Arbeitslänge 145mm
Frontal sinus forceps, through cutting, 55° upturned, working length 145mm
Fórceps de seno frontal, tranchante, 55° curva hacia arriba, longitud de trabajo 145mm
Pince sinus frontal, tranchante, 55° courbée vers le haut, longueur de travail 145mm

- 444-2261** Ø 2,0mm, vertikal öffnend
Ø 2,0mm, vertical opening
Ø 2,0mm, apertura vertical
Ø 2,0mm, ouverture verticale
- 444-2263** Ø 2,0mm, horizontal öffnend
Ø 2,0mm, horizontal opening
Ø 2,0mm, apertura horizontal
Ø 2,0mm, ouverture horizontale



Stirnhöhlenzange, durchschneidend, 90° aufgebogen, Arbeitslänge 145mm
Frontal sinus forceps, through cutting, 90° upturned, working length 145mm
Fórceps de seno frontal, tranchante, 90° curva hacia arriba, longitud de trabajo 145mm
Pince sinus frontal, tranchante, 90° courbée vers le haut, longueur de travail 145mm

- 444-2265** Ø 2,0mm, vertikal öffnend
Ø 2,0mm, vertical opening
Ø 2,0mm, apertura vertical
Ø 2,0mm, ouverture verticale
- 444-2267** Ø 2,0mm, horizontal öffnend
Ø 2,0mm, horizontal opening
Ø 2,0mm, apertura horizontal
Ø 2,0mm, ouverture horizontale



Stirnhöhlenstanze, 70° aufgebogen, Arbeitslänge 175mm
Frontal sinus punch, 70° upturned, working length 175mm
Punzonadora seno frontal, 70° curva hacia arriba, longitud de trabajo 175mm
Pince emporte-pièce sinus frontal, 70° courbée vers le haut, longueur de travail 175mm

- 444-0280-30** 3,0mm, 40° noch oben schneidend
3,0mm, 40° upbiting
3,0mm, 40° cortante hacia arriba
3,0mm, coupe 40° vers le haut

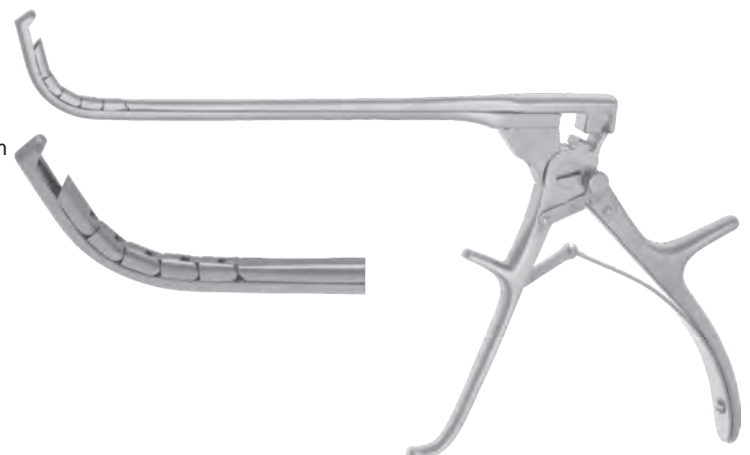



WIEDER

Zungendrucker, Gesamtlänge 140mm
Tongue depressor, total length 140mm
Abaja lenguas, longitud total 140mm
Abaisse-langue, longueur totale 140mm

470-424 Breite 29mm, width 29mm,
anchura 29mm, largeur 29mm

470-425 Breite 35mm, width 35mm,
anchura 35mm, largeur 35mm



HARTMANN

Zungendrucker
Tongue depressor
Abaja lenguas
Abaisse-langue

470-426 150mm



TOBOLD

Zungendrucker
Tongue depressor
Abaja lenguas
Abaisse-langue

470-427 150mm



Zungendrucker, S-gebogen, Gesamtlänge 145mm
Tongue depressor, s-curved, total length 145mm
Abaja lenguas, curva-S, longitud total 145mm
Abaisse-langue, courbé en S, longueur totale 145mm

470-440 17,5mm



BUCHWALD

Zungendrucker, S-gebogen, Gesamtlänge 180mm
Tongue depressor, s-curved, total length 180mm
Abaja lenguas, curva-S longitud total 180mm
Abaisse-langue, courbé en S, longueur totale 180mm

470-445 18/23mm



BRUENINGS

Zungendrucker, S-gebogen, Gesamtlänge 190mm
Tongue depressor, s-curved, total length 190mm
Abaja lenguas, curva-S, longitud total 190mm
Abaisse-langue, courbé en S, longueur totale 190mm

470-446



MORITZ-SCHMIDT

Zungendrucker
Tongue depressor
Abaja lenguas
Abaisse-langue

470-460 190mm

MOLT
Mundsperrer
Mouth gag
Abre boca
Ouvre-bouche

470-102 115mm
470-103 140mm



JENNINGS
Mundsperrer
Mouth gag
Abre boca
Ouvre-bouche

470-130 90mm
470-131 110mm
470-132 130mm
470-133 150mm

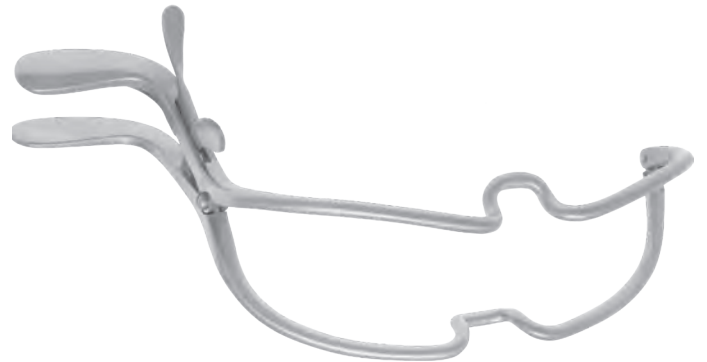



MC IVOR

Mundsperrer, Halter alleine
Mouth gag, frame only
Abre boca, cuadro solo
Ouvre-bouche, cadre seul

470-201



DAVIS-BOYLE

Mundsperrer, Halter alleine, für Kinder
Mouth gag, frame only, for children
Abre boca, cuadro solo, para niños
Ouvre-bouche, cadre seul, pour enfants

470-211



DAVIS-BOYLE

Mundsperrer, Halter alleine, für Erwachsene
Mouth gag, frame only, for adults
Abre boca, cuadro solo, para adultos
Ouvre-bouche, cadre seul, pour adultes

470-221



DAVIS-MEYER

Mundsperrer, Halter alleine, 2 verschiebbar Zahnhaltern
Mouth gag, frame only, 2 movable tooth hooks
Abre boca, cuadro solo, 2 soportes de dientes móviles
Ouvre-bouche, cadre seul, 2 crochets fixe-dents ajustables

470-271

MUNDSPERRER
MOUTH GAG
ABRE BOCA
OUVRE-BOUCHE

ELCON
HNO - ENT - ORL

DINGMANN

Mundsperrer, Halter alleine, mit 2 drehbaren Wangenhaltern, 2 verschiebbare Zahnhaltern und Fadenführer
Mouth gag, frame only, with 2 movable cheek holders, 2 moveble tooth hooks and thread guide
Abre boca, cuadro solo, 2 soportes de mejillas rotables, 2 soportes de dientes moviles y guia de hilo
Ouvre-bouche, cadre seul, avec 2 fixes-joues rotatifs, 2 crochets fixe-dents ajustables et guide de fils

470-301



KILNER-DOUGHTY

Mundsperrer, Halter alleine, 2 verschiebbare Zahnhalter
Mouth gag, frame only, 2 movable tooth hooks
Abre boca, cuadro solo, 2 soportes de dientes moviles
Ouvre-bouche, cadre seul, 2 crochets fixe-dents ajustables

470-341





MC IVOR

Zungendrücken
Tongue depressor
Abaja lenguas
Abaisse-langue

470-200-01	70x23mm
470-200-02	85x25mm
470-200-03	100x26mm



DAVIS-BOYLE

Zungendrücken
Tongue depressor
Abaja lenguas
Abaisse-langue

470-210-01	30x20mm
-------------------	---------



DAVIS-BOYLE

Zungendrücken
Tongue depressor
Abaja lenguas
Abaisse-langue

470-210-02	45x19mm
470-210-03	65x23mm
470-210-04	70x22mm
470-210-05	80x24mm
470-210-06	93x25mm
470-210-07	108x25mm



WUERZBURG

Zungendrücken
Tongue depressor
Abaja lenguas
Abaisse-langue

470-261-01	66x28mm
470-261-02	75x32mm
470-261-03	83x34mm
470-261-04	93x37mm
470-261-05	100x38mm



DAVIS-MEYER

Zungendrücken, mit beidseitigem Narkoserohr
Tongue depressor, with anaesthetic channel on both sides
Abaja lenguas, con tubo de la anestesia en doble lado
Abaisse-langue, avec tube d'anesthésie sur les deux côtés

470-270-01	70x29mm
470-270-02	75x31mm
470-270-03	80x32mm
470-270-04	85x32mm
470-270-05	95x33mm
470-270-06	100x34mm
470-270-07	105x34mm

ZUNGENDRÜCKER FÜR MUNDSPERRER
TONGUE DEPRESSOR FOR MOUTH GAG
ABAJA LENGUAS PARA ABRE BOCAS
ABAISSE-LANGUE POUR OUVRE-BOUCHE

ELCON
HNO - ENT - ORL



DINGMANN

Zungendrucker, mit Tubusrinne
Tongue depressor, with central channel
Abaja lenguas, con canal para tubo
Abaisse-langue, avec rainure pour tubus

470-302	62x24mm
470-303	65x28mm
470-304	75x31mm



RING

Zungendrucker
Tongue depressor
Abaja lenguas
Abaisse-langue

470-362-01L	58x23mm
470-362-02L	72x27mm
470-362-03L	87x34mm
470-362-04L	95x37mm



RING

Zungendrucker
Tongue depressor
Abaja lenguas
Abaisse-langue

470-363-01R	58x23mm
470-363-02R	72x27mm
470-363-03R	87x34mm
470-363-04R	95x37mm



RUSSEL-DAVIS

Zungendrucker, mit Tubusrinne
Tongue depressor, with central channel
Abaja lenguas, con canal para tubo
Abaisse-langue, avec rainure pour tubus

470-371	65x28mm
470-372	75x32mm
470-373	80x37mm
470-374	94x41mm
470-375	103x46mm



NEGUS

Bruststütze
Chest support
Apoyo de pecho
Appui poitrine

470-390 140mm

470-392 85mm

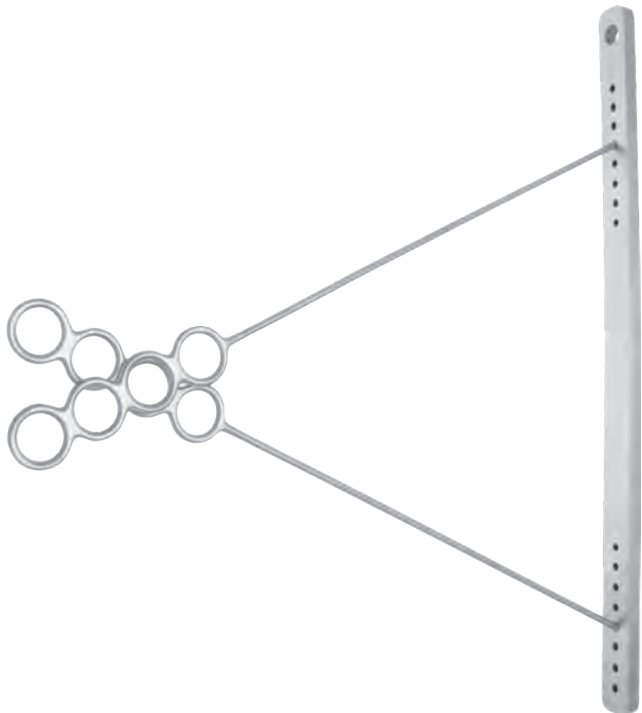

DRAFFIN

Mundsperrer-Aufhängung
Bipod suspension for mouth gag
Suspension para abre boca
Suspension ouvre-bouche

470-396-04

bestehend aus / consisting of
compuesto de / composé de

470-397 Grundplatte zum Befestigen des Draffin Rahmens
Base plate for holding Draffin bipod

Placa de base para fijar el cuadro Draffin

Plaque de base pour fixer le cadre Draffin

470-399-04 2x Stützstangen mit 4 Ringen
2x bipod with 4 rings

2x Barras de soporte con 4 anillos

2x Barre de support avec 4 anneaux

COLVER

Tonsillenfasszange, Gesamtlänge 190mm
Tonsil forceps, total length 190mm
Pinza de aprehension amigdalas, longitud total 190mm
Pince préhension amygdales, longueur totale 190mm

470-500 gerade, straight, recta, droite
470-501 gebogen, curved, curva, courbée



BALLENGER

Tonsillenfasszange, Gesamtlänge 220mm
Tonsil forceps, total length 220mm
Pinza de aprehension amigdalas, longitud total 220mm
Pince préhension amygdales, longueur totale 220mm

470-503



WHITE

Tonsillenfasszange
Tonsil forceps
Pinza de aprehension amigdalas
Pince préhension amygdales

470-505 180mm
470-507 230mm



BLOHMKE

Tonsillenfasszange, Gesamtlänge 200mm
Tonsil forceps, total length 200mm
Pinza de aprehension amigdalas, longitud total 200mm
Pince préhension amygdales, longueur totale 200mm

470-522



TYDING

Tonsillenfasszange, Gesamtlänge 210mm
Tonsil forceps, total length 210mm
Pinza de aprehension amigdalas, longitud total 210mm
Pince préhension amygdales, longueur totale 210mm

470-515





NEGUS

Tonsillenklemme, Gesamtlänge 190mm
Tonsil forceps, total length 190mm
Pinza para amigdalas, longitud total 190mm
Pince pour amygdales, longueur totale 190mm

- 470-630** weite Biegung / large curve
curva larga / courbe large
470-631 enge Biegung / narrow curve
curva estrecha / courbe étroite



SCHNIDT

Tonsillenklemme, Gesamtlänge 190mm
Tonsil forceps, total length 190mm
Pinza para amigdalas, longitud total 190mm
Pince pour amygdales, longueur totale 190mm

- 151-621** leicht gebogen / slightly curved
curva ligera / courbe légère
151-623 stark gebogen / strong curved
curva fuerte / courbe forte



THILENIUS

Tonsillenabszesszange, Gesamtlänge 200mm
Tonsil abscess forceps, total length 200mm
Pinza absceso amigdalas, longitud total 200mm
Pince abcès amygdales, longueur totale 200mm

470-660

NAGER

Tonsillennadel, Gesamtlänge 240mm
Tonsil needle, total length 240mm
Aguja para amigdalas, longitud total 240mm
Aiguille pour amygdales, longueur totale 240mm

470-721



HURD

Tonsillennadel, Gesamtlänge 210mm
Tonsil needle, total length 210mm
Aguja para amigdalas, longitud total 210mm
Aiguille pour amygdales, longueur totale 210mm

470-726 für die linke Hand / for the left hand
para la mano izquierda / pour la main gauche
470-727 für die rechte Hand / for the right hand
para la mano derecha / pour la main droite

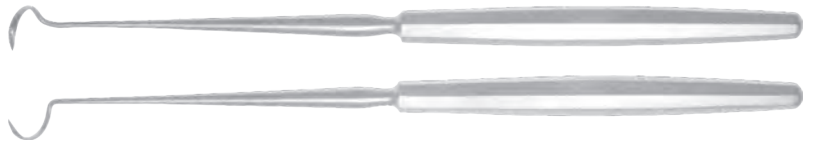

ABRAHAM

Tonsillennmesser, Gesamtlänge 220mm
Tonsil knife, total length 220mm
Cuchillo para amigdalas, longitud total 220mm
Bistouri pour amygdales, longueur totale 220mm

470-810



BRÜNINGS

Tonsillennmesser, Gesamtlänge 230mm
Tonsil knife, total length 230mm
Cuchillo para amigdalas, longitud total 230mm
Bistouri pour amygdales, longueur totale 230mm

470-817



FISHER (COLVER)

Tonsillennmesser, Gesamtlänge 225mm
Tonsil knife, total length 225mm
Cuchillo para amigdalas, longitud total 225mm
Bistouri pour amygdales, longueur totale 225mm

470-850





HURD

Tonsillendissektor und Retraktor, Gesamtlänge 225mm
Tonsil dissector and pillar retractor, total length 225mm
Disector y retractor para amigdalas, longitud total 225mm
Décolleur et écarteur pour amygdales, longueur totale 225mm

470-900

Breite 6mm / width 6mm
anchura 6mm / largeur 6mm

470-901

Breite 10mm / width 10mm
anchura 10mm / largeur 10mm



HENKE

Tonsillendissektor und Separator, Gesamtlänge 230mm
Tonsil dissector and separator, total length 230mm
Disector y separador para amigdalas, longitud total 230mm
Décolleur et séparateur pour amygdales, longueur totale 230mm

470-910

Breite 12mm / width 12mm
anchura 12mm / largeur 12mm

470-911

Breite 17mm / width 17mm
anchura 17mm / largeur 17mm



NAGER

Gaumensegelhaken, Gesamtlänge 230mm
Pillar retractor, total length 230mm
Gancho para velo del paladar, longitud total 230mm
Crochet pour voile du palais, longueur totale 230mm

471-106

TONSILLENSCHNÜRER
TONSIL SNARE
CIERRA NUDOS PARA AMIGDALAS
SERRE-NOEUD AMYGDALAS

ELCON
HNO - ENT - ORL

EVE

Tonsillenschnürer, Gesamtlänge 280mm
Tonsil snare, total length 280mm
Cierra nudos para amigdalas, longitud total 280mm
Serre-noeud amygdales, longueur totale 280mm

471-200

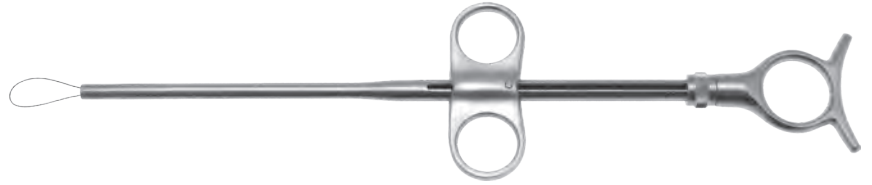

EVE

Tonsillenschnürer, mit Sperre, Gesamtlänge 280mm
Tonsil snare, with ratchet, total length 280mm
Cierra nudos para amigdalas, con cierre, longitud total 280mm
Serre-noeud amygdales, avec blocage, longueur totale 280mm

471-205



BRUENINGS

Tonsillenschnürer, mit Sperre, Gesamtlänge 280mm
Tonsil snare, with ratchet, total length 280mm
Cierra nudos para amigdalas, con cierre, longitud total 280mm
Serre-noeud amygdales, avec blocage, longueur totale 280mm

471-210

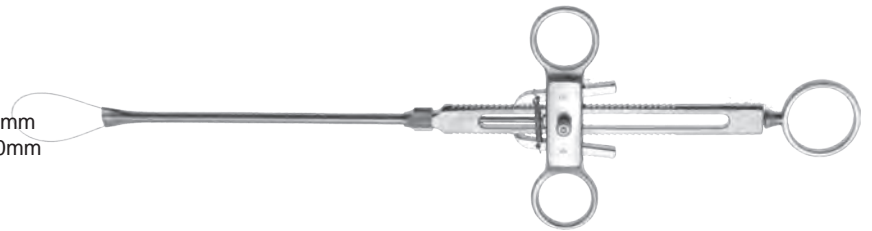

TYDING

Tonsillenschnürer, mit geradem Aufsatz
Tonsil snare, with straight tip
Cierra nudos para amigdalas, con punta recta
Serre-noeud amygdales, avec insert droit

471-230

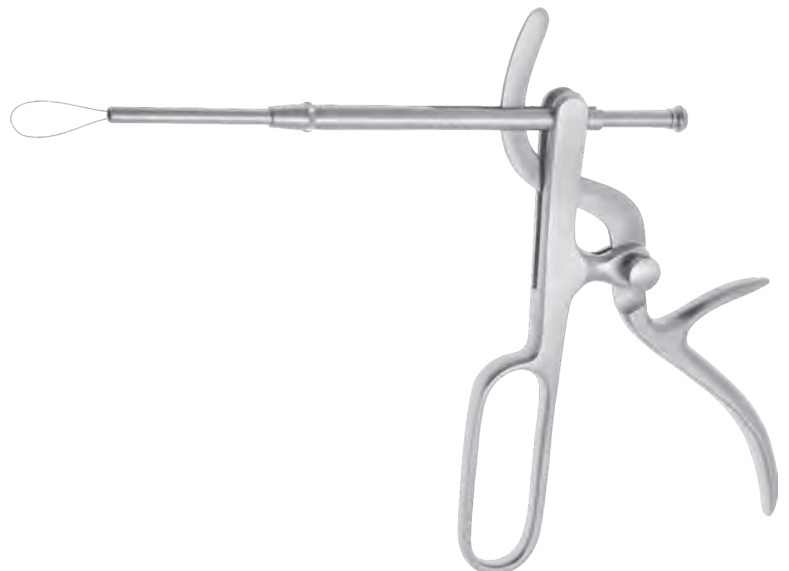



Schnürerdraht für Tonsillenschnürer, Packung à 12 Stück
Tonsil snare wires, 1 dozen
Alambre para cierra nudos para amigdalas, paquete de 12 unidades
Anses pour serre-noeud amygdales, paquet de 12 pièces

471-270-45 Ø 0,45mm, 100mm

471-270-50 Ø 0,50mm, 100mm

471-270-55 Ø 0,55mm, 100mm

471-271-35 Ø 0,35mm, 115mm

471-271-40 Ø 0,40mm, 115mm

471-271-45 Ø 0,45mm, 115mm

471-271-50 Ø 0,50mm, 115mm

471-271-55 Ø 0,55mm, 115mm



Schnürerdraht für Tonsillenschnürer, Packung à 100 Stück
Tonsil snare wires, 100 pieces
Alambre para cierra nudos para amigdalas, paquete de 100 unidades

Anses pour serre-noeud amygdales, paquet de 100 pièces

471-275-45 Ø 0,45mm, 100mm

471-275-50 Ø 0,50mm, 100mm

471-275-55 Ø 0,55mm, 100mm



Tonsillenschlingen geschlossen, Packung à 100 Stück
Tonsil wire loops closed, 100 pieces
Lazos de alambre, paquete de 100 unidades
Boucles fermées pour amygdales, paquet de 100 pièces

471-290 Ø 0,40mm, 50mm

471-291 Ø 0,40mm, 40mm

SLUDDER-BALLENGER

Tonsillotom, komplett mit 3 Aufsätzen und Griff
Tonsillotome, complete with 3 blades and handle
Amigdalotomo, completo con 3 hojas y mango
Amygdalotome, complet avec 3 lames et poignée

471-520-00

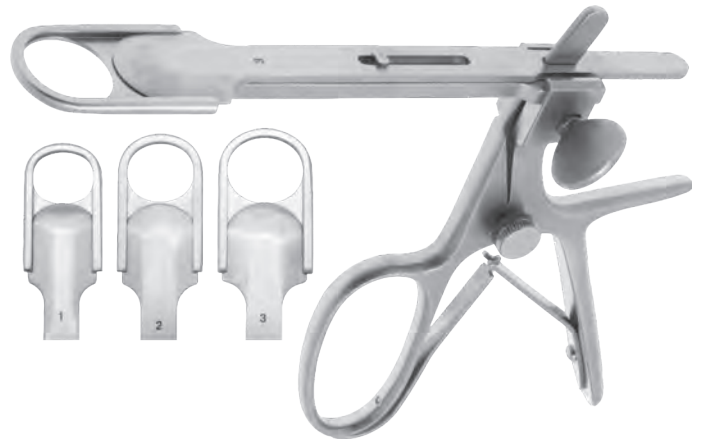

SLUDDER-BALLENGER

Aufsatz alleine
Blade only
Hojas solas
Lame seule

471-521 Fig.1

471-522 Fig.2

471-523 Fig.3

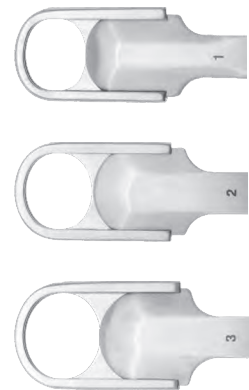

SLUDDER-BALLENGER

Griff alleine
Handle only
Mango solo
Poignée seule

471-528





LA FORCE

Adenotom, demontierbar, Gesamtlänge 230mm
Adenotome, detachable, total length 230mm
Adenotomo, demontable, longitud total 230mm
Adénotome, démontable, longueur totale 230mm

471-500 Fig.1, 18mm
471-501 Fig.2, 16mm
471-502 Fig.3, 12mm



Ersatzklingen, gelocht (kein Medizinprodukt)
Spare blades, perforated (no medical device)
Hojas de reemplazo, perforadas (no es un producto sanitario)
Lames de rechange, perforées (pas de produit médical)

471-510 Fig.1, 18mm
471-511 Fig.2, 16mm
471-512 Fig.3, 12mm

BARNHILL

Ringmesser, Gesamtlänge 220mm
Adenoid currettes, total length 220mm
Cuchillo para adenoides, longitud total 220mm
Curette à végétation, longueur totale 220mm

- 471-600 Fig.0, 11mm
- 471-601 Fig.1, 13mm
- 471-602 Fig.2, 15mm
- 471-603 Fig.3, 17mm
- 471-604 Fig.4, 19mm



BECKMANN

Ringmesser, Gesamtlänge 220mm
Adenoid currettes, total length 220mm
Cuchillo para adenoides, longitud total 220mm
Curette à végétation, longueur totale 22mm

- 471-611 Fig.1, 10mm
- 471-612 Fig.2, 11mm
- 471-613 Fig.3, 12mm
- 471-614 Fig.4, 13mm
- 471-615 Fig.5, 15mm
- 471-616 Fig.6, 18mm



ST. CLAIR-THOMSON

Ringmesser, mit Fangkorb, Gesamtlänge 220mm
Adenoid currettes, with basket, total length 220mm
Cuchillo para adenoides, con colector, longitud total 220mm
Curette à végétation, à panier, longueur totale 220mm

- 471-629 Fig.00, 8mm
- 471-630 Fig.0, 10mm
- 471-631 Fig.1, 12mm
- 471-632 Fig.2, 14mm
- 471-633 Fig.3, 16mm
- 471-634 Fig.4, 18mm



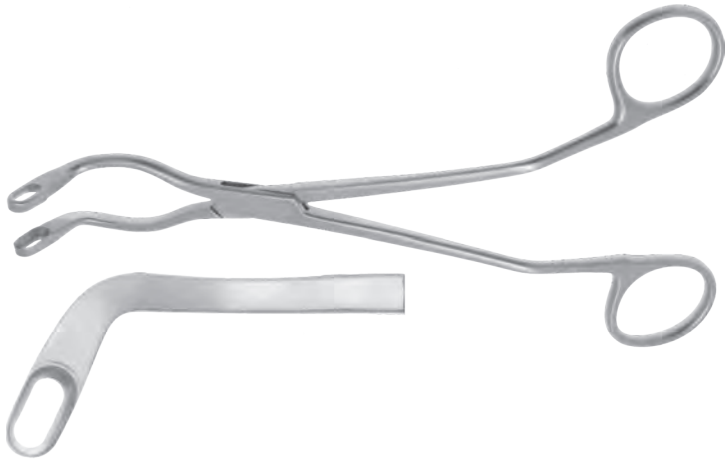

JURASZ

Nasenrachenzange, Gesamtlänge 190mm
Adenoid forceps, total length 190mm
Pinza para adenoïdes, longitud total 190mm
Pince adénoïde, longueur totale 190mm

471-411



JURASZ

Nasenrachenzange, Gesamtlänge 220mm
Adenoid forceps, total length 220mm
Pinza para adenoïdes, longitud total 220mm
Pince adénoïde, longueur totale 220mm

471-413 Fig.1

471-415 Fig.2

KOENIG

Metallspritze mit Glaszylinder, Luer-Lock
Metal syringe with glass barrell, Luer-lock
Jeringa de metal con cilindro de vidrio, Luer-lock
Seringue en métal avec cylindre en verre, Luer-Lock

198-204 5ml



Tonsillenenkanüle
Tonsil needle
Canula para amigdalas
Aiguille amygdalas

- 198-810** gerade, straight, recta, droite
- 198-811** 45° gebogen, 45° curved, curva 45°, courbée 45°
- 198-812** 90° gebogen, 90° curved, curva 90°, courbée 90°
- 198-813** abgewinkelt, angled, angulada, angulée
- 198-814** bajonettförmig, bayonet shaped, forma bayoneta, forme baïonnette



Kehlkopfkanüle, Gesamtlänge 130mm
Laryngeal cannula, total length 130mm
Canula laringeal, longitud total 130mm
Canule laryngée, longueur totale 130mm

198-816 gebogen, curved, curva, courbée





MICHEL

Rinoskopie Spiegel, Gesamtlänge 290mm
Rhinoscopic mirror, total length 290mm
Espejo de rinoscopia, longitud total 290mm
Miroir pour rhinoscopie, longueur totale 290mm

480-150	Ø 10mm
480-151	Ø 12mm
480-152	Ø 14mm
480-153	Ø 16mm
480-154	Ø 18mm



Kehlkopfspiegel, mit Handgriff
Laryngeal mirror, with handle
Espejo laringeal, con mango
Miroir laryngé, avec manche

480-099	Fig.000, Ø 6mm
480-100	Fig.00, Ø 8mm
480-101	Fig.0, Ø 10mm
480-102	Fig.1, Ø 12mm
480-103	Fig.2, Ø 14mm
480-104	Fig.3, Ø 16mm
480-105	Fig.4, Ø 18mm
480-106	Fig.5, Ø 20mm
480-107	Fig.6, Ø 22mm
480-108	Fig.7, Ø 24mm
480-109	Fig.8, Ø 26mm
480-110	Fig.9, Ø 28mm
480-111	Fig.10, Ø 30mm



Kehlkopfspiegel, ohne Griff, mit Gewinde
Laryngeal mirror, without handle, with thread
Espejo laringeal, sin mango, con rosca
Miroir laryngé, sans manche, avec filet

480-119	Fig.000, Ø 6mm
480-120	Fig.00, Ø 8mm
480-121	Fig.0, Ø 10mm
480-122	Fig.1, Ø 12mm
480-123	Fig.2, Ø 14mm
480-124	Fig.3, Ø 16mm
480-125	Fig.4, Ø 18mm
480-126	Fig.5, Ø 20mm
480-127	Fig.6, Ø 22mm
480-128	Fig.7, Ø 24mm
480-129	Fig.8, Ø 26mm
480-130	Fig.9, Ø 28mm
480-131	Fig.10, Ø 30mm



Handgriff für Kehlkopfspiegel, Gesamtlänge 105mm
Handle for laryngeal mirror, total length 105mm
Mango para espejo laringeal, longitud total 105mm
Manche pour miroir laryngé, longueur totale 105mm

480-136



Handgriff für Kehlkopfspiegel, Gesamtlänge 70mm
Handle for laryngeal mirror, total length 70mm
Mango para espejo laringeal, longitud total 70mm
Manche pour miroir laryngé, longueur totale 70mm

480-138

Kehlkopfspiegel, Rhodium beschichtet, ohne Griff, mit Gewinde
Laryngeal mirror, rhodium coated, without handle, with thread
Espejo laringeal, revestido con rodio, sin mango, con rosca
Miroir laryngé, avec couche rhodium, sans manche, avec filet

- 480-160-06** Fig.000, Ø 6mm.
- 480-160-08** Fig.00, Ø 8mm
- 480-160-10** Fig.0, Ø 10mm
- 480-160-12** Fig.1, Ø 12mm
- 480-160-14** Fig.2, Ø 14mm
- 480-160-16** Fig.3, Ø 16mm
- 480-160-18** Fig.4, Ø 18mm
- 480-160-20** Fig.5, Ø 20mm
- 480-160-22** Fig.6, Ø 22mm
- 480-160-24** Fig.7, Ø 24mm
- 480-160-26** Fig.8, Ø 26mm
- 480-160-28** Fig.9, Ø 28mm
- 480-160-30** Fig.10, Ø 30mm



Kehlkopfspiegel, Rhodium beschichtet, mit Griff
Laryngeal mirror, rhodium coated, with handle
Espejo laringeal, revestido con rodio, con mango
Miroir laryngé, avec couche rhodium, avec manche

- 480-170-06** Fig.000, Ø 6mm.
- 480-170-08** Fig.00, Ø 8mm
- 480-170-10** Fig.0, Ø 10mm
- 480-170-12** Fig.1, Ø 12mm
- 480-170-14** Fig.2, Ø 14mm
- 480-170-16** Fig.3, Ø 16mm
- 480-170-18** Fig.4, Ø 18mm
- 480-170-20** Fig.5, Ø 20mm
- 480-170-22** Fig.6, Ø 22mm
- 480-170-24** Fig.7, Ø 24mm
- 480-170-26** Fig.8, Ø 26mm
- 480-170-28** Fig.9, Ø 28mm
- 480-170-30** Fig.10, Ø 30mm





REICHERT

Kehledeckelhalter, Gesamtlänge 240mm

Epiglottis holder, total length 240mm

Apoyo del epiglotis, longitud total 240mm

Soutien épiglotte, longueur totale 240mm

481-791



HUBER

Universalgriff
Universal handle
Mango universal
Poignée universelle

441-900



Verlängerungsrohr, gerade
Extension tube, straight
Tubo de extension, recto
Tube rallongement, droit

481-900-20 200mm

481-900-30 300mm

481-900-40 400mm

481-900-50 500mm

481-900-60 600mm



Verlängerungsrohr, gebogen
Extension tube, curved
Tubo de extension, curvo
Tube rallongement, courbé

481-901-20 200mm

FRAENKEL

Kehlkopfzangenaufsatz, gerade, gerieft
Laryngeal forceps tip, straight, serrated
Enfoque para pinza de laringe, recto, estrillado
Embout pince pour larynx, droit, strié

481-945



SEIFFERT

Kehlkopfzangenaufsatz, Hechtmaul
Laryngeal forceps tip, pike mouth shape
Enfoque para pinza de laringe, boca forma de lucio
Embout pince pour larynx, forme bouche de brochet

481-950



BARACANI

Kehlkopfzangenaufsatz, gerade, gerieft
Laryngeal forceps tip, straight, serrated
Enfoque para pinza de laringe, recto, estrillado
Embout pince pour larynx, droit, strié

481-951



FRAENKEL

Kehlkopfzangenaufsatz, gerade, langer ovaler Löffel
Laryngeal forceps tip, straight, long oval cup
Enfoque para pinza de laringe, recto, cuchara larga ovalada
Embout pince pour larynx, droit, cuillère ovale longue

481-952



LANGE

Kehlkopfzangenaufsatz, gerade, ovaler Löffel
Laryngeal forceps tip, straight, oval cup
Enfoque para pinza de laringe, recto, cuchara ovalada
Embout pince pour larynx, droit, cuillère ovale

481-953-20 2,0mm breit / width 2,0mm / anchura 2,0mm / largeur 2,0mm

481-953-30 3,0mm breit / width 3,0mm / anchura 3,0mm / largeur 3,0mm

481-953-40 4,0mm breit / width 4,0mm / anchura 4,0mm / largeur 4,0mm



BRUENINGS

Kehlkopfzangenaufsatz, gerade, runder Löffel
Laryngeal forceps tip, straight, round cup
Enfoque para pinza de laringe, recto, cuchara redonda
Embout pince pour larynx, droit, cuillère ronde

481-954-20 Ø 2,0mm

481-954-30 Ø 3,0mm

481-954-40 Ø 4,0mm



BRUENINGS

Kehlkopfzangenaufsatz, aufgebogen, runder Löffel
Laryngeal forceps tip, angled up, round cup
Enfoque para pinza de laringe, curvo hacia arriba, cuchara redonda
Embout pince pour larynx, vers le haut, cuillère ronde

481-955-20 Ø 2,0mm

481-955-30 Ø 3,0mm

481-955-40 Ø 4,0mm



SCHEINMANN

Kehlkopfzangenaufsatz, gerade, Löffel abgewinkelt
Laryngeal forceps tip, straight, angled cup
Enfoque para pinza de laringe, recto, cuchara angulada
Embout pince pour larynx, droit, cuillère vers le bas

481-959



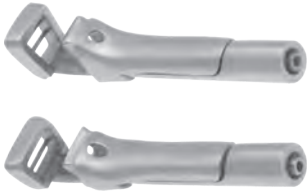

CORDES

Kehlkopfzangenaufsatz, eckig stanzend
Laryngeal forceps tip, square punch
Enfoque para pinza de laringe, punzonada cuadrada
Embout pince pour larynx, découpe carrée

481-960 Fig.1

481-961 Fig.2



CORDES

Kehlkopfzangenaufsatz, rund stanzend
Laryngeal forceps tip, round punch
Enfoque para pinza de laringe, punzonada redonda
Embout pince pour larynx, découpe ronde

481-962-01 Fig.1

481-962-02 Fig.2

481-962-03 Fig.3

481-962-04 Fig.4



KRAUSE

Kehlkopfzangenaufsatz, gerade, oval durchschneidend
Laryngeal forceps tip, straight, oval trough cutting
Enfoque para pinza de laringe, recto, cortante ovalado
Embout pince pour larynx, droit, tranchant en ovale

481-964-30 Ausschnitt 3,0mm / bite 3,0mm / recorte 3,0mm / découpe 3,0mm

481-964-36 Ausschnitt 3,6mm / bite 3,6mm / recorte 3,6mm / découpe 3,6mm

481-964-42 Ausschnitt 4,2mm / bite 4,2mm / recorte 4,2mm / découpe 4,2mm



KRAUSE

Kehlkopfzangenaufsatz, gerade, eckig durchschneidend
Laryngeal forceps tip, straight, square trough cutting
Enfoque para pinza de laringe, recto, cortante cuadrada
Embout pince pour larynx, droit, tranchant en carré

481-966-30 Ausschnitt 3,0mm / bite 3,0mm / recorte 3,0mm / découpe 3,0mm

481-966-36 Ausschnitt 3,6mm / bite 3,6mm / recorte 3,6mm / découpe 3,6mm

481-966-42 Ausschnitt 4,2mm / bite 4,2mm / recorte 4,2mm / découpe 4,2mm



SCHUHMACHER

Kehlkopfzangenaufsatz, gerade, dreieckig durchschneidend
Laryngeal forceps tip, straight, triangular through-cutting
Enfoque para pinza de laringe, recto, cortante triangular
Embout pince pour larynx, droit, tranchant en triangulaire

481-968



SCHEINMANN

Kehlkopfzangenaufsatz, gebogen, durchschneidend
Laryngeal forceps tip, curved, through-cutting
Enfoque para pinza de laringe, curva, cortante
Embout pince pour larynx, courbé tranchant

481-972

**MINIATURE LARYNGEAL ZANGEN
MINIATURE LARYNGEAL FORCEPS
PINZAS MINIATURA PARA CIRURGIA DE LARINGE
PINCES MINIATURE POUR CHIRURGIE DU LARYNX**

ELCON
HNO - ENT - ORL

Miniature Instrumente: konisch zulaufender Rohrschaft für hohe Stabilität und optimale Sicht Rohrschaft Ø 1mm (Instrumentenseits) auf Ø 2mm (Griffseits)
Miniature instruments: conical shaft for high stability and optimal view, tubular shaft Ø 1mm (instrument side) to Ø 2mm (handle side)
Instrumentos miniatura: tubo cónico para alta estabilidad y visibilidad, tubo tubular Ø 1mm (lado de instrumento) a Ø 2mm (lado de mango)
Instruments miniature : tige conique pour grande stabilité et vue optimale, tige tubulaire Ø 1mm (côté instrument) à Ø 2mm (côté poignée)

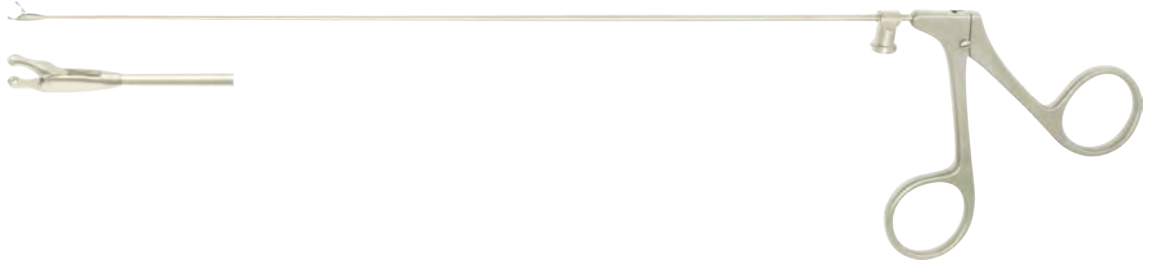

Arbeitslänge 180mm / working length 180mm longitud de trabajo 180mm /longueur de travail 180mm	
runder Löffel Ø 1,0mm round cups Ø 1,0mm cuchara redonda Ø 1,0mm cuillère ronde Ø 1,0mm	
gerade / straight recta / droit	482-5000-18
aufgebogen / curved up curva hacia arriba / courbé vers le haut	482-5001-18
rechts gebogen / curved right curva derecha / courbée droit	482-5002-18
links gebogen / curved left curva izquierda / courbé gauche	482-5003-18
aufgebogen rechts / curved up right curva hacia arriba derecha/ courbé vers le haut à droite	482-5004-18
aufgebogen links / curved up left curva hacia arriba izquierda / courbé vers le haut à gauche	482-5005-18









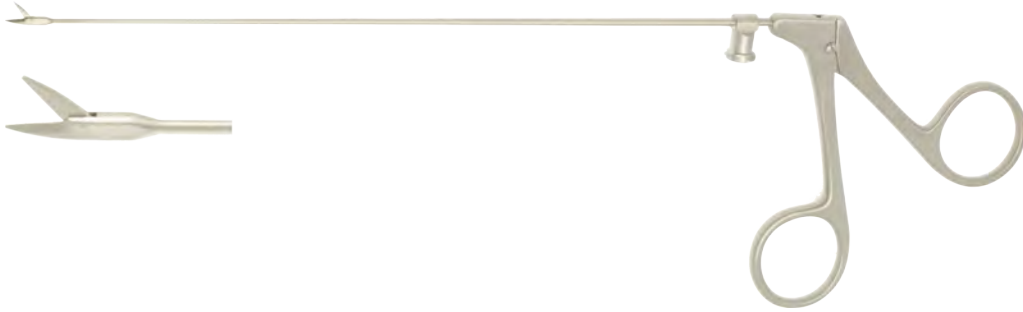





Arbeitslänge 230mm / working length 230mm longitud de trabajo 230mm / longueur de travail 230mm	
runder Löffel Ø 1,0mm round cups Ø 1,0mm cuchara redonda Ø 1,0mm cuillère ronde Ø 1,0mm	
gerade / straight recta / droit	482-5000-23
aufgebogen / curved up curva hacia arriba / courbé vers le haut	482-5001-23
rechts gebogen / curved right curva derecha / courbée droit	482-5002-23
links gebogen / curved left curva izquierda / courbé gauche	482-5003-23
aufgebogen rechts / curved up right curva hacia arriba derecha / courbé vers le haut à droite	482-5004-23
aufgebogen links / curved up left curva hacia arriba izquierda / courbé vers le haut à gauche	482-5005-23



Miniature Instrumente: konisch zulaufender Rohrschaft für hohe Stabilität und optimale Sicht Rohrschaft Ø 1mm (Instrumentenseits) auf Ø 2mm (Griffseits)
 Miniature instruments: conical shaft for high stability and optimal view, tubular shaft Ø 1mm (instrument side) to Ø 2mm (handle side)
 Instrumentos miniatura: tubo cónico para alta estabilidad y visibilidad, tubo tubular Ø 1mm (lado de instrumento) a Ø 2mm (lado de mango)
 Instruments miniature : tige conique pour grande stabilité et vue optimale, tige tubulaire Ø 1mm (côté instrument) à Ø 2mm (côté poignée)



Arbeitslänge 180mm / working length 180mm longitud de trabajo 180mm / longueur de travail 180mm	
	
 482-5050-18	gerade / straight recta / droit
 482-5051-18	45° aufgebogen / curved up 45° 45° curva hacia arriba / 45° courbé vers le haut
 482-5053-18	rechts gebogen / curved right curva derecha / courbé droite
 482-5054-18	links gebogen / curved left curva izquierda / courbé gauche
 482-5050H-18	horizontal schneidend / horizontal cutting cortante horizontal / coupe horizontale

Arbeitslänge 230mm / working length 230mm longitud de trabajo 230mm /longueur de travail 230mm	
	
 482-5050-23	gerade / straight recta / droit
 482-5051-23	45° aufgebogen / curved up 45° 45° curva hacia arriba / 45° courbé vers le haut
 482-5053-23	rechts gebogen / curved right curva derecha / courbé droite
 482-5054-23	links gebogen / curved left curva izquierda / courbé gauche
 482-5050H-23	horizontal schneidend / horizontal cutting cortante horizontal / coupe horizontale

**MINIATURE LARYNGEAL ZANGEN
MINIATURE LARYNGEAL FORCEPS
PINZAS MINIATURA PARA CIRURGIA DE LARINGE
PINCES MINIATURE POUR CHIRURGIE DU LARYNX**

ELCON
HNO - ENT - ORL

Miniature Instrumente: konisch zulaufender Rohrschaft für hohe Stabilität und optimale Sicht Rohrschaft Ø 1mm (Instrumentenseits) auf Ø 2mm (Griffseits)
Miniature instruments: conical shaft for high stability and optimal view, tubular shaft Ø 1mm (instrument side) to Ø 2mm (handle side)
Instrumentos miniatura: tubo cónico para alta estabilidad y visibilidad, tubo tubular Ø 1mm (lado de instrumento) a Ø 2mm (lado de mango)
Instruments miniature : tige conique pour grande stabilité et vue optimale, tige tubulaire Ø 1mm (côté instrument) à Ø 2mm (côté poignée)

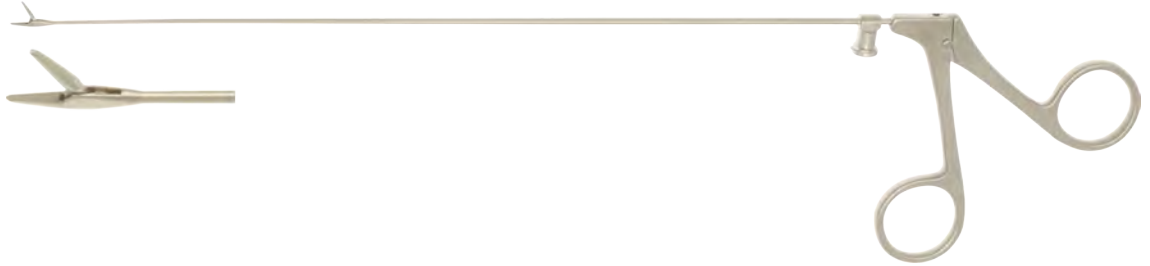

Arbeitslänge 180mm / working length 180mm longitud de trabajo 180mm / longueur de travail 180mm	
gerieft serrated estriada strié	
gerade / straight recta / droit	482-5070-18
horizontal öffnend / horizontal opening abertura horizontal / ouverture horizontale	482-5070H-18
aufgebogen / curved up curva hacia arriba / courbé vers le haut	482-5071-18
rechts gebogen / curved right curva derecha / courbé droite	482-5072-18
links gebogen / curved left curva izquierda / courbé gauche	482-5073-18



Arbeitslänge 230mm / working length 230mm longitud de trabajo 230mm / longueur de travail 230mm	
gerieft serrated estriada strié	
gerade / straight recta / droit	482-5070-23
horizontal öffnend / horizontal opening abertura horizontal / ouverture horizontale	482-5070H-23
aufgebogen / curved up curva hacia arriba / courbé vers le haut	482-5071-23
rechts gebogen / curved right curva derecha / courbé droite	482-5072-23
links gebogen / curved left curva izquierda / courbé gauche	482-5073-23



Miniature Instrumente: konisch zulaufender Rohrschaft für hohe Stabilität und optimale Sicht Rohrschaft Ø 1mm (Instrumentenseits) auf Ø 2mm (Griffseits)
 Miniature instruments: conical shaft for high stability and optimal view, tubular shaft Ø 1mm (instrument side) to Ø 2mm (handle side)
 Instrumentos miniatura: tubo cónico para alta estabilidad y visibilidad, tubo tubular Ø 1mm (lado de instrumento) a Ø 2mm (lado de mango)
 Instruments miniature : tige conique pour grande stabilité et vue optimale, tige tubulaire Ø 1mm (côté instrument) à Ø 2mm (côté poignée)



Arbeitslänge 180mm / working length 180mm longitud de trabajo 180mm /longueur de travail 180mm	
	dreieckig gerieft triangular serrated triangular estriada triangulaire, strié
482-5092-18	aufgebogen rechts / curved up right curva hacia arriba derecha / courbé vers le haut à droite
482-5093-18	aufgebogen links / curved up left curva hacia arriba izquierda / courbé vers le haut à gauche



Arbeitslänge 230mm / working length 230mm longitud de trabajo 230mm /longueur de travail 230mm	
	dreieckig gerieft triangular serrated triangular estriada triangulaire, strié
482-5092-23	aufgebogen rechts / curved up right curva hacia arriba derecha / courbé vers le haut à droite
482-5093-23	aufgebogen links / curved up left curva hacia arriba izquierda / courbé vers le haut à gauche



**MIKRO LARYNGEAL ZANGEN
MICRO LARYNGEAL FORCEPS
PINZAS PARA MICRO-CIRURGÍA DE LARINGE
PINCES POUR MICRO-CHIRURGIE DU LARYNX**

ELCON
HNO - ENT - ORL

Micro Instrumente: konisch zulaufender Rohrschaft für hohe Stabilität und optimale Sicht Rohrschaft Ø 2mm (Instrumentenseits) auf Ø 3mm (Griffseits)
Micro instruments: conical shaft for high stability and optimal view, tubular shaft Ø 2mm (instrument side) to Ø 3mm (handle side)
Instrumentos micro: tubo cónico para alta estabilidad y visibilidad, tubo tubular Ø 2mm (lado de instrumento) a Ø 3mm (lado de mango)
Instruments micro : tige conique pour grande stabilité et vue optimale, tige tubulaire Ø 2mm (côté instrument) à Ø 3mm (côté poignée)



Arbeitslänge 180mm / working length 180mm longitud de trabajo 180mm /longueur de travail 180mm	
runder Löffel Ø 2,0mm round cups Ø 2,0mm cuchara redonda Ø 2,0mm cuillère ronde Ø 2,0mm	
gerade / straight recta / droit	482-5110-18
aufgebogen / curved up curva hacia arriba / courbé vers le haut	482-5111-18
rechts gebogen / curved right curva derecha / courbé droite	482-5112-18
links gebogen / curved left curva izquierda / courbé gauche	482-5113-18
aufgebogen rechts / curved up right curva hacia arriba derecha / courbé vers le haut à droite	482-5114-18
aufgebogen links / curved up left curva hacia arriba izquierda / courbé vers le haut à gauche	482-5115-18













Arbeitslänge 230mm / working length 230mm longitud de trabajo 230mm /longueur de travail 230mm	
runder Löffel Ø 2,0mm round cups Ø 2,0mm cuchara redonda Ø 2,0mm cuillère ronde Ø 2,0mm	
gerade / straight recta / droit	482-5110-23
aufgebogen / curved up curva hacia arriba / courbé vers le haut	482-5111-23
rechts gebogen / curved right curva derecha / courbé droite	482-5112-23
links gebogen / curved left curva izquierda / courbé gauche	482-5113-23
aufgebogen rechts / curved up right curva hacia arriba derecha/ courbé vers le haut à droite	482-5114-23
aufgebogen links / curved up left curva hacia arriba izquierda / courbé vers le haut à gauche	482-5115-23



Micro Instrumente: konisch zulaufender Rohrschaft für hohe Stabilität und optimale Sicht Rohrschaft Ø 2mm (Instrumentenseits) auf Ø 3mm (Griffseite)
 Micro instruments: conical shaft for high stability and optimal view, tubular shaft Ø 2mm (instrument side) to Ø 3mm (handle side)
 Instrumentos micro: tubo cónico para alta estabilidad y visibilidad, tubo tubular Ø 2mm (lado de instrumento) a Ø 3mm (lado de mango)
 Instruments micro : tige conique pour grande stabilité et vue optimale, tige tubulaire Ø 2mm (côté instrument) à Ø 3mm (côté poignée)



Arbeitslänge 180mm / working length 180mm longitud de trabajo 180mm / longueur de travail 180mm	
	runder Löffel Ø 3,0mm round cups Ø 3,0mm cuchara redonda Ø 3,0mm cuillère ronde Ø 3,0mm
 482-5120-18	gerade / straight recta / droit
 482-5121-18	aufgebogen / curved up curva hacia arriba / courbé vers le haut
 482-5122-18	rechts gebogen / curved right curva derecha / courbé droite
 482-5123-18	links gebogen / curved left curva izquierda / courbé gauche
482-5124-18	aufgebogen rechts / curved up right curva hacia arriba derecha / courbé vers le haut à droite
482-5125-18	aufgebogen links / curved up left curva hacia arriba izquierda / courbé vers le haut à gauche

Arbeitslänge 230mm / working length 230mm longitud de trabajo 230mm / longueur de travail 230mm	
	runder Löffel Ø 3,0mm round cups Ø 3,0mm cuchara redonda Ø 3,0mm cuillère ronde Ø 3,0mm
 482-5120-23	gerade / straight recta / droit
 482-5121-23	aufgebogen / curved up curva hacia arriba / courbé vers le haut
 482-5122-23	rechts gebogen / curved right curva derecha / courbé droite
 482-5123-23	links gebogen / curved left curva izquierda / courbé gauche
482-5124-23	aufgebogen rechts / curved up right curva hacia arriba derecha / courbé vers le haut à droite
482-5125-23	aufgebogen links / curved up left curva hacia arriba izquierda / courbé vers le haut à gauche

**MIKRO LARYNGEAL ZANGEN
MICRO LARYNGEAL FORCEPS
PINZAS PARA MICRO-CIRURGIA DE LARINGE
PINCES POUR MICRO-CHIRURGIE DU LARYNX**

ELCON
HNO - ENT - ORL

Micro Instrumente: konisch zulaufender Rohrschaft für hohe Stabilität und optimale Sicht Rohrschaft Ø 2mm (Instrumentenseits) auf Ø 3mm (Griffseits)
Micro instruments: conical shaft for high stability and optimal view, tubular shaft Ø 2mm (instrument side) to Ø 3mm (handle side)
Instrumentos micro: tubo cónico para alta estabilidad y visibilidad, tubo tubular Ø 2mm (lado de instrumento) a Ø 3mm (lado de mango)
Instruments micro : tige conique pour grande stabilité et vue optimale, tige tubulaire Ø 2mm (côté instrument) à Ø 3mm (côté poignée)



Arbeitslänge 230mm / working length 230mm longitud de trabajo 230mm /longueur de travail 230mm	
runder Löffel Ø 4,0mm round cups Ø 4,0mm cuchara redonda Ø 4,0mm cuillère ronde Ø 4,0mm	
gerade / straight recta / droit	482-5130-23
aufgebogen / curved up curva hacia arriba / courbé vers le haut	482-5131-23
rechts gebogen / curved right curva derecha / courbé droite	482-5132-23
links gebogen / curved left curva izquierda / courbé gauche	482-5133-23



Arbeitslänge 230mm / working length 230mm longitud de trabajo 230mm / longueur de travail 230mm	
Löffel 3,00x5,00mm cups 3,00x5,00mm cuchara 3,00x5,00mm cuillère 3,00x5,00mm	
gerade / straight recta / droit	482-5140-23
aufgebogen / curved up curva hacia arriba / courbé vers le haut	482-5141-23
rechts gebogen / curved right curva derecha / courbé droite	482-5143-23
links gebogen / curved left curva izquierda / courbé gauche	482-5144-23

Micro Instrumente: konisch zulaufender Rohrschaft für hohe Stabilität und optimale Sicht Rohrschaft Ø 2mm (Instrumentenseits) auf Ø 3mm (Griffseits)
 Micro instruments: conical shaft for high stability and optimal view, tubular shaft Ø 2mm (instrument side) to Ø 3mm (handle side)
 Instrumentos micro: tubo cónico para alta estabilidad y visibilidad, tubo tubular Ø 2mm (lado de instrumento) a Ø 3mm (lado de mango)
 Instruments micro : tige conique pour grande stabilité et vue optimale, tige tubulaire Ø 2mm (côté instrument) à Ø 3mm (côté poignée)



Arbeitslänge 180mm / working length 180mm longitud de trabajo 180mm / longueur de travail 180mm	
482-5150-18	gerade / straight recta / droit
482-5151-18	45° aufgebogen / curved up 45° 45° curva hacia arriba / 45°courbé vers le haut
482-5152-18	15° aufgebogen / curved up 15° 15° curva hacia arriba / 15°courbé vers le haut
482-5153-18	rechts gebogen / curved right curva derecha / courbé droite
482-5154-18	links gebogen / curved left curva izquierda / courbé gauche
482-5150H-18	horizontal schneidened / horizontal cutting cortante horizontal / coupe horizontale



Arbeitslänge 230mm / working length 230mm longitud de trabajo 230mm / longueur de travail 230mm	
482-5150-23	gerade / straight recta / droit
482-5151-23	45° aufgebogen / curved up 45° 45° curva hacia arriba / 45°courbé vers le haut
482-5152-23	15° aufgebogen / curved up 15° 15° curva hacia arriba / 15°courbé vers le haut
482-5153-23	rechts gebogen / curved right curva derecha / courbé droite
482-5154-23	links gebogen / curved left curva izquierda / courbé gauche
482-5150H-23	horizontal schneidened / horizontal cutting cortante horizontal / coupe horizontale



**MIKRO LARYNGEAL ZANGEN
MICRO LARYNGEAL FORCEPS
PINZAS PARA MICRO-CIRURGIA DE LARINGE
PINCES POUR MICRO-CHIRURGIE DU LARYNX**

ELCON
HNO - ENT - ORL

Micro Instrumente: konisch zulaufender Rohrschaft für hohe Stabilität und optimale Sicht Rohrschaft Ø 2mm (Instrumentenseits) auf Ø 3mm (Griffseits)
Micro instruments: conical shaft for high stability and optimal view, tubular shaft Ø 2mm (instrument side) to Ø 3mm (handle side)
Instrumentos micro: tubo cónico para alta estabilidad y visibilidad, tubo tubular Ø 2mm (lado de instrumento) a Ø 3mm (lado de mango)
Instruments micro : tige conique pour grande stabilité et vue optimale, tige tubulaire Ø 2mm (côté instrument) à Ø 3mm (côté poignée)



Arbeitslänge 180mm / working length 180mm longitud de trabajo 180mm / longueur de travail 180mm	
gerieft serrated estriada strié	
gerade / straight recta / droit	482-5170-18
horizontal öffnend / horizontal opening abertura horizontal / ouverture horizontale	482-5170H-18
aufgebogen / curved up curva hacia arriba / courbé vers le haut	482-5171-18
aufgebogen horizontal öffnend / curved up horizontal opening curva hacia arriba horizontal / courbé vers le haut ouverture horizontale	482-5171H-18
rechts gebogen / curved right curva derecha / courbé droite	482-5172-18
links gebogen / curved left curva izquierda / courbé gauche	482-5173-18

Arbeitslänge 230mm / working length 230mm longitud de trabajo 230mm / longueur de travail 230mm	
gerieft serrated estriada strié	
gerade / straight recta / droit	482-5170-23
horizontal öffnend / horizontal opening abertura horizontal / ouverture horizontale	482-5170H-23
aufgebogen / curved up curva hacia arriba / courbé vers le haut	482-5171-23
aufgebogen horizontal öffnend / curved up horizontal opening curva hacia arriba horizontal / courbé vers le haut ouverture horizontale	482-5171H-23
rechts gebogen / curved right curva derecha / courbé droite	482-5172-23
links gebogen / curved left curva izquierda / courbé gauche	482-5173-23

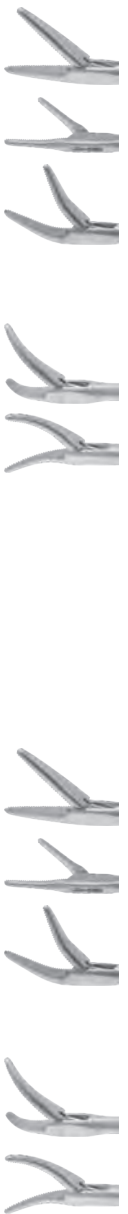

Micro Instrumente: konisch zulaufender Rohrschaft für hohe Stabilität und optimale Sicht Rohrschaft Ø 2mm (Instrumentenseits) auf Ø 3mm (Griffseits)
 Micro instruments: conical shaft for high stability and optimal view, tubular shaft Ø 2mm (instrument side) to Ø 3mm (handle side)
 Instrumentos micro: tubo cónico para alta estabilidad y visibilidad, tubo tubular Ø 2mm (lado de instrumento) a Ø 3mm (lado de mango)
 Instruments micro : tige conique pour grande stabilité et vue optimale, tige tubulaire Ø 2mm (côté instrument) à Ø 3mm (côté poignée)

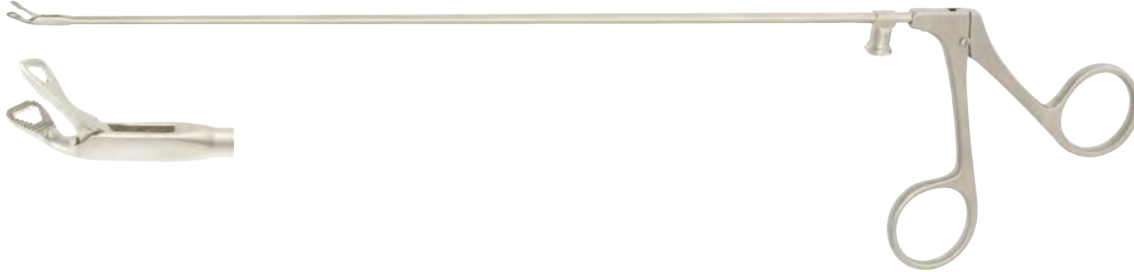

Arbeitslänge 180mm / working length 180mm longitud de trabajo 180mm / longueur de travail 180mm	
	dreieckig gerieft triangular serrated triangular estriada triangulaire, strié
482-5190-18	gerade / straight recta / droit
482-5191-18	aufgebogen / curved up curva hacia arriba / courbé vers le haut
482-5192-18	aufgebogen rechts / curved up right curva hacia arriba derecha/ courbé vers le haut à droite
482-5193-18	aufgebogen links / curved up left curva hacia arriba izquierda / courbé vers le haut à gauche

Arbeitslänge 230mm / working length 230mm longitud de trabajo 230mm / longueur de travail 230mm	
	dreieckig gerieft triangular serrated triangular estriada triangulaire, strié
482-5190-23	gerade / straight recta / droit
482-5191-23	aufgebogen / curved up curva hacia arriba / courbé vers le haut
482-5192-23	aufgebogen rechts / curved up right curva hacia arriba derecha/ courbé vers le haut à droite
482-5193-23	aufgebogen links / curved up left curva hacia arriba izquierda / courbé vers le haut à gauche

MIKRO LARYNGEAL ZANGEN
MICRO LARYNGEAL FORCEPS
PINZAS PARA MICRO-CIRURGIA DE LARINGE
PINCES POUR MICRO-CHIRURGIE DU LARYNX

ELCON
HNO - ENT - ORL



Arbeitslänge 230mm / working length 230mm longitud de trabajo 230mm / longueur de travail 230mm	
gerade / straight recta / droit	482-5250-23

Arbeitslänge 230mm / working length 230mm
 longitud de trabajo 230mm / longueur de travail 230mm



Kleinsasser laryngeal Messer oval
 Kleinsasser laryngeal knife oval
 Kleinsasser cuchillo laringe oval
 Kleinsasser couteau laryngé ovale

482-600



Kleinsasser laryngeal Rundschnittmesser vertikal
 Kleinsasser laryngeal round knife vertical
 Kleinsasser cuchillo laringe de corte ronda vertical
 Kleinsasser couteau laryngé coupe circulaire verticale

482-601



Kleinsasser laryngeal Sichelmesser gebogen
 Kleinsasser laryngeal sickle knife curved
 Kleinsasser cuchillo laringe de hoz curvo
 Kleinsasser couteau laryngé de faucille courbé

482-602



Kleinsasser laryngeal Sichelmesser gerade
 Kleinsasser laryngeal sickle knife straight
 Kleinsasser cuchillo laringe de hoz recto
 Kleinsasser couteau laryngé de faucille droit

482-603



Kleinsasser laryngeal Rundschnittmesser 45° gebogen
 Kleinsasser laryngeal round knife angled 45°
 Kleinsasser cuchillo laringe de corte ronda 45° curva
 Kleinsasser couteau laryngé coupe circulaire 45° courbé

482-604



Kleinsasser laryngeal Haken Sondenknopf 90° abgewinkelt
 Kleinsasser laryngeal hook probe end 90° angled Kleinsa-
 Kleinsasser gancho laringe sonda boton angulado 90°
 Kleinsasser crochet laryngé bouton sonde 90° angulé

482-605



Kleinsasser laryngeal Haken Sondenknopf retrograd geb.
 Kleinsasser laryngeal hook probe end cvd. backwards
 Kleinsasser gancho laringe sonda boton curvo retrogrado
 Kleinsasser crochet laryngé bouton sonde courbé retrograde

482-606



Kleinsasser laryngeal Messer golfstockförmig
 Kleinsasser laryngeal knife golf club shape
 Kleinsasser cuchillo laringe de forma palo de golf
 Kleinsasser couteau laryngé forme de crosse de golf

482-607

Arbeitslänge 230mm / working length 230mm
longitud de trabajo 230mm / longueur de travail 230mm



Kleinsasser laryngeal Haken spitz retrograd geb.
Kleinsasser laryngeal hook sharp cvd. backwards
Kleinsasser gancho laringe agudo curva retrogrado
Kleinsasser crochet laryngé pointu courbé retrograde

482-608



Kleinsasser laryngeal Umführungsnadel rechts gebogen
Kleinsasser laryngeal needle guide curved right
Kleinsasser aguja laringe curva a la derecha
Kleinsasser aiguille guidage laryngée courbée vers la droite

482-610



Kleinsasser laryngeal Umführungsnadel links gebogen
Kleinsasser laryngeal needle guide curved left
Kleinsasser aguja laringe curva a la izquierda
Kleinsasser aiguille guidage laryngée courbée vers la gauche

482-612



Kleinsasser laryngeal Saugraspatorium
Kleinsasser laryngeal suction elevator
Kleinsasser elevador laringe con aspiracion
Kleinsasser élévateur d'aspiration laryngé

482-613



Kleinsasser laryngeal Knotenführer
Kleinsasser laryngeal knot tier
Kleinsasser guia nudo laringe
Kleinsasser guide noeud laryngé

482-614



Kleinsasser Universal Griff für 482-600 bis 482-614
Kleinsasser universal handle for 482-600 to 482-614
Kleinsasser mango universal p. uso con 482-600 a 482-614
Kleinsasser poignée universelle pour 482-600 à 482-614

482-618

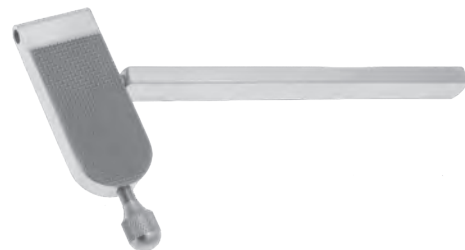

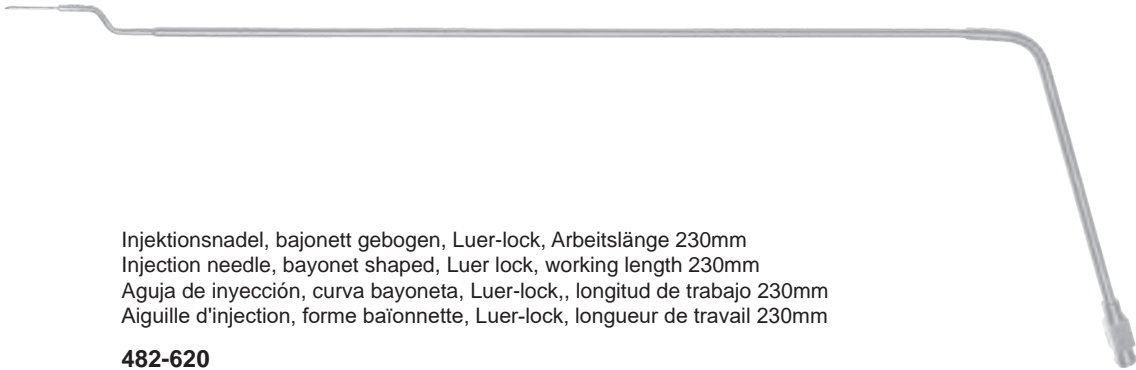

Injektionsnadel, bajonett gebogen, Luer-lock, Arbeitslänge 230mm
Injection needle, bayonet shaped, Luer lock, working length 230mm
Aguja de inyección, curva bayoneta, Luer-lock,, longitud de trabajo 230mm
Aiguille d'injection, forme baïonnette, Luer-lock, longueur de travail 230mm

482-620

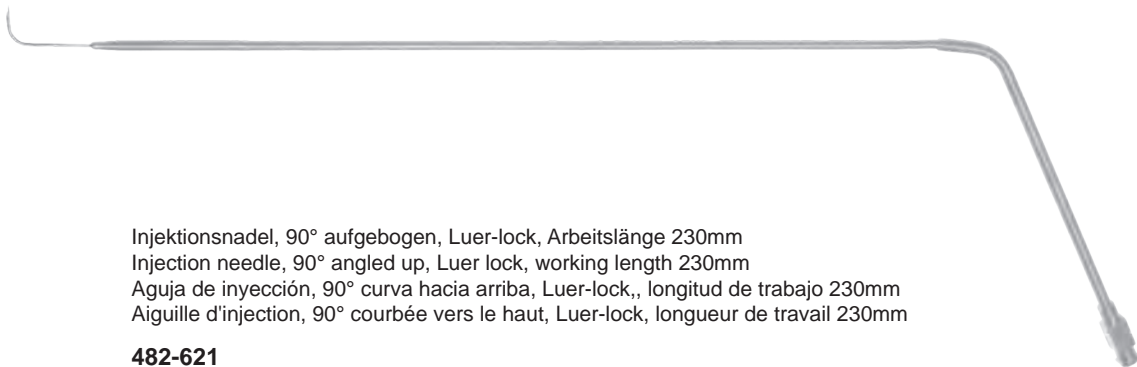

Injektionsnadel, 90° aufgebogen, Luer-lock, Arbeitslänge 230mm
Injection needle, 90° angled up, Luer lock, working length 230mm
Aguja de inyección, 90° curva hacia arriba, Luer-lock,, longitud de trabajo 230mm
Aiguille d'injection, 90° courbée vers le haut, Luer-lock, longueur de travail 230mm

482-621



Rohrschaft Ø 1,5mm
 tubular shaft Ø 1,5mm
 tubo tubular Ø 1,5mm
 tige tubulaire Ø 1,5mm



Arbeitslänge 350mm working length 350mm longitud de trabajo 350mm longueur de travail 350mm	gerieft serrated estriada striée
485-6600	gerade / straight recta / droite



Arbeitslänge 350mm working length 350mm longitud de trabajo 350mm longueur de travail 350mm	gerieft, gefenestert serrated, fenestrated estriada, fenestrada striée, fenêtrée
485-6610	gerade / straight recta / droite



Arbeitslänge 350mm working length 350mm longitud de trabajo 350mm longueur de travail 350mm	Hechtmaul pike mouth shape boca forma de lucio forme bouche de brochet
485-6620	gerade / straight recta / droite



Arbeitslänge 350mm working length 350mm longitud de trabajo 350mm longueur de travail 350mm	runder Löffel Ø 3,0mm round cups Ø 3,0mm cuchara redonda Ø 3,0mm cuillère ronde Ø 3,0mm
485-6630	gerade / straight recta / droite



485-6640	aufgebogen / curved up curva hacia arriba / courbée vers le haut
-----------------	---



485-6640H	aufgebogen horizontal öffnend / curved up horizontal opening curva hacia arriba horizontal / courbée vers le haut ouverture horizontale
------------------	--



485-6650	rechts gebogen / curved right curva derecha / courbée droite
-----------------	---



485-6660	links gebogen / curved left curva izquierda / courbée gauche
-----------------	---

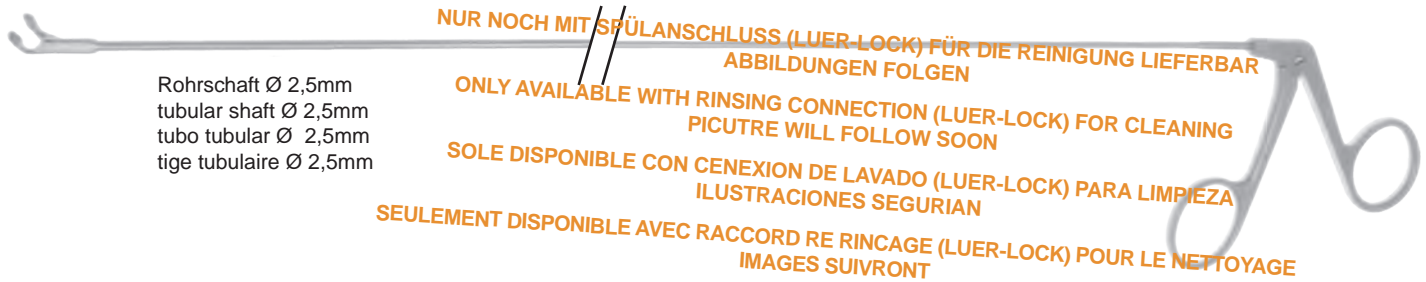

gerieft serrated estriada striée	Arbeitslänge / working length longitud de trabajo / longueur de travail		
	400mm	500mm	600mm
gerade / straight recta / droite	485-6810	485-6812	485-6814



gerieft, gefenstert serrated, fenestrated estriada, fenestrada striée, fenêtrée	Arbeitslänge / working length longitud de trabajo / longueur de travail		
	400mm	500mm	600mm
gerade / straight recta / droite	485-6820	485-6822	485-6824



Hechtmaul pike mouth shape boca forma de lucio forme bouche de brochet	Arbeitslänge / working length longitud de trabajo / longueur de travail		
	400mm	500mm	600mm
gerade / straight recta / droite	485-6830	485-6832	485-6834



runder Löffel Ø 4,0mm round cups Ø 4,0mm cuchara redonda Ø 4,0mm cuillère ronde Ø 4,0mm	Arbeitslänge / working length longitud de trabajo / longueur de travail		
	400mm	500mm	600mm

gerade / straight recta / droite	485-6840	485-6842	485-6844
-------------------------------------	-----------------	-----------------	-----------------



aufgebogen / curved up curva hacia arriba / courbée vers le haut	485-6850	485-6852	485-6854
---	-----------------	-----------------	-----------------



aufgebogen horizontal öffnend / curved up horizontal opening curva hacia arriba horizontal / courbée vers le haut ouverture horizontale	485-6850H	485-6852H	485-6854H
--	------------------	------------------	------------------



rechts gebogen / curved right curva derecha / courbée droite	485-6860	485-6862	485-6864
---	-----------------	-----------------	-----------------



links gebogen / curved left curva izquierda / courbée gauche	485-6870	485-6872	485-6874
---	-----------------	-----------------	-----------------





Arbeitslänge / working length longitud de trabajo / longueur de travail			ovaler Löffel 3x8mm oval cup 3x8mm cuchara ovalada 3x8mm cuillère ovale 3x8mm
400mm	500mm	600mm	
485-6880	485-6882	485-6884	gerade / straight recta / droite



Arbeitslänge / working length longitud de trabajo / longueur de travail			ovaler Löffel 4x6mm oval cup 4x6mm cuchara ovalada 4x6mm cuillère ovale 4x6mm
400mm	500mm	600mm	
485-6890	485-6892	485-6894	gerade / straight recta / droite



Arbeitslänge / working length longitud de trabajo / longueur de travail			ovaler Löffel 4x8mm oval cup 4x8mm cuchara ovalada 4x8mm cuillère ovale 4x8mm
400mm	500mm	600mm	
485-6900	485-6902	485-6904	gerade / straight recta / droite



Arbeitslänge / working length longitud de trabajo / longueur de travail			Universalmaul zur Probeexzision und Fremdkörperentfernung Universal for biopsy and foreign bodies removal Boca universal para biopsia y extraccion de cuerpos extraños Mors universelle pour biopsie et extraction de corps étrangers
400mm	500mm	600mm	
485-6910	485-6912	485-6914	gerade / straight recta / droite

WEERDA

Tracheal Spekulum, Gesamtlänge 190mm
Tracheal speculum, total length 190mm
Especulo traqueal, longitud total 190mm
Spéculum trachéal, longueur totale 190mm

481-730



KOCHER

Kropfsonde, mit Loch, Gesamtlänge 165mm
Goitre dissector, with hole, total length 165mm
Sonda bocio, con hueco, longitud total 165mm
Sonde goitre, avec trou, longueur totale 165mm

203-101



TROUSSEAU

Trachealdilator, mit 2 Blättern
Tracheal dilator, with 2 blades
Dilatador traqueal, con 2 hojas
Dilatateur trachéal, avec 2 lames

481-700 Gesamtlänge 145mm / total length 145mm
longitud total 145mm / longueur totale 145mm

481-702 Gesamtlänge 120mm / total length 120mm
longitud total 120mm / longueur totale 120mm



LABORDE

Trachealdilator, mit 3 Blättern
Tracheal dilator, with 3 blades
Dilatador traqueal, con 3 hojas
Dilatateur trachéal, avec 3 lames

481-720 Gesamtlänge 150mm / total length 150mm
longitud total 150mm / longueur totale 150mm

481-722 Gesamtlänge 125mm / total length 125mm
longitud total 125mm / longueur totale 125mm

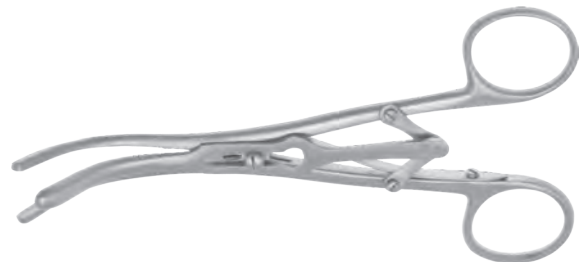

SCHOEMAKER

Kropfschere, Gesamtlänge 150mm
Goitre scissors, total length 150mm
Tijera bocio, longitud total 150mm
Ciseaux goitre, longueur totale 150mm

125-561



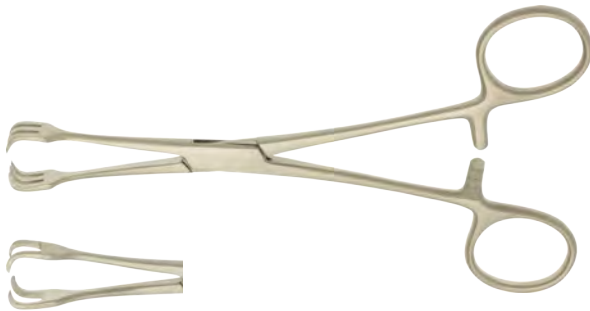

LAHEY

Kropffasszange, Gesamtlänge, 155mm
Goitre grasping forceps, total length 155mm
Pinza de aprehension bocio, longitud total 155mm
Pince de préhension goitre, longueur totale 155mm

301-456 3x3 Zähne / 3x3 teeth
3x3 dientes / 3x3 griffes

301-455 2x2 Zähne / 2x2 teeth
2x2 dientes / 2x2 griffes



BOSE

Tracheotomiehäkchen, spitz, Gesamtlänge, 160mm
Tracheal hook, sharp, total length 160mm
Gancho de traqueotomia, agudo, longitud total 160mm
Crochet de trachéotomie, pointu, longueur totale 160mm

480-525 links, left, izquierda, gauche

480-526 rechts, right, derecha, droit



SCHOENBORN

Schilddrüsenhaken, Gesamtlänge, 210mm
Thyroid retractor, total length 210mm
Gancho para tiroides, longitud total 210mm
Crochet pour goitre, longueur totale 210mm

160-439 13x6mm



Trachealhaken, spitz, enge Biegung, Gesamtlänge, 160mm
Tracheal retractor, sharp, small curved, total length 160mm
Gancho traqueal, agudo, curva ajustada, longitud total 160mm
Crochet trachéal, pointu, courbure étroite, longueur totale 160mm

160-381 1 zinkig, 1 prong, 1 diente, 1 griffe

160-382 2 zinkig, 2 prongs, 2 dientes, 2 griffes

160-383 3 zinkig, 3 prongs, 3 dientes, 3 griffes

160-384 4 zinkig, 4 prongs, 4 dientes, 4 griffes



Trachealhaken, stumpf, enge Biegung, Gesamtlänge, 160mm
Tracheal retractor, blunt, small curved, total length 160mm
Gancho traqueal, romo, curva ajustada, longitud total 160mm
Crochet trachéal, mousse, courbure étroite, longueur totale 160mm

160-391 1 zinkig, 1 prong, 1 diente, 1 griffe

160-392 2 zinkig, 2 prongs, 2 dientes, 2 griffes

160-393 3 zinkig, 3 prongs, 3 dientes, 3 griffes

160-394 4 zinkig, 4 prongs, 4 dientes, 4 griffes

ELCON

MEDICAL INSTRUMENTS GmbH

D - 78532 Tuttlingen Dr. Karl-Storz-Str. 26
Tel: +49 7461 9281-0
info@elcon-medical.de www.elcon-medical.com